

Interactive System インタラクティブシ テム特論(3)

Hiroyuki Kajimoto
kajimoto@hc.uec.ac.jp
Twitter ID kajimoto
Hash tag #itsys

(案内) ヒューマンメディア工房コンテスト

調布祭オープンキャンパスの一環

<http://www.hc.uec.ac.jp/activity/hmstudio/index.html>

開催日：11/19(土) 午後

時間(仮)：

1-4時：4F工房部屋にて展示

4:30～：201にて発表会

締め切り：11/17(木) 16:30

提出先：西6-7階H科事務室

詳細は掲示

「実はこんなものを作っている」

「実はこんな活動をしている」

という発表を期待。

学科・専攻を問いません。特に新しい研究ネタをこっそり出して反応を見る、という使い方も院生はお勧め(例年あり)



Schedule

- 10/14 講義 Lecture
- 10/21 講義 Lecture
- 10/28 (Conference)
- 11/04 講義 Lecture
- 11/11 (Conference)
- 11/18 (Chofu-sai)
- 11/25 講義 Lecture
- 12/02 講義 Lecture
- 12/09 (Conference)
- 12/16 講義 Lecture／発表論文選択
- 12/23 (holiday)
- 01/06 講義 Lecture
- 01/13 講義 Lecture
- 01/20 発表 Presentation
- 01/27 発表 Presentation
- 02/03 発表 Presentation
- 02/10 発表 Presentation

Outline of the lecture

1. 人間計測手法／Measuring Human
2. 視覚／Human Vision System
3. 視覚センシング／Visual Sensing
4. 視覚ディスプレイ／Visual Display
5. 聴覚、聴覚インタフェース／Auditory Interface
6. 触覚、触覚インタフェース／Tactile Interface
7. 力覚、力覚インタフェース／Haptic Interface
8. 移動感覚インタフェース／Locomotion Interface

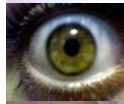

TODAY's TOPIC



- 光学の基礎 / Basics of Optics
- 光学素子 / Optical Elements
- 3次元イメージング / 3D Image Sensing

Structure of a Camera

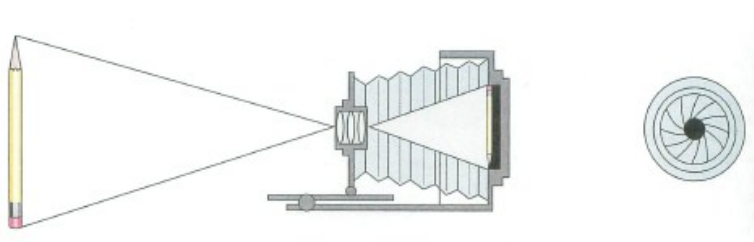

- Lens
- Iris
- Shutter
- Film

レンズ / Lens

- Convex Lens

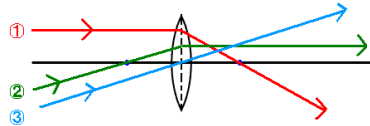

- Concave Lens

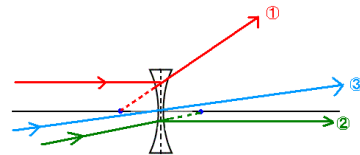

凸レンズの原理 / Convex Lens Principles

- Rule1 : Ray that runs parallel to the lens axis passes through focal point.

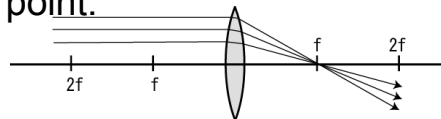

- Lemma : Ray that passes focal point becomes parallel to the lens axis.

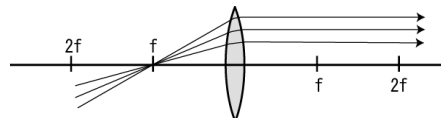

- Rule2 : Ray that passes lens center does not change its direction.

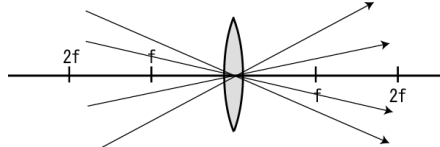

実像 / Real Image

- The rays **really** comes out from the **image**.

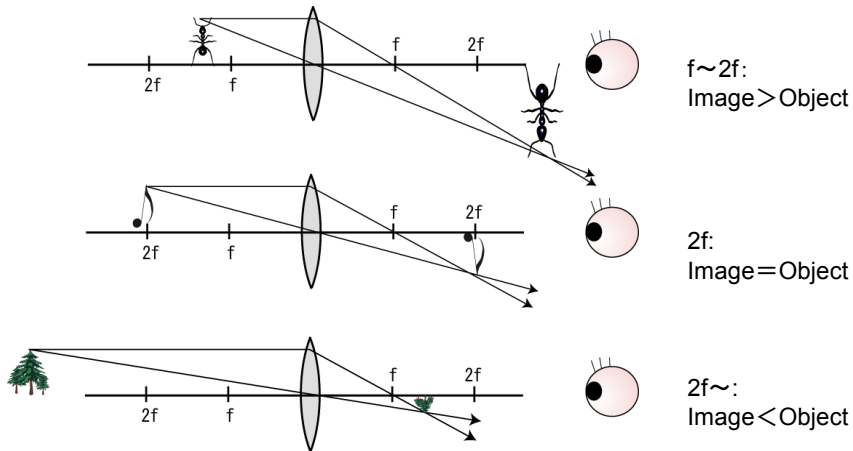

虚像 / Virtual Image

- The ray does **not really** come out from the image, but **virtually** (=has the same effect as if) comes out from the image.

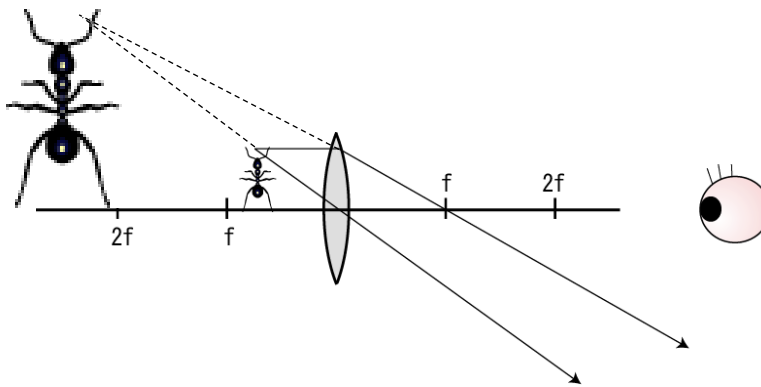

Object distance $<$ f : Virtual Image

虚像と実像



凹レンズの原理 / Concave Lens Principles

- Fixed Rule 1 : Ray that runs parallel to the axis refracts, and runs as if it comes from back focal point.

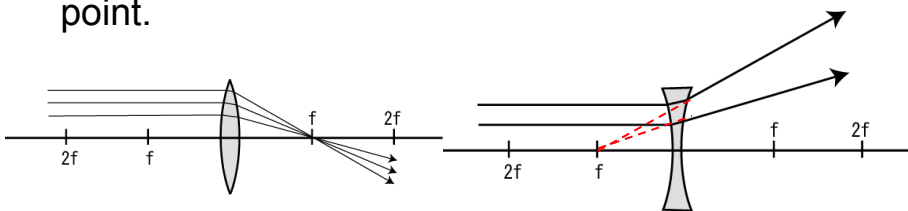

- Only virtual image can be formed.

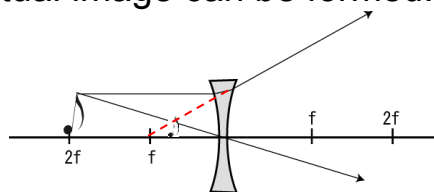

像とは何か What is **Image**?

クイズ／Quiz

You are wandering
dark space.

Now, One directional,
parallel rays fill the
whole space.

What do you see?

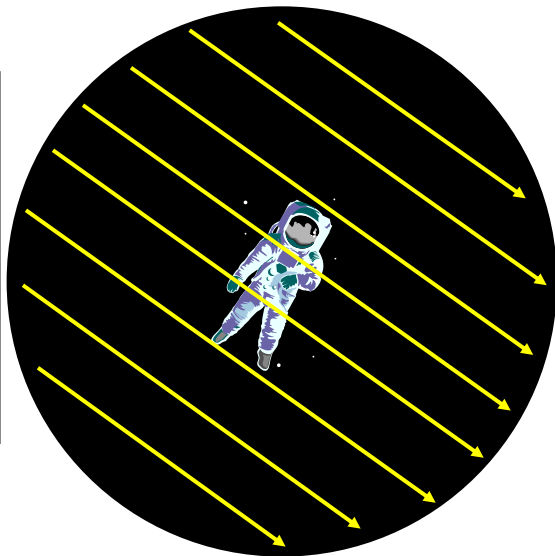

像とは何か？ / What is **IMAGE**?

Image is a
virtual/real
light source
from which
rays come out
omnidirectionally.

「像」の理解は簡単ではない

Do you really understand refraction **IMAGE**?

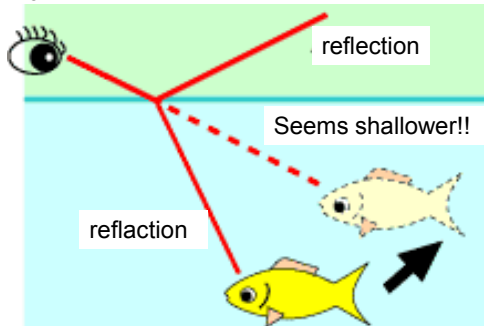

Figures in elementary school textbooks:
Only one line explains “shallow fish”.

- Is one line **enough** to explain the fish position?
- Is **oblique incident angle** necessary?

クイズ / Quiz

What we know: Due to refraction, objects in water seem shallower.

Question: What about **horizontal distance**?

- (A) A little far
- (B) A little near
- (C) Does not change

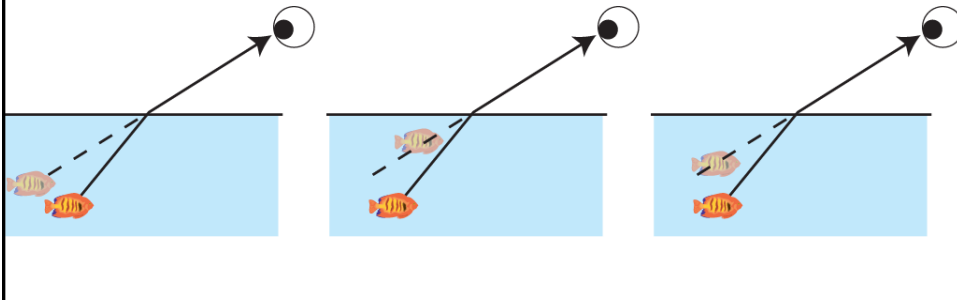

クイズからわかること / What the quiz shows is

“One line” does not explain everything.

Remember the definition of “IMAGE”,
and think about omnidirectional rays
by using 2 rays.

It gives the position of “IMAGE”

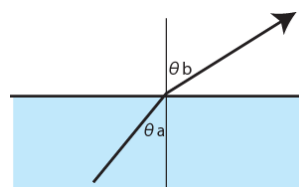
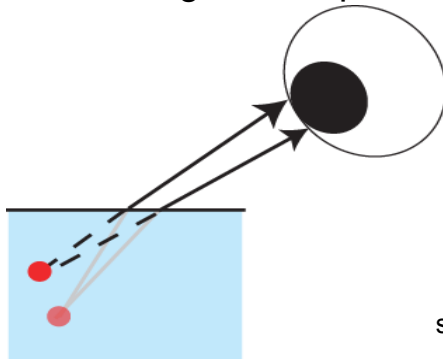

Snell's law:
 $\sin\theta_b / \sin\theta_a = n$ (index of refraction)

「浅く見える」ためには「斜めから見る」必要なし
 Oblique incident angle is not necessary for "Shallow" perception.

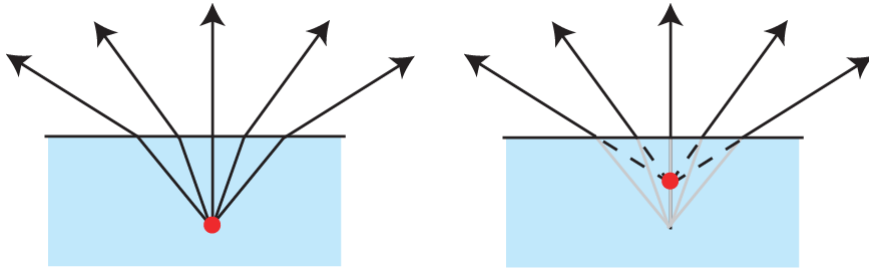

Looking from overhead, it still looks shallower.

IMAGE redefinition:

- Ideally... **Any rays** from a point can be regarded as rays from different point.
- Practically... Rays from a point to eye's pupil can be regarded as rays from different point.

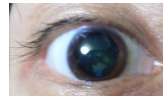

「屈折像」に関する誤解

Misunderstanding of refraction phenomenon.

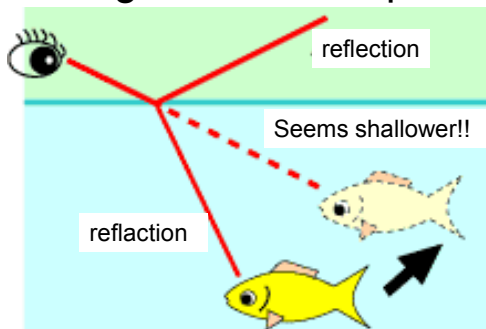

“Single line” can explain refraction
phenomenon, but not **IMAGE**.

IMAGE should emit rays to any
 directions, like real object .

そもそも「反射像」を理解しているか？

Do you really understand reflection **IMAGE**?

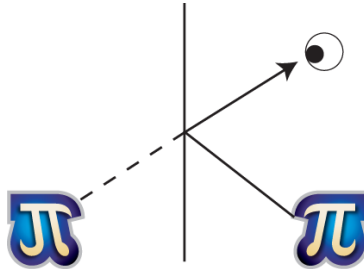

Single ray line can explain reflection **phenomenon**,
but can not explain reflection **IMAGE**.

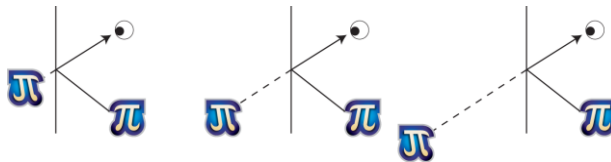

Which one is correct? →can not be judged by single line.

ミラーはミラクル／Mirror is Miracle

By flat mirror, (almost) ANY rays from a point
can be regarded as rays from a different point,
which obeys the pure definition of IMAGE.

In this case, the image is "**Virtual Image**"

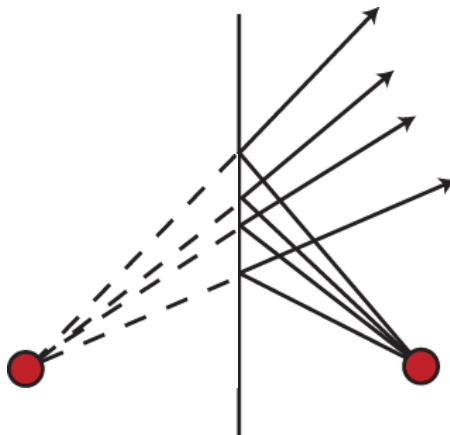

平面ミラーの奇跡: 他の可能性は?

Is Flat Mirror Really Miracle?

Is there any other surface shape,
that can convert “any rays from a point”
into the “rays from a different point”.

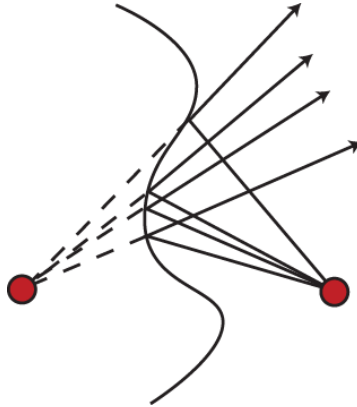

楕円鏡 / Elliptic Mirror

- Generates Real Image
- Used in oven at space,
to melt metals and make alloys

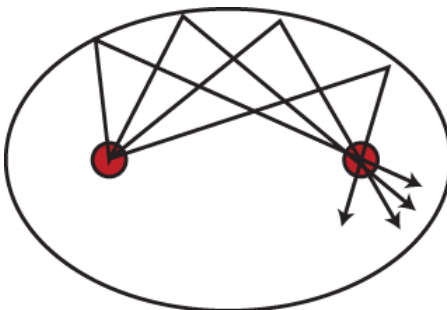

双曲面鏡／Hyperbolic Mirror

- Generates Virtual Image.
- Flat mirror is the special case of Hyperbolic Mirror.
- Used for surveillance camera.

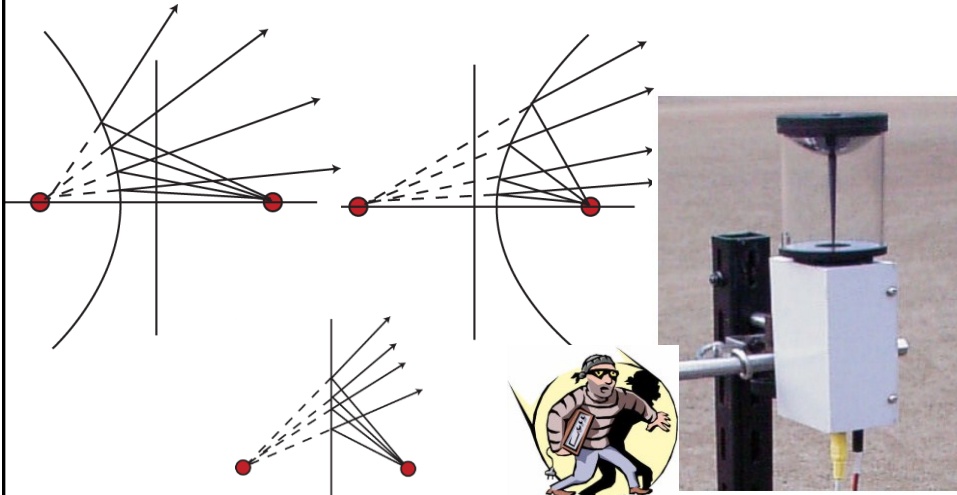

放物面鏡／Parabolic Mirror

- Converge parallel rays to a focus.
- Change rays from focus to parallel beam
- Works like lens.

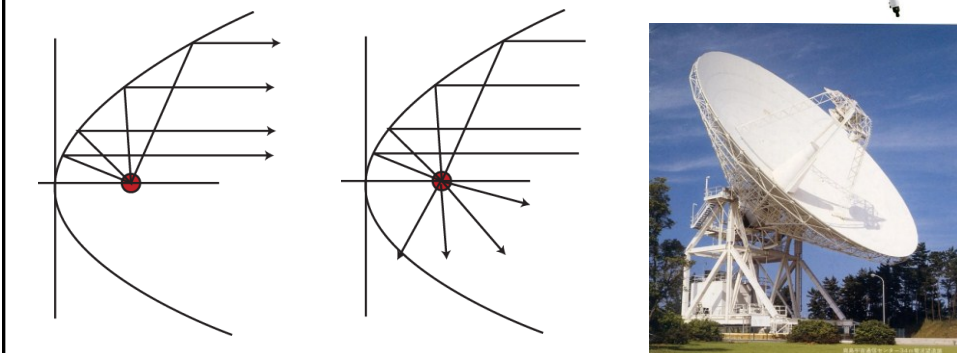

レンズの「像」に戻って / Go back to the lens image

We draw **two representative rays**,
But actually, there are **infinite** number of rays,
and seems as if the rays come out from the image.

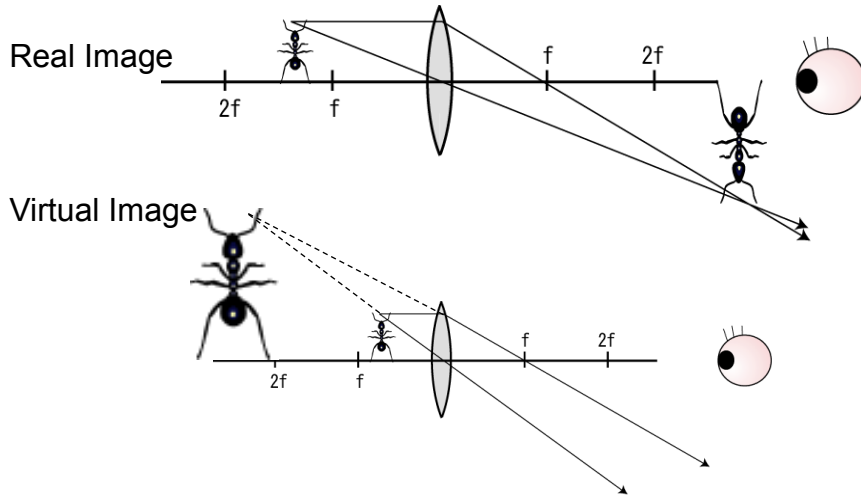

HMDは虫眼鏡 / HMD and Magnifying glass

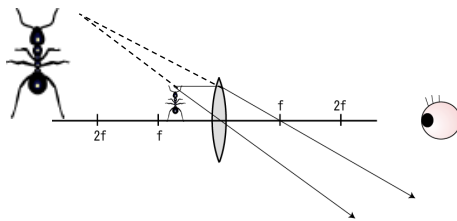

• Head Mounted Display

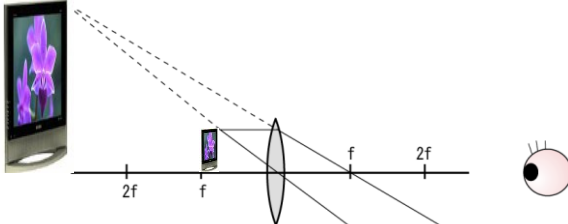

Purpose: change the distance from eye to the image

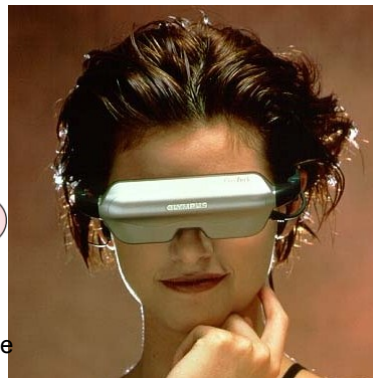

(復習／review)輻輳・調節矛盾
Vergence-accomodation conflicts



- Accommodation & vergence are slightly coupled.
- Stereo display problem:
 - Accommodation=constant
 - Vergence = variable
 ⇒ **Severe Fatigue**

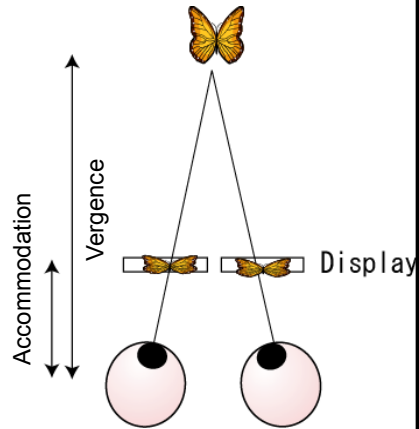

望遠鏡／telescope

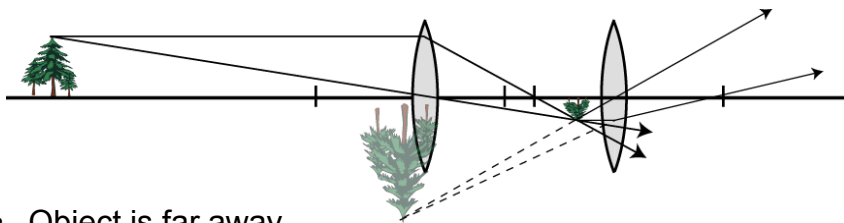

- Object is far away
- Real-image by objective lens (対物レンズ)
- Converted to Virtual-image by ocular lens (接眼レンズ)
- 双眼鏡／binocular glasses

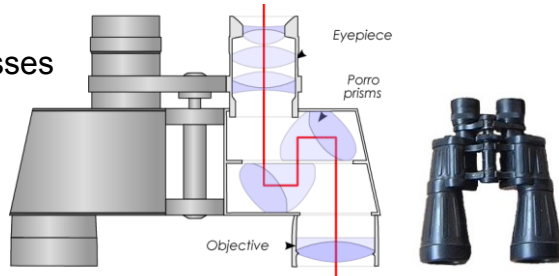

顕微鏡／Microscope

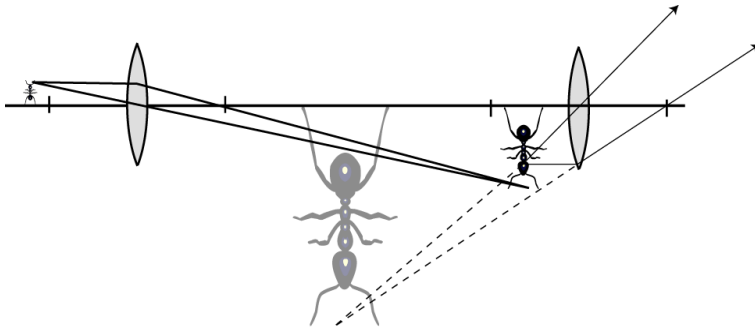

- Object is close to focus of objective lens.

被写界深度／Depth of Field



- 左：被写界深度が浅い／Left: Shallow
- 右：被写界深度が深い／Right: Deep

被写界深度／Depth of Field

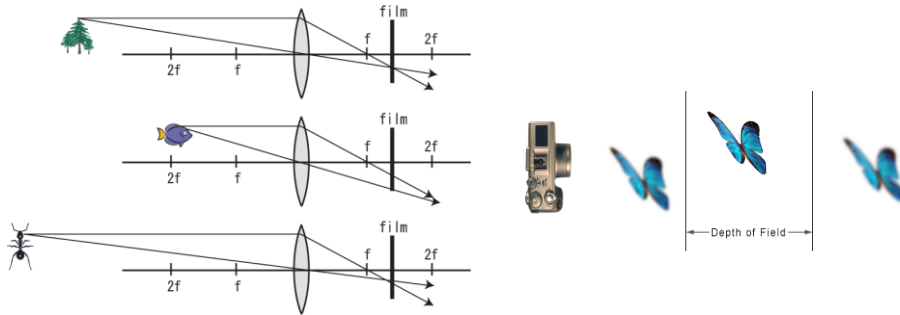

- 焦点の合う距離は一つだけ。他の距離ではすべてボケる。
When distance between lens and film is fixed, object distance is fixed. Other objects always blur.
- しかし、ボケが人間に判別できないレベルの範囲であれば許容できる⇒この許容範囲のことを被写界深度と呼ぶ。
Depth of Field=Acceptable distance

被写界深度／Depth of Field

- 被写界深度は、絞りと焦点距離に依存
 - Depth of field is related to aperture & focal length
- 絞り／Aperature (=レンズの実質的な大きさ/lens size)
 - Large aperture = Shallower Depth of Field
 - Minimum Aperature = Pinhole Camera
 - 応用: 視力の良くなるアイマスク

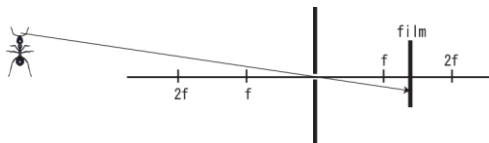

- 焦点距離／Focal Length
 - 短い(=広角)ほど深い(極端な例:魚眼レンズ)

被写界深度:コンパクトカメラの大問題

- レンズが小さい=ピンホールに近い.
- 被写界深度を浅く出来ない.



- こういう写真が取れない

(参考)被写界深度・焦点の「後処理」

- Synthetic Refocusing
- 距離によって焦点を結ぶ位置が異なる
- もしやってくる光線を「方向も含めて」記録できれば後処理可能

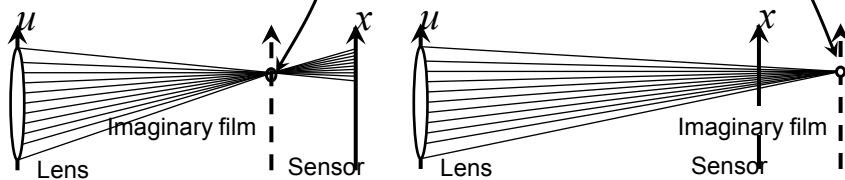
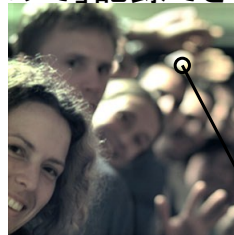

<https://www.lytro.com/renng-thesis.pdf>

(参考)被写界深度・焦点の「後処理」:考え方

無数のピンホール(個数=カメラの画素数)+より高密度な画素で「方向も含めた」光線群を記録。

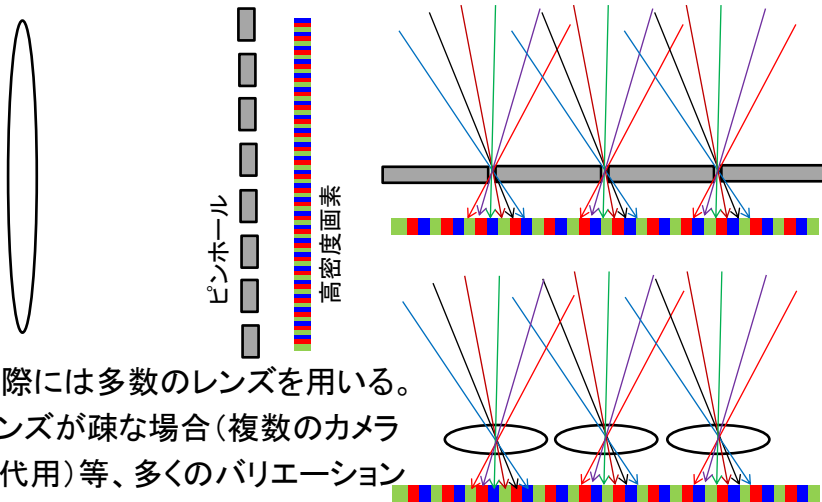

製品: Lytro(2012?)

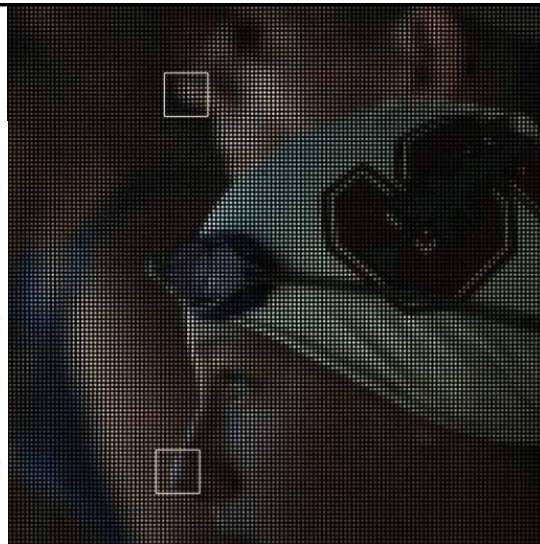
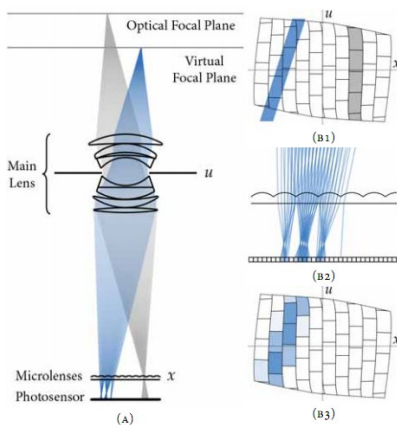

<https://www.lytro.com/renng-thesis.pdf>

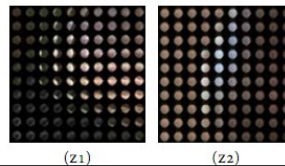

製品 : Lytro(2012?)



<http://www.youtube.com/watch?v=7babck2GH3I>

A hand is holding a white, cube-shaped camera with a black front face. The front face has a 4x4 grid of 16 small, circular lenses. The background is a grid of many small images of a teddy bear. At the top of the grid, the text "www.fraps.com" is visible. At the bottom of the grid, there is a dark blue banner with the text "ProFUSION 25" on the left, "The World's First PCI Express Camera" in the center, and "ViewPLUS" on the right. Below the banner is a URL: <http://www.viewplus.co.jp/product/camera/profusion25.html>

屈折率、曲率と焦点距離

Refraction factor, curvature and focal length

- 球面レンズの場合の近似式 / For spherical lens

$$\frac{1}{f} = (N-1) \left(\frac{1}{R_1} + \frac{1}{R_2} \right) - \frac{(N-1)^2 d}{NR_1 R_2}$$

- f : 焦点距離, N : ガラスの屈折率, R_1, R_2 : レンズの曲率半径, d : レンズの厚み
- 薄いレンズでは第二項は無視することが多い。

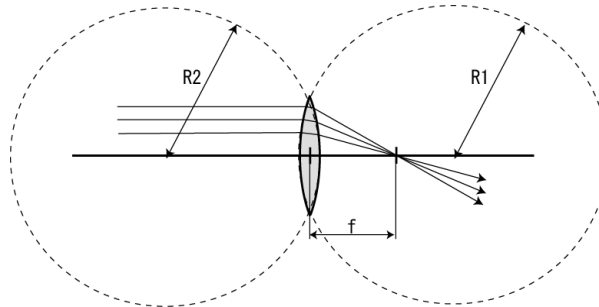

What happens if $N=2$?

- $N=2$, $R_1=R_2=R$, $d=2R$ を代入

$$\frac{1}{f} = (N-1) \left(\frac{1}{R_1} + \frac{1}{R_2} \right) - \frac{(N-1)^2 d}{NR_1 R_2} = (2-1) \left(\frac{1}{R} + \frac{1}{R} \right) - \frac{(2-1)^2 2R}{2R^2} = \frac{1}{R}$$

$$\therefore f = R$$

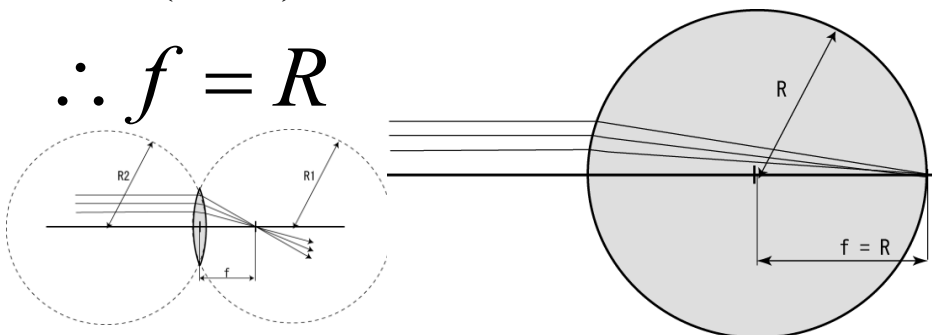

- 球面の反対側表面に焦点を結ぶことを意味する
- Meaning focal point is just at the back side of the lens

再帰性反射材／Retro-reflector



- 屈折率2のガラスビーズは、光が来た方向に帰る
- 球面内側表面での「鏡面」反射は本質ではない。拡散反射しても再帰性反射は生じる（赤目現象と同じ。当然鏡面反射の方が強い反射光を得られるが）

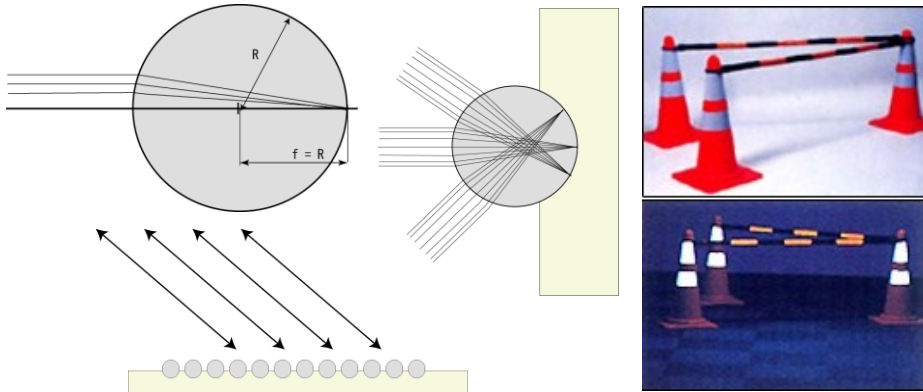

再帰性反射材／Retro-reflector



TODAY's TOPIC



- 光学の基礎／Basics of Optics
- **光学素子／Optical Elements**
- 3次元イメージング／3D Image Sensing

その他インタラクティブシステムでよく用いられる光学素子

Other optical elements for interactive system

- フレネルレンズ／Fresnel Lens
- レンチキュラレンズ／Lenticular Lens
- ハーフミラー／Half Mirror
- 偏光板／Polarization Plate
- プライバシーフィルタ
- 波長フィルタ／Low-pass/High-pass/Band-pass Filter
- 光ファイバ／Optical Fiber

インタラクティブ技術特論

フレネルレンズ / Fresnel Lens

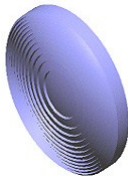

通常のレンズの光路図
Figure of rays passing through
a conventional convergent lens

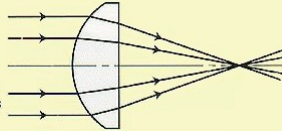

光が直進するレンズ内部
Portion of a conventional convergent
lens where rays travel straight

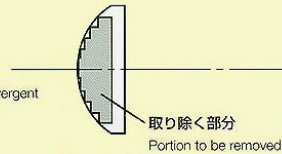

フレネルレンズの光路図
Figure of rays passing through
a Fresnel convergent lens

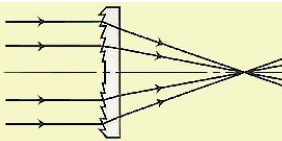

- 薄い平板状のため、
大面積のレンズが安価、
軽量に作成可能
- 照明光学系に多く使用
(カメラのストロボ、
灯台)
- フレネルミラーもある
(表面に蒸着)

(参考) オーバーヘッドプロジェクタ

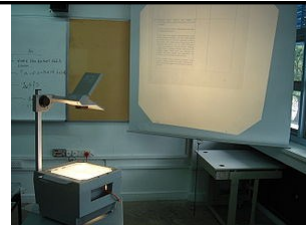

ミラー: 光路屈曲+反転

レンズ: 実像の生成(反転)

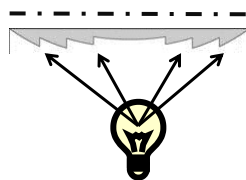

OHPシート

フレネルレンズ:
平行光ないし集約光の生成
(コリメータ)
光源

レンチキュラレンズ／Lenticular Lens

- かまぼこ型レンズの群れ
- マイクロレンズアレイの1次元版



<http://www.youtube.com/watch?v=K2j0iPmJXXc>

(参考)リアプロジェクションTV

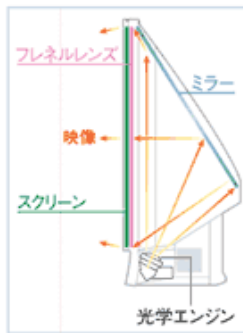

<「HD-61/52MD60」の構造図>

<http://joshinweb.jp/av/project4.html?CKV=051104&ACK=REP>

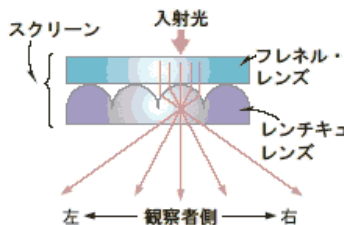

<http://techon.nikkei.co.jp/article/WORLD/20060306/114225/>

- フレネルレンズ: 入射光の平行化
- レンチキュラレンズ: 左右方向の視認性の向上

(参考) レンチキュラレンズを用いた歩行誘導
 / Walk Navigation by Lenticular Lens

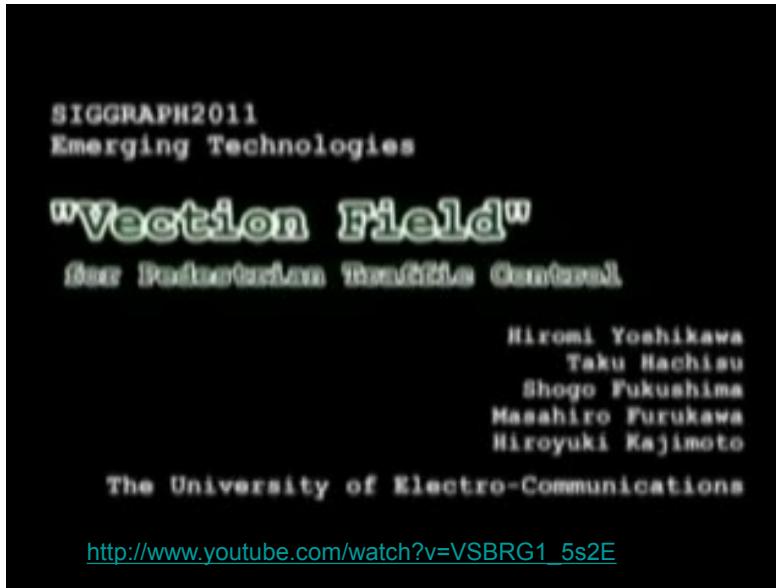

ハーフミラー(ビームスプリッター・マジックミラー)
 / Half Mirror, Beam Splitter, Magic Mirror

全反射+透過の両方の性質を持つ

- 平面蒸着タイプ
- プリズムタイプ
- 特殊タイプ

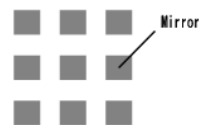
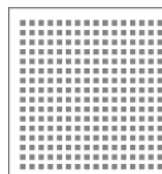
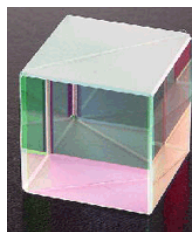
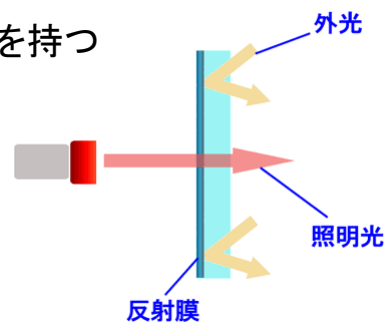

(参考) ハーフミラーのデジタルサイネージ応用



(参考) ハーフミラーを用いたインタラクティブAR

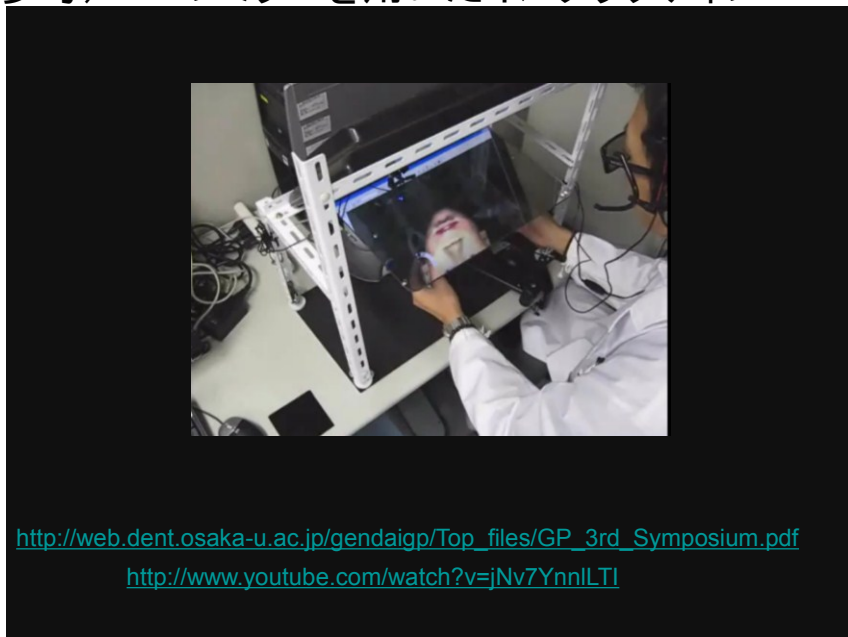

(参考)ダイクロイックミラー: 特定波長のみ反射



<http://www.youtube.com/watch?v=c4u404dZgGk>

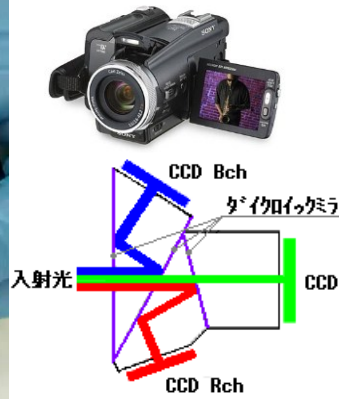

- 3板式CCDカメラ等で色分解に使用
 - コールドミラー: 可視光を反射, 赤外を透過
 - ホットミラー: コールドミラーの逆

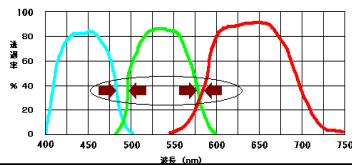

偏光板 / Polarization Plate

- 直線偏光
- 円偏光

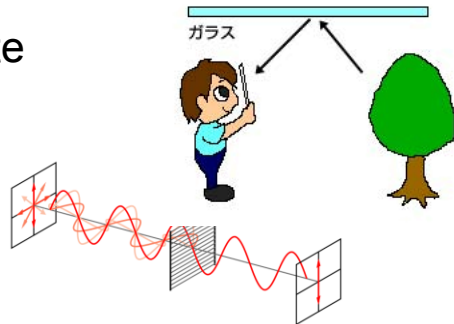
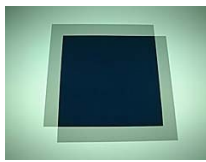

<http://www.youtube.com/watch?v=E9qpb0v5Hw&feature=related>

<http://www.youtube.com/watch?v=ytaBaD4Lewc>

"Polarization of Light"
UCLA Department of Physics and Astronomy

参考：液晶パネル

液晶分子の性質を利用した液晶パネルの仕組み

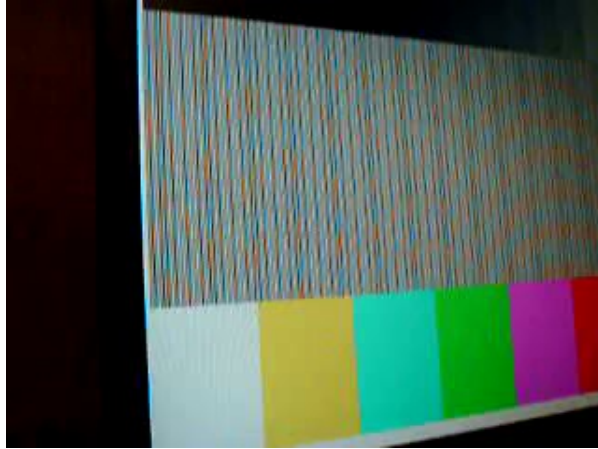
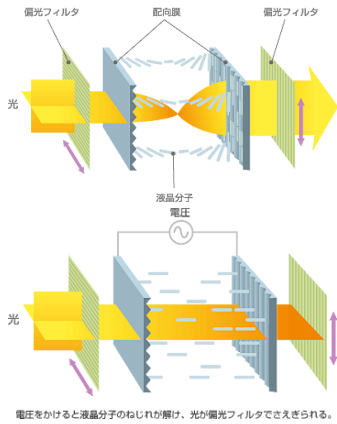

<http://www.tdk.co.jp/techmag/knowledge/200702/index.htm>

http://www.youtube.com/watch?v=Sdv0J57_U5g

プライバシーフィルタ

- 深さ方向の微小な柵により覗き見防止
- 撮影時の照明光入射防止など

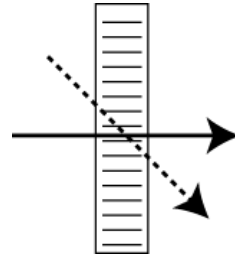

http://www.youtube.com/watch?v=_UAiVJRrQZ0

波長フィルタ

／Low-pass/High-pass/Band-pass Filter

- 照明光による反射光のみ撮影したい
- 太陽光の影響を避けたい
- ハイパスフィルタ(赤外防止フィルタ)
 - カメラレンズに必ず付属。
 - 赤外光でホワイトバランスが崩れるのを防ぐ。



- ローパス(ロングパス)フィルタ(赤外透過フィルタ、IRフィルタ)
 - 赤外照明による撮影
 - 水蒸気等による拡散が少なくなり、風景がクリアになる
- バンドパスフィルタ

(参考)IRフィルタの利用

- 水蒸気等による拡散が少なくなり、風景がクリアに
- 血管をクリアに観察



<http://www.youtube.com/watch?v=S2eexdjIHSU>

<http://www.youtube.com/watch?v=l7qq6XPDVO8&NR=1>

(参考) 赤外線を用いた(自作/格安)タッチパネル

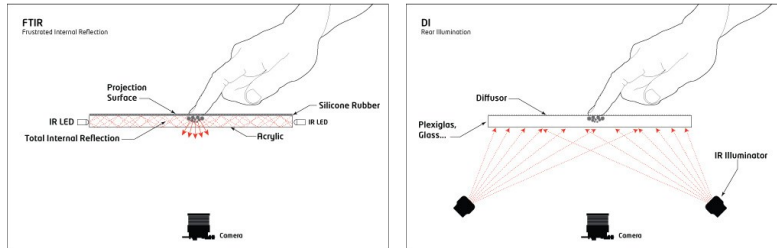

<http://iad.projects.zhdk.ch/multitouch/>

http://www.youtube.com/watch?v=XTTe8_HXdLM

光ファイバ/Optical Fiber

- ファイバースコープ/Fiber Scope
 - 撮像素子が入り込めない微細な場所で使用
- テレビ石/Ulexite
 - 光ファイバの束. 自然の鉱石
 - Bundle of Optical Fiber. Natural



http://www.youtube.com/watch?v=XTTe8_HXdLM

<http://www.geocities.co.jp/Technology/2931/tvs.html>

TODAY's TOPIC



- 光学の基礎／Basics of Optics
- 光学素子／Optical Elements
- 3次元イメージング／3D Image Sensing

3次元イメージング／3D Image Sensing

- 3D Display requires 3D data acquisition
 - 光レーダー法／Optical Radar
 - タイムオブフライト／Time of Flight
 - モワレ法／Moire Fringe Analysis
 - 照度差ステレオ法／Photometric Stereo
 - 光切断法／Light Section
 - レンズ焦点法／Shape from Focus
 - パッシブステレオ法／Passive Stereo
 - 視体積交差法／Visual Cone Intersectio



光レーダー法／Optical Radar

- Put laser beam to target.
- Use reflection time and phase-lag
- Use rotating mirror for scanning
- (good) Most accurate
- (bad) Most expensive, requires time for scan



タイムオブフライト／Time of Flight (TOF)

- Similar to optical radar.
- Each CMOS image sensing element has timer

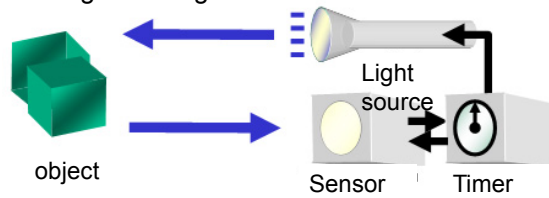

モワレ法／Moire Fringe Analysis

- Project stripes
- See the projected image through the other stripes (do the same in PC)
- Depth is converted to density.

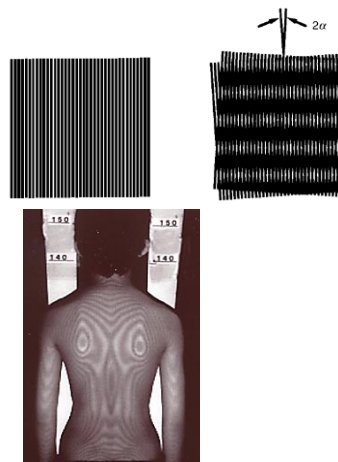

Observation

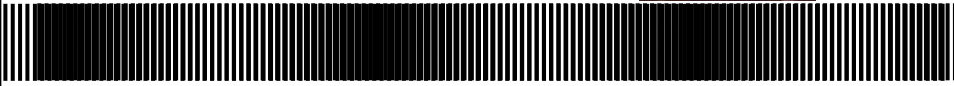

Projection

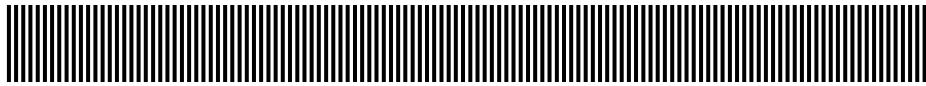

照度差ステレオ法／Photometric Stereo

- Prepare 3 or more light sources.
- Object's gradient is calculated by Luminance change
- Shape is calculated by integrating gradient.
- Quite simple.
- Object surface's characteristics (reflectance) are necessary.

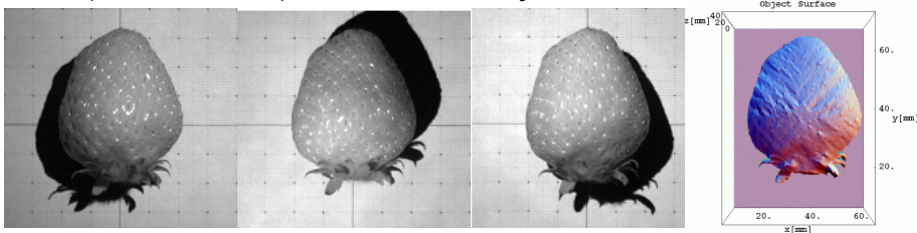
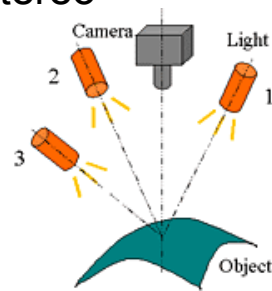

光切断法／Light-section method

- So called “triangular survey”
- Project line image
- Capture from different position.
- Disparity = distance
- (good)Accurate and simple,
- (bad) requires time.
- Not line, but **coded-pattern** is projected for fast acquisition.

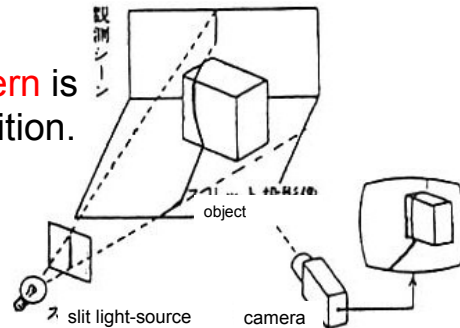

Light Section Method



Real-time Projection & 3D retrieval

(Song Zhang et al., Harvard, 2006)

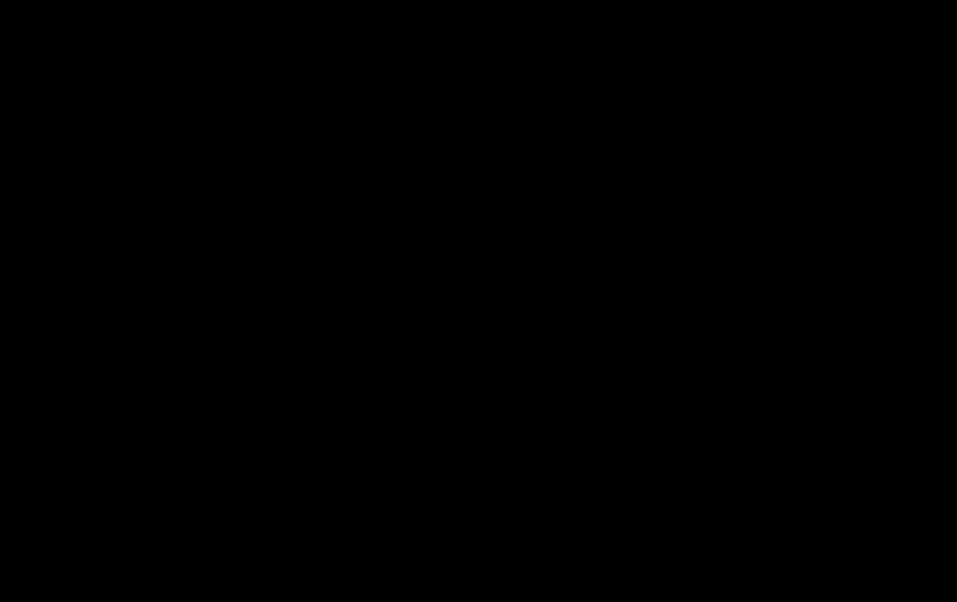

レンズ焦点法 / Shape from Focus

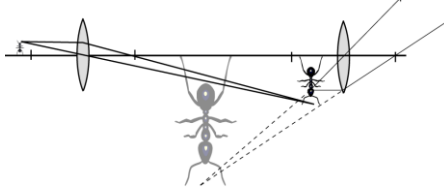

- Shift the lens and move focus distance
- Use different focus levels to obtain a sequence of object images.
- Quite rough, when used for scenery. (focal depth is large)
- Quite accurate, when used in microscopy. (focus is severe)

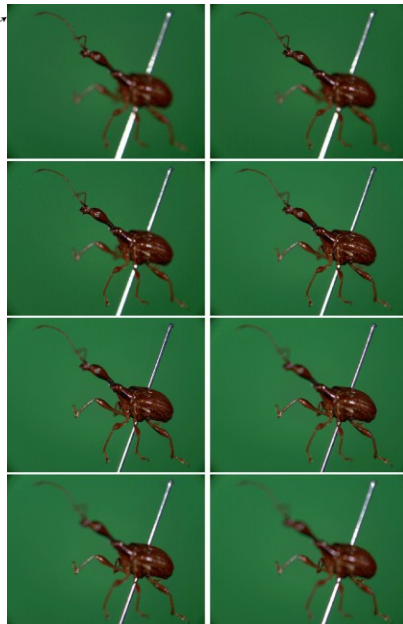

パッシブステレオ法 / Passive Stereo

- Two or more cameras
 - Just like Human do
 - Use disparity. Triangular Method.
 - (bad) Disparity measurement requires huge calculus.
 - (bad) Mis-calculation of the disparity occasionally.
 - (good) Can be used outdoors.



Passive Stereo

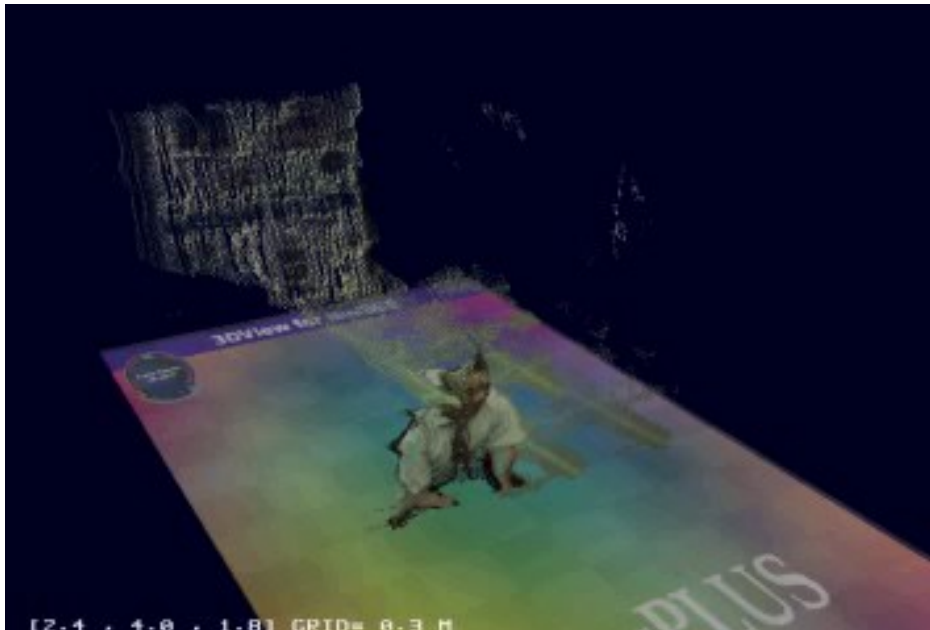

視体積交差法／Visual Cone Intersection

- Simple method when image can be captured from all-round.
- “trim” the box by using silhouettes.
- (bad) Concave part cannot be reconstructed.

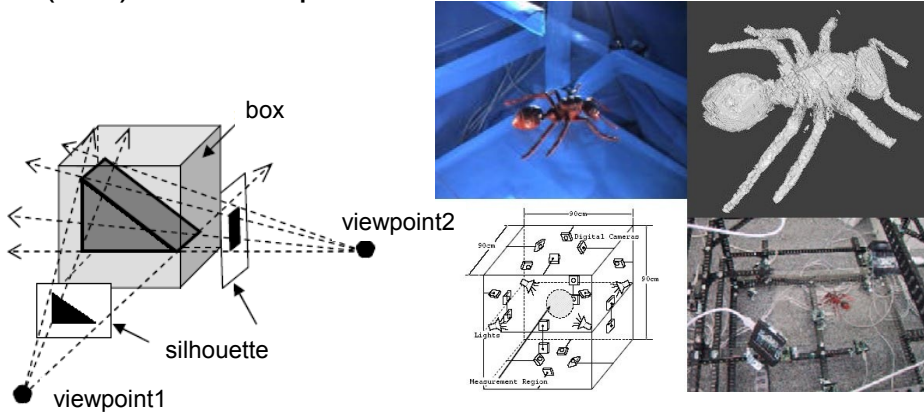

Xbox Kinect

- イスラエルの会社3DVとPrime Senseを買収
 - 3DV: Time of Flight
 - Prime Sense: 模様 of 投影 ⇒ 結局採用

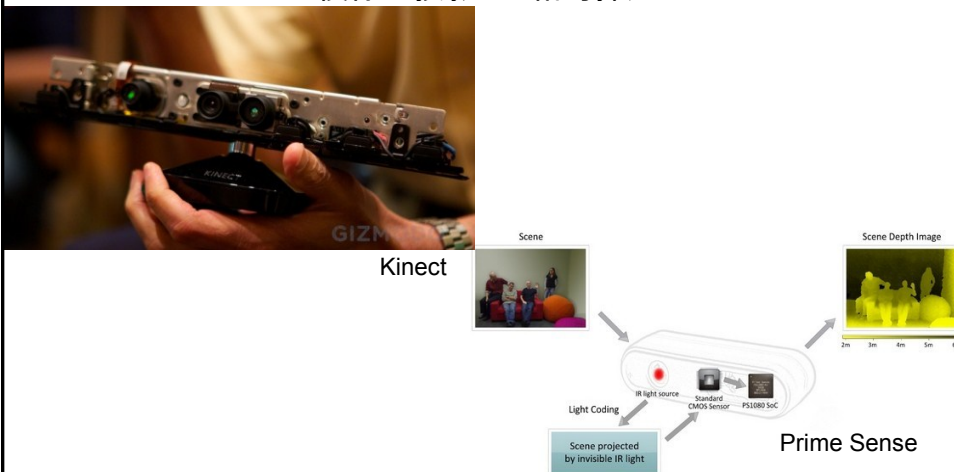

Xbox Kinectの照射パターン

<http://www.youtube.com/watch?v=nvvQJxgykcU>

本当に3D画像は必要か？

Re-consideration: Is 3D information necessary?



- Final goal is to display 2 images to the eyes.
- 3D shape **reconstruction** is actually, not necessary.
- Images from **arbitrary direction** is sufficient.

現実解(1): カメラ自体をリアルタイムに動かす
 Practical Solution(1): Move the camera.

- Synchronize the motion of the user and the robot so that image from arbitrary direction is obtained.
- (bad) Real-time control is necessary.

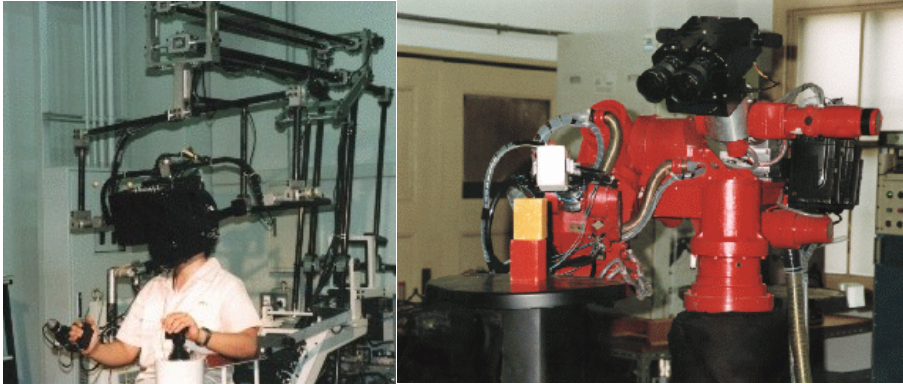

現実解(2): カメラ(視点)をたくさん用意する
 Practical Solution(2): Use Many cameras.

- Method used in "MATRIX"



試作システム



TODAY's SUMMARY

- Basics of Optics
 - Lens
 - Real Image, Virtual Image
 - Refraction Image, Reflection Image
 - Mirror (flat, elliptic, hyperbolic, parabolic)
- 3D Image Sensing
 - True 3D reconstruction
 - Optical Radar, Time of Flight, Moire Fringe Analysis, Photometric Stereo, Light Section, Shape from Focus, Passive Stereo, Visual Cone Intersection
 - Practical Approach for interactive system



小テスト／Mini Test 次回開始まで

以下の全てに100字以内程度で解答せよ／Answer all questions within 50 words

1. 実像について説明せよ Explain real image.
2. 虚像について説明せよ Explain virtual image
3. 楕円鏡について説明せよ Explain elliptic mirror
4. 双曲面鏡について説明せよ Explain hyperbolic mirror
5. 放物面鏡について説明せよ Explain parabolic mirror
6. 被写界深度と絞りの関係を述べよ Explain relationship between depth of field and aperture size
7. 再帰性反射材について説明せよ Explain retroreflector.
8. フレネルレンズについて説明せよ Explain fresnel lens.
9. ハーフミラーについて説明せよ Explain half mirror
10. 偏光板について説明せよ Explain polarization plate
11. 光レーダー法について説明せよ Explain optical radar method
12. タイムオブフライトについて説明せよ Explain time of flight method
13. モワレ法について説明せよ Explain moire fringe analysis
14. 照度差ステレオ法について説明せよ Explain photometric stereo method
15. 光切断法について説明せよ Explain light section method.
16. レンズ焦点法について説明せよ Explain shape from focus
17. パッシブステレオ法について説明せよ Explain passive stereo method
18. 視体積交差法について説明せよ Explain visual cone intersection method.