

Interactive System インタラクティブ システム特論 (1)

Hiroyuki Kajimoto
kajimoto@uec.ac.jp
Twitter kajimoto



言語 / Language

- 講義は日本語、資料は日本語/英語。
- Lecture in Japanese, handouts in Japanese/English.



Self Introduction: Research field = Virtual Reality



<https://kaj-lab.jp>

Necessary Knowledge for the research

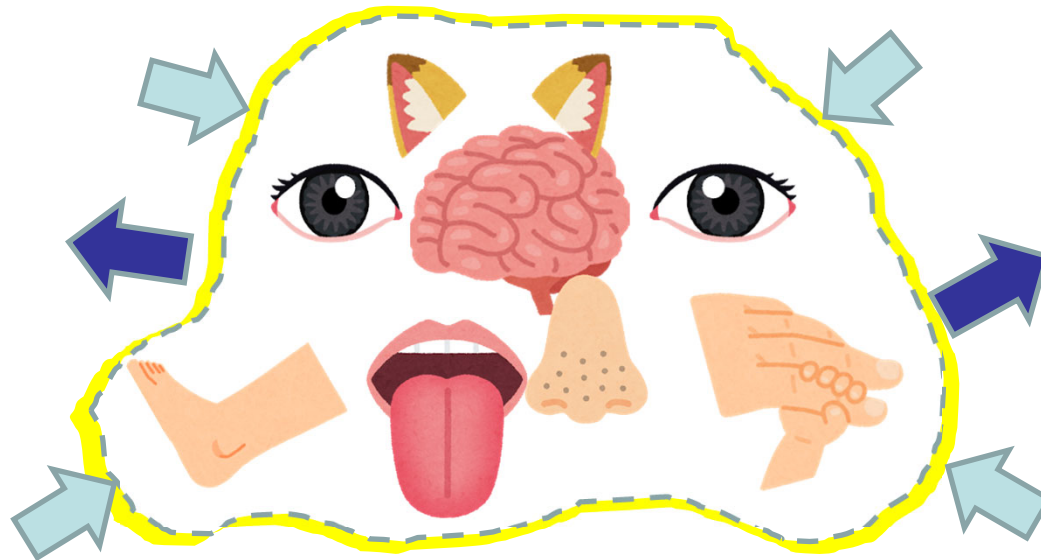

- ヒトの特性／Human perception
- 最新技術(センサ)／Today's sensing technology
- 最新技術(ディスプレイ)／Today's display technology

This Lecture aims to roughly sketch
“optimal design method based on human perception”



Outline of the lecture



1. 人間計測手法／Measuring Human
2. 視覚／Human Vision System
3. 視覚センシング／Visual Sensing
4. 視覚ディスプレイ／Visual Display
5. 聴覚、聴覚インタフェース／Auditory Interface
6. 触覚、触覚インタフェース基礎／Tactile Interface Basics
7. 触覚、触覚インタフェース応用／Tactile Interface Applications
8. 力覚、力覚インタフェース／Haptic Interface
9. 移動感覚インタフェース／Locomotion Interface



Schedule

講義番号/No.	講義日/Date	内容/Contents	pdf	video	レポート締切日/Report Deadline
1	4/05	人間計測手法/Measuring Human	[📄 pdf] 2023年版	video 📄	4/12
-	4/12	出張のため休講/Class cancelled			
2	4/19	視覚/Human Vision System	[📄 pdf] 2023年版	video 📄	4/26
3	4/26	視覚センシング/Visual Sensing	[📄 pdf] 2023年版	video 📄	5/3
4	5/10	視覚ディスプレイ/Visual Display	[📄 pdf] 2023年版	video 📄	5/17
-	5/17	出張のため休講/Class cancelled			
5	5/24	聴覚、聴覚インタフェース/Auditory Interface	[📄 pdf] 2023年版	video 📄	5/31
-	5/31	出張のため休講/Class cancelled			
6	6/7	触覚、触覚インタフェース/Tactile Interface	[📄 pdf] 2023年版	video 📄	6/14
7	6/14	触覚、触覚インタフェース2/Tactile Interface2	[📄 pdf] 2023年版	video 📄	6/21
8	6/21	力覚、力覚インタフェース/Haptic Interface	[📄 pdf] 2023年版	video 📄	6/28
9	6/28	移動感覚インタフェース/Locomotion Interface	[📄 pdf] 2023年版	video 📄	7/5
-	-	プレゼンビデオ提出締切/Presentation video upload	[📄 pdf]	-	7/12
-	-	プレゼンビデオ評価 (1) /Watch group 1 video	-	-	7/19
-	-	プレゼンビデオ評価 (2) /Watch group 2 video	-	-	7/26
-	-	プレゼンビデオ評価 (3) /Watch group 3 video	-	-	8/2

休講日に関して、2回程度追加のビデオ視聴をお願いすることを検討しています。
Google Classroomのアナウンスに注意してください。



小テスト/ Mini Test

- 講義の目的の一つが「基礎知識を得ること」なので、各回小テストを行います。
- Google Formに入力する形で回答。リンクはgoogle classroomに書かれています。
- 回答テキストをフォームにコピーして提出してください
- 締め切り:一週間後

- E-mail report based quizzes are done every time.
- Answer by Google form. The link is at the Google classroom
- Deadline: One week after the class



実験レポート/ Mini Experiment Report

- 講義の時々で、小テスト以外に簡単な実験課題を課します。紙工作でものを作る、心理実験をやる、という程度のものであります。
- Google FormにPDFをアップロードする入力する形で提出してください
- 締め切り:小テストと同様、一週間後
- Sometimes in this lectures, simple experimental tasks are assigned in addition to mini test, such as psychophysical experiment and paper craft.
- Please submit it in the form of a PDF file to be uploaded to Google Form.
- Deadline: One week later, same as the quiz



発表/ Presentation

Your Video Presentation is required.

- 英語の論文を一つ読み, その内容を発表.
(読む論文の学会は後日詳述)

Read a paper and upload your presentation video.
(candidate papers will be announced)

– 発表は5分以内. Youtubeの限定公開リンクとして提出

- 発表は受講者全員で評価

The presentation is evaluated by all attendees

- 1. 発表内容に対する理解度
- 2. 発表用資料(パワーポイント)の分かりやすさ
- 3. 発表の分かりやすさ
- 4. 質問に対する受け答え
- 5. 総合的な印象



評価/ Evaluation

- 点数=小テスト、レポート(50%)+発表(50%)
- ただし発表をすることが評価の前提条件
- Evaluation=Mini Test&Report (50%) + Presentation (50%)
- Presentation is required.



Handouts on the web

<https://kaji-lab.jp/ja/index.php?people/kaji/interactive>

- 現在は2022年版がおかれています。変えていきます。**レポートの内容も変更されるので、2022年度版でレポートすることは避けてください。**
- Temporary, 2022 Japanese version. Will be replaced progressively. **The contents of the report will be replaced, so please wait for the 2023 version.**

-本講義は対面講義ですが、2021年版の動画は置いたままにします

-This class is on-site. However, you can also check the youtube video of 2021 class.

-初回(今回)は紙で配布しますが、次回からは事前に授業ページにアクセスしてダウンロードしてください。ノートPC等の持ち込み可

-The handout will not be distributed next time. Please download the pdf before the class starts. Using laptops during class is OK.



Today's Topic:

人間計測手法 / Measuring Human



ヒトの計測:

- インタラクティブシステムの**構成要素**
- インタラクティブシステムを**評価するため**にも必須

Measurement of human action/reaction

- To be used **as parts of** the interactive system
- To **evaluate** the system



人間計測手法／Measuring Human

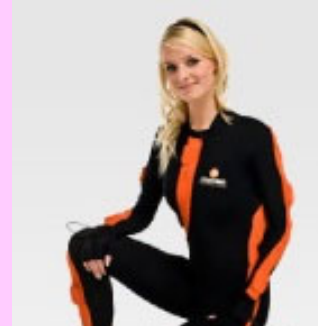
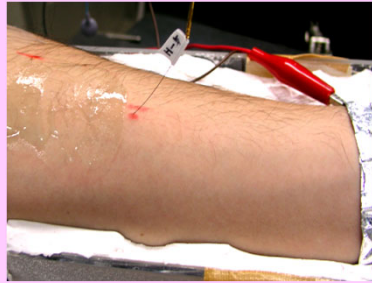

意志から行動までの「どの経路を測るか」で5つの段階
Five layers, *from our initial will to our perception.*

- 脳活動計測／Measure **brain activity**.
- 神経・筋活動計測／Measure **nerve activity**.
- 自律神経系計測／ Measure **autonomic nerve** related phenomenon.
- 運動計測／Measure **motion**.
- 心理物理実験／Ask the user (**psychophysics**)



History of Brain Function Observation(1)

- Theory of localization of brain function:
 - 1909: **ブロードマン** Brodmann made “map” of the brain by visual observation. (microscope)
 - WWI: Better guns = many patients with “partial” brain damage

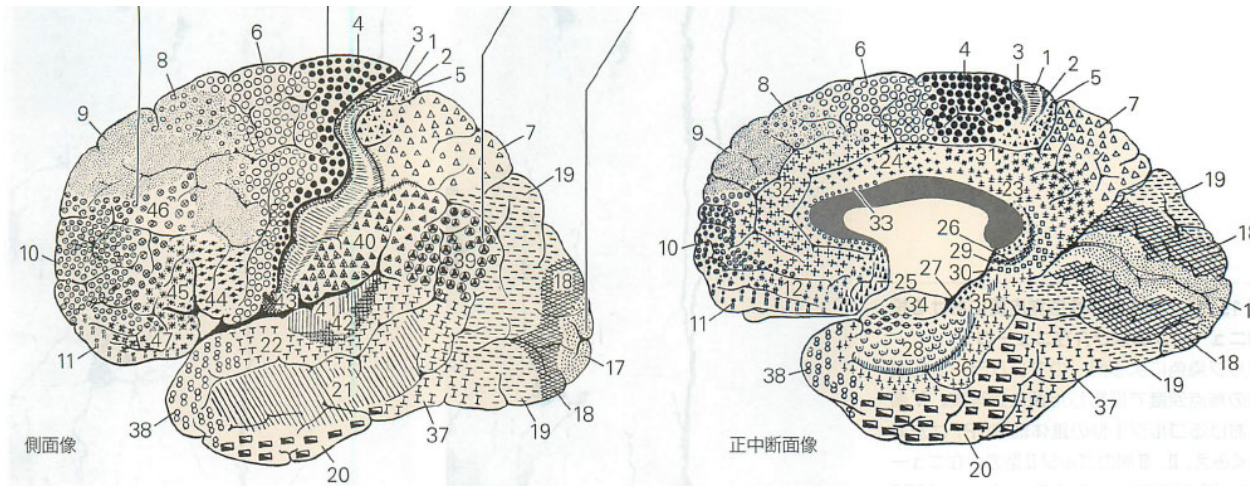

カンデル神経科学(Principles of Neural Science)
<https://www.medsci.co.jp/kandel/syousai/index.html>

Broadmann's map:
52 regions of the cortex defined based on organization of cells.



History of Brain Function Observation(2)

- 1933: **ペンフィールド** Penfield
Before Brain surgery for epilepsy, he stimulated brain directly by electrical needle.
while the patients were awake.
Result: Many functional region were found, including memory, sensory, and action.
- 1940: **ロボトミー** Lobotomy
Cut frontal lobe of the brain for mental disease, especially for violent patients.
Result: Became calm, but also lacks emotion ⇒ Frontal lobe seems to be related to “emotion”
- 1960: X-ray CT gave clear view of the brain, without surgery.

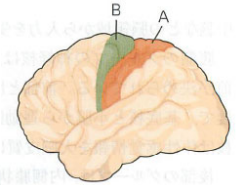

A 感覚のホムンクルス

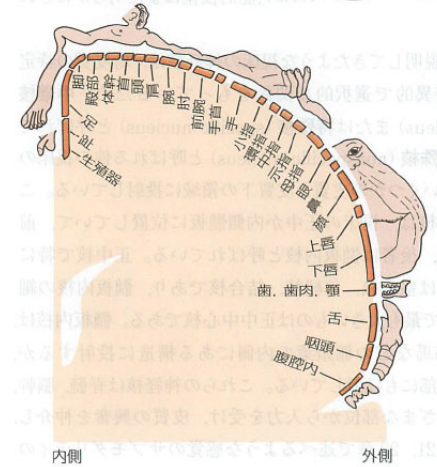

カandel神経科学(Principles of Neural Science)

<https://www.medsci.co.jp/kandel/syou sai/index.html>



Lobotomy (Wikipedia)

<https://en.wikipedia.org/wiki/Lobotomy>



脳機能計測／Measurement of Brain Function

- Not the measurement of brain, but brain function. Must be done during some work. (see, touch, think)
- State-of-the-art measurement technologies are used.
 - Measure “Electrical Activity”
 - 脳波／EEG (brain wave), 1929～
 - 脳磁／MEG, 1972～
 - Measure “Blood Flow”
 - fMRI (functional MRI), 1973～
 - PET, 1965～
 - NIRS, 1994～
 - Active method
 - Use magnetic stimulator



EEG (Brain Wave)

- EEG: Electroencephalogram
- 21~60 electrodes on the skull skin.
- Good points
 - Cheap!
 - Very fast (ms)
- Bad points
 - Low spatial resolution.
 - Skin-electrode conductance is unstable.
 - Can measure “surface”, but cannot measure “deep region”
- Still used in many interactive systems

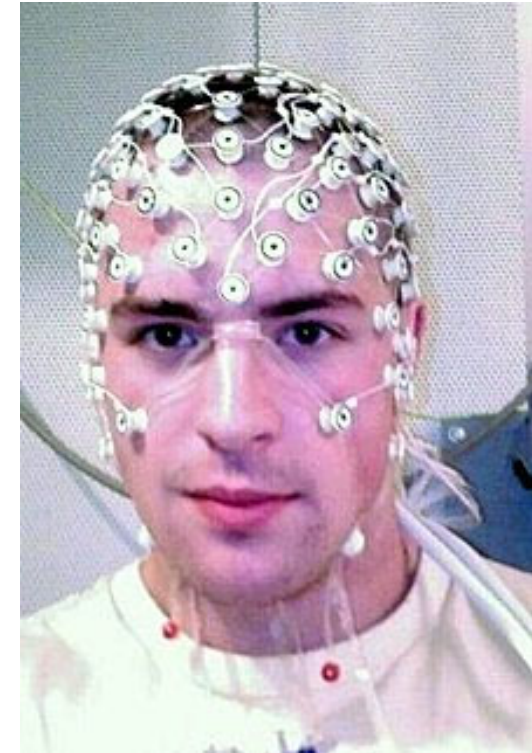

EEG (Wikipedia)

<https://en.wikipedia.org/wiki/Electroencephalography>



MEG

- MEG:Magnetoencephalography
- Similar to EEG, but measure “magnetic field” induced by electrical current.
- **Very, very tiny magnetic field** (about $1/10^8$ of the earth’s magnetic field)
- Superconducting technology is used. (SQUID:Superconducting Quantum Interference Device)

- Good points
 - Very Fast (similar to EEG)
 - Can measure deep region. (magnetic field penetrates everything) .
- Bad points
 - Surface sensors = 2D
 - Current sources = 3D mathematically very difficult to solve (almost impossible)

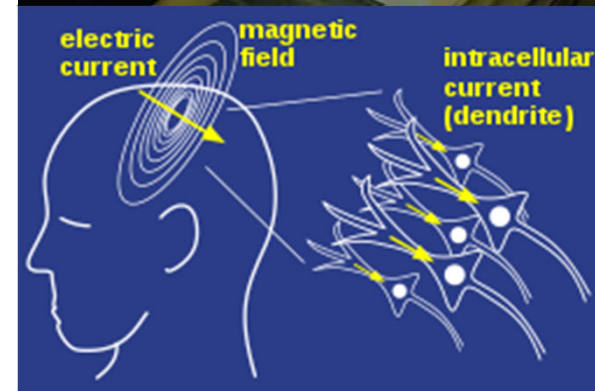

MRI(核磁気共鳴画像法)

- MRI:Magnetic Resonance Imaging
 - Very strong magnetic field make protons to “emit” electromagnetic waves.
 - By measuring this waves, can obtain 3D structures.
- Good points (compaired to X-ray CT)
 - No X-ray (=good for body)
 - Bone is not an obstacle
 - 3D data are obtained (X-ray CT:2D)
- Bad points
 - Very strong magnet (3T-): metal cannot be carried on.
 - Takes a few seconds for a single shot (now improving).
- Current standard for “brain imaging”

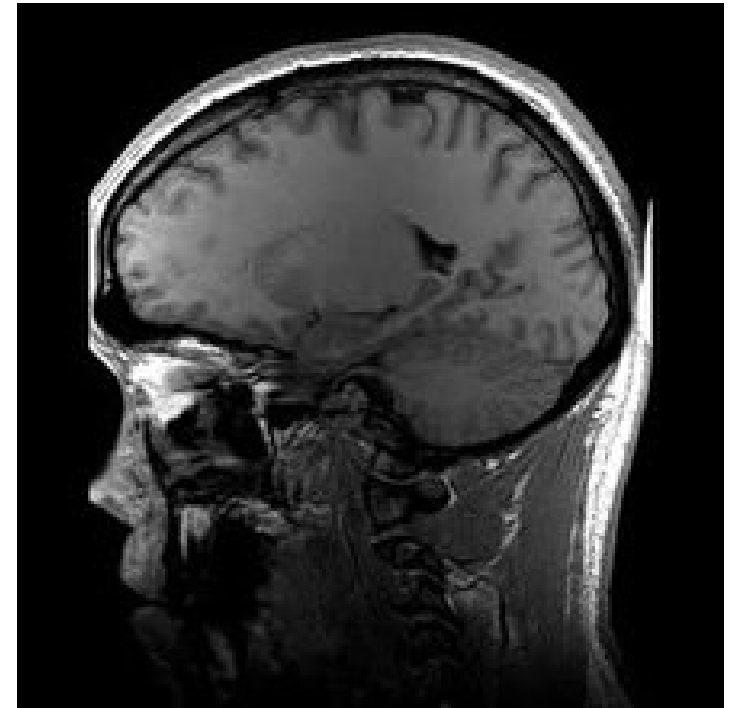

MRI (Wikipedia)

https://en.wikipedia.org/wiki/Magnetic_resonance_imaging



100fps MRI

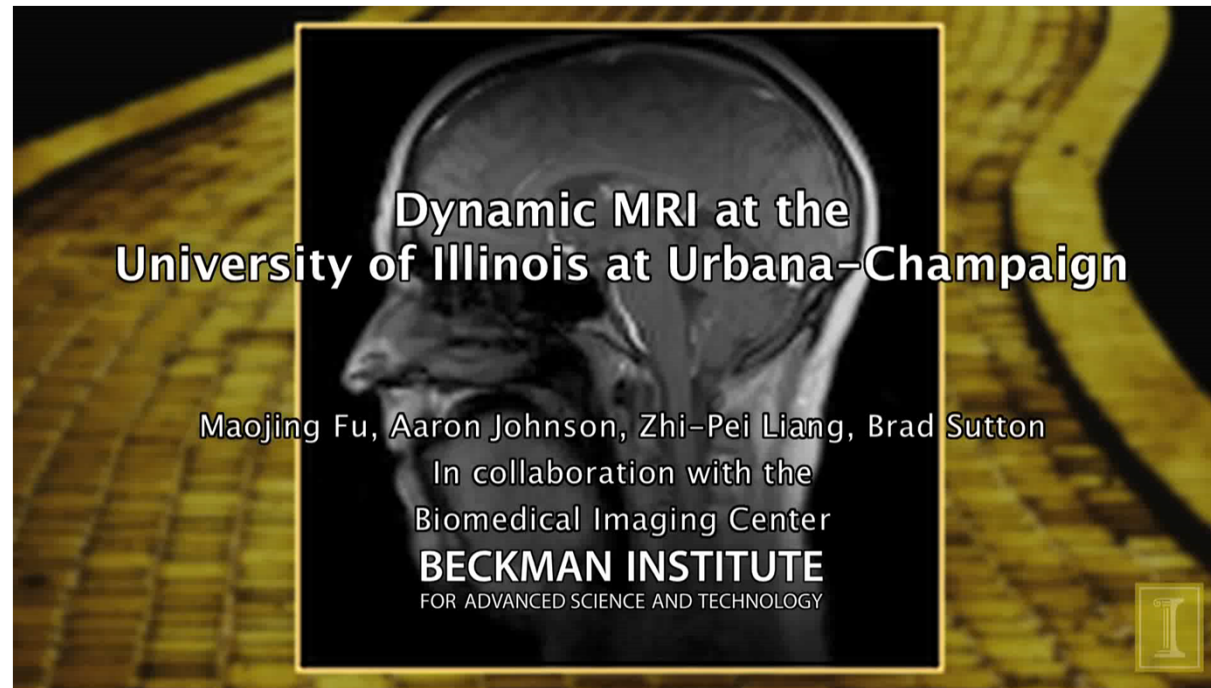

- <http://japanese.engadget.com/2015/04/23/100fps-mri/>
- 秒間100コマの撮影が可能なMRI技術を開発。
- Maojing Fu, Bo Zhao, Christopher Carignan, Ryan K. Shosted, Jamie L. Perry, David P. Kuehn, Zhi-Pei Liang, and Bradley P. Sutton "High-resolution dynamic speech imaging with joint low-rank and sparsity constraints" (), Magnetic Resonance in Medicine, 2015



Exploding MRI



<http://www.youtube.com/watch?v=uxjOn5fCoAw&feature=share>

超伝導→突然の停電→常伝導→流れていた大電流に電気抵抗
がかかり超発熱→冷やしていた液体窒素が瞬時に蒸発→爆発



fMRI =functional MRI(機能的MRI)

- We must measure brain “activity”, not shape.
 - By using MRI, measure “blood flow”, by measuring two hemoglobins’ ratio.
 - Hemoglobin: container of oxygen.
 - Red = many oxygen.
 - Blue = few oxygen.
- Good point
 - Location is very accurately determined.
- Bad point
 - Requires a few minutes for single shot.
- Current standard for brain functional imaging.

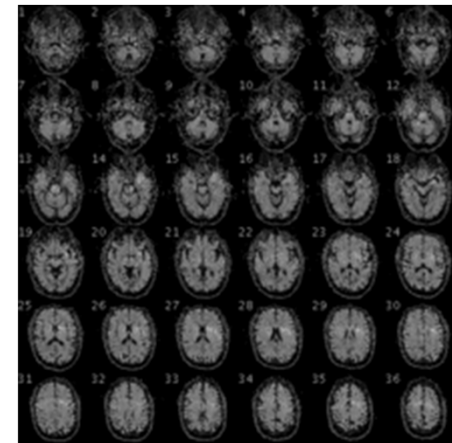
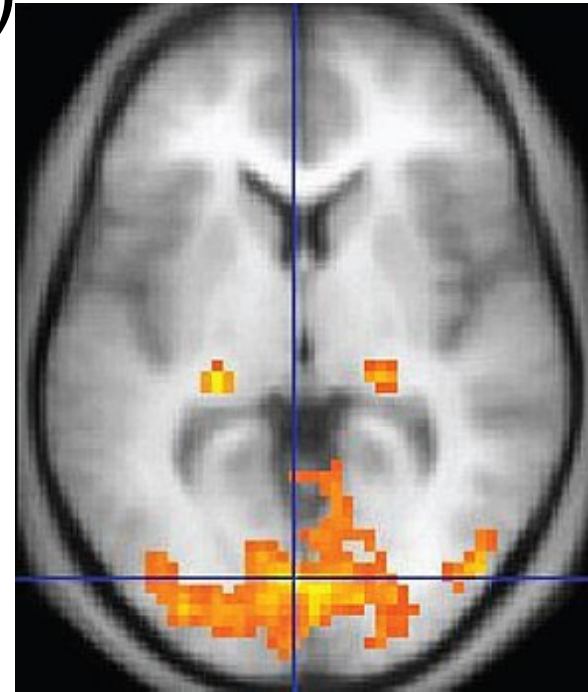

fMRI (Wikipedia)

https://en.wikipedia.org/wiki/Functional_magnetic_resonance_imaging



PET(ポジトロン断層法)

- PET = Positron Emission Tomography
 - Inject Radioactive ingredient as a “tracer” (O_{15})
 - The “tracer” collapses, and generate two “ γ waves” to the opposite direction.
 - The detector detects the phenomenon.
 - Position is determined by timing measurement.
 - Blood flow can be measured.
- Good point
 - A little faster than fMRI(a few second)
- Bad points
 - radioactive ingredient is necessary.
 - Lower resolution than MRI

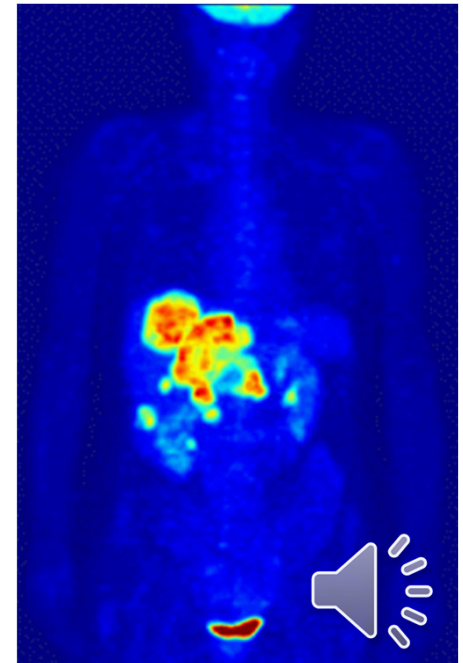
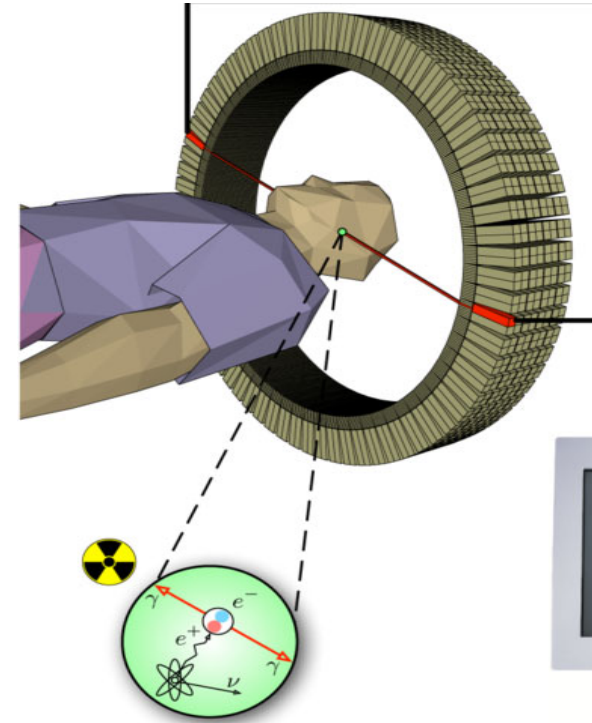

PET (Wikipedia)
https://en.wikipedia.org/wiki/Positron_emission_tomography

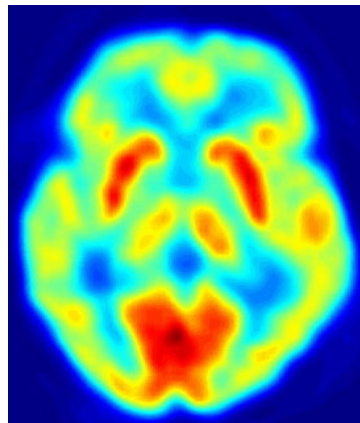

NIRS(近赤外分光法)

- NIRS=Near InfraRed Spectroscopy
 - Scull bone is transparent to InfraRed light.
 - Put InfraRed light, and obtain brain surface image.
 - Hemoglobin: container of oxygen.
 - Red = many oxygen.
 - Blue = few oxygen.
- Good points
 - No invasive. Easy to use.
- Bad points
 - Low spatial resolution
 - A few seconds are necessary

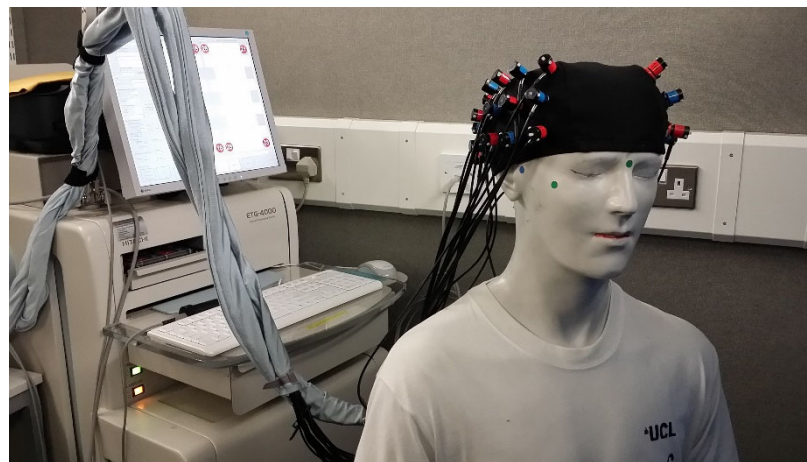

NIRS (Wikipedia)

https://en.wikipedia.org/wiki/Near-infrared_spectroscopy

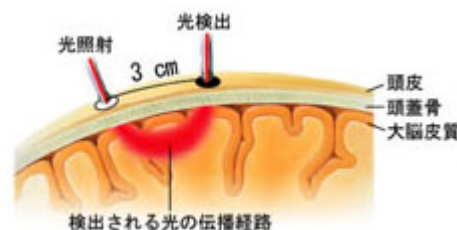

NeU

<https://neu-brains.co.jp/service/equipments/principle/>



Summary of Brain Functional Imaging

手法 Method	観察対象 Observe	空間解像度 Spatial Resolution	時間解像度 Temporal Resolution
EEG	Electric	Low	High
MEG	Electric	Low	High
fMRI	Blood	High	Low
PET	Blood	Mid	Mid
NIRS	Blood	Mid	Mid



(発展トピック)磁気パルス刺激による能動的観察 Active Measurement by Stimulation

- Recall Penfield's method.
- Transcranial magnetic stimulation (TMS)
 - Magnetic Pulse from outside
 - Small “eddy current” is induced inside the brain.
 - The current stimulates nerves
 - Region can be localized to about 1cm^3

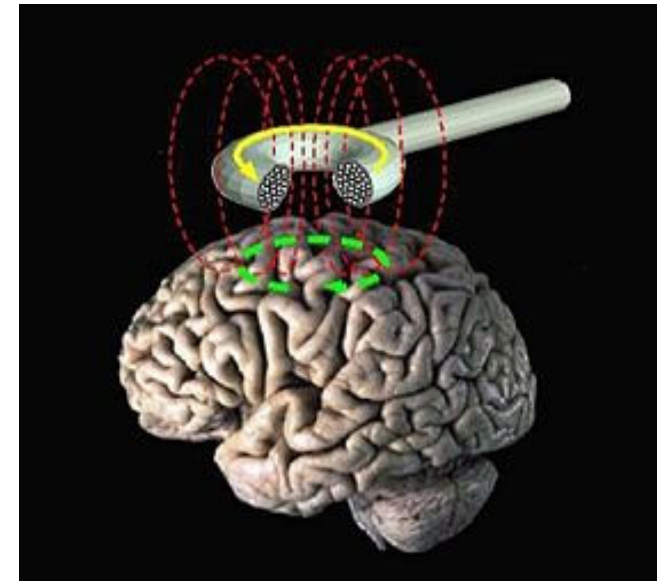

TMS (Wikipedia)

https://en.wikipedia.org/wiki/Transcranial_magnetic_stimulation



Transcranial magnetic stimulation as a therapy

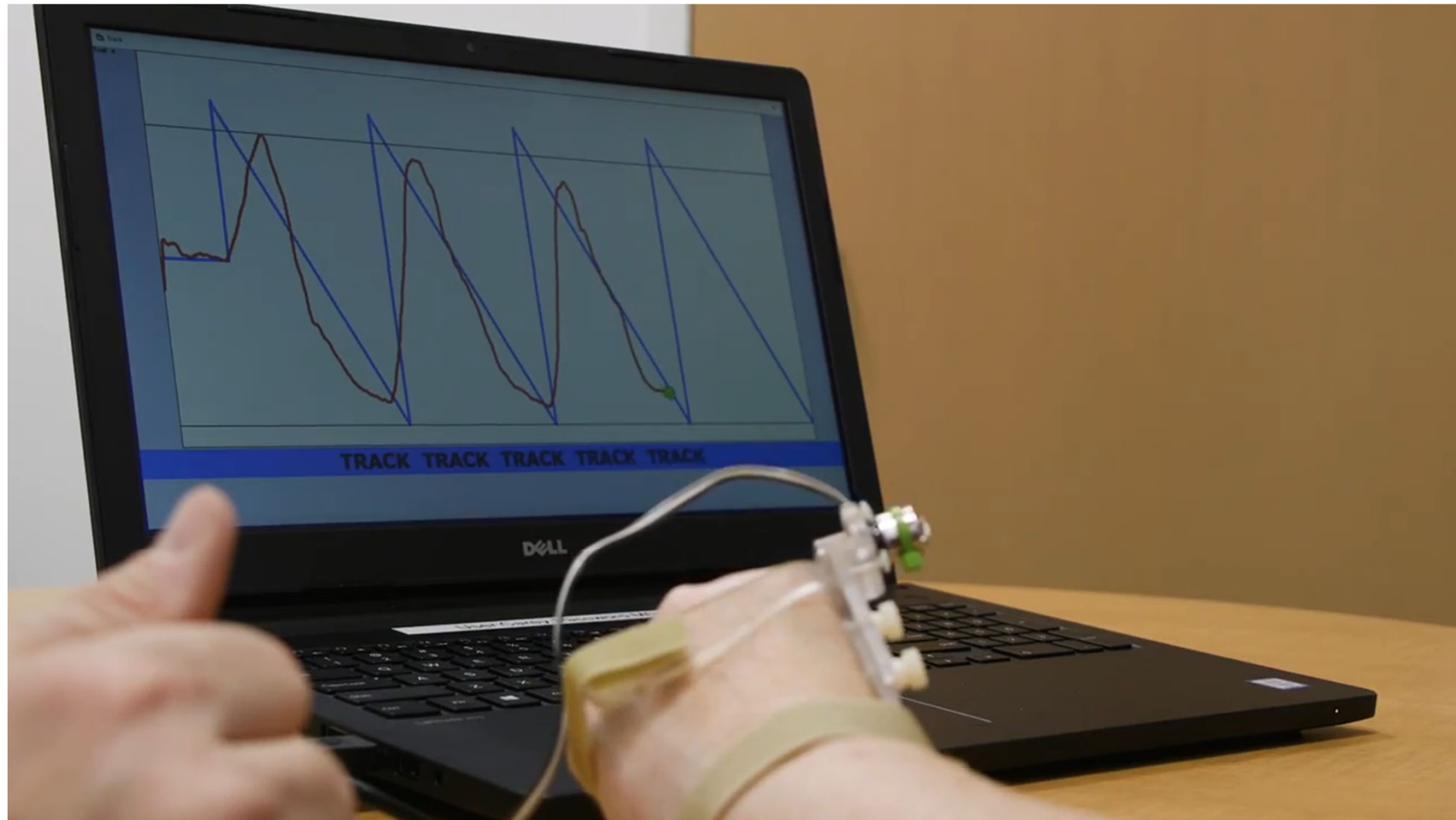

- <https://www.youtube.com/watch?v=i0GKbmbES08>
- 継続的な(repetitive)磁気刺激によるリハビリの可能性?



Brain Machine Interface (BMI)

- Growing Field
- Mainly used EEG and NIRS (Fast response is necessary)
- For welfare: for ALS(Amyotrophic Lateral Sclerosis)
 - a progressive, fatal, neuro disease caused by the degeneration of motor neurons.

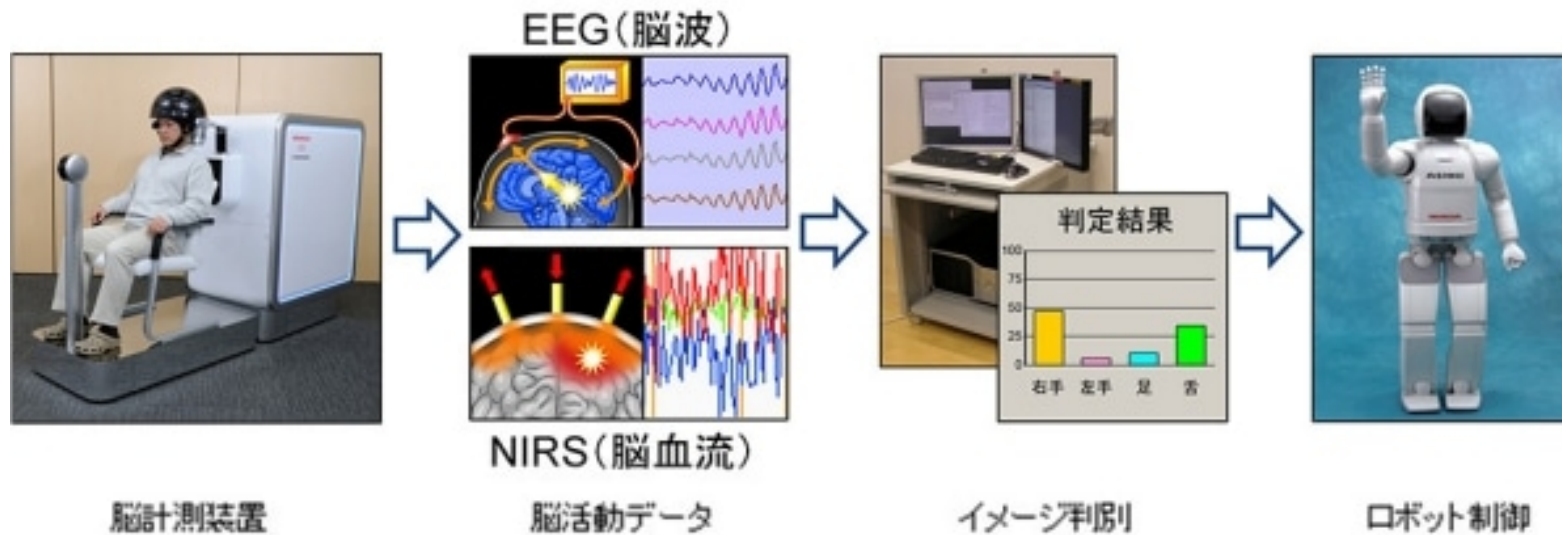

Honda、ATR、島津製作所が共同で、考えるだけでロボットを制御するBMI技術を開発 (2009)

<https://www.honda.co.jp/news/2009/c090331.html>



見たものを知る

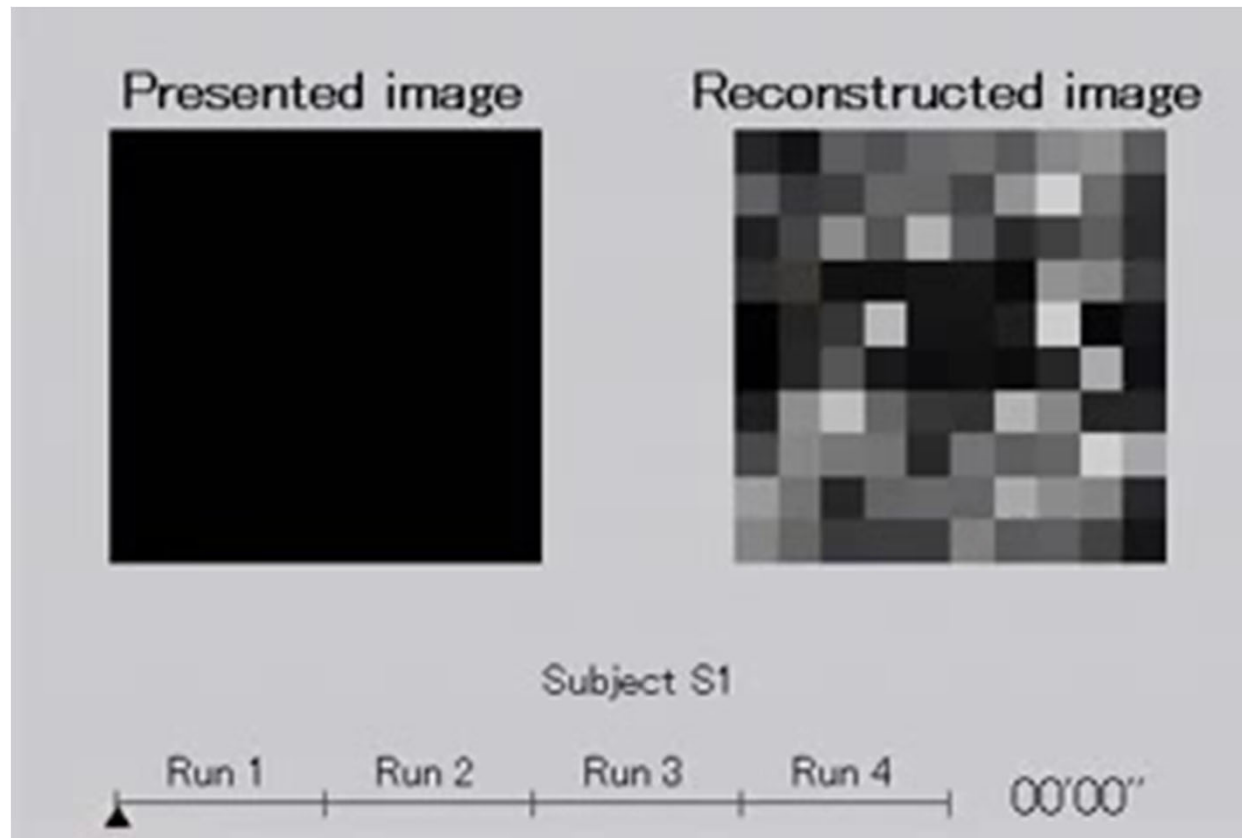

<http://www.youtube.com/watch?v=daY7uO0eftA>

脳活動パターンから見ている図形を画像として再構成する。視野を複数の解像度で小領域に分割し、それぞれの領域のコントラスト値をfMRIで計測される脳活動パターンから予測。その予測値を組み合わせることで画像全体の再構成を行う。この手法を用いることにより、脳活動パターンの学習に用いていない幾何学図形やアルファベットの形が再構成できる

Miyawaki et al., "Visual image reconstruction from human brain activity using a combination of multi-scale local image decoders"

<http://www.cns.atr.jp/dni/research/visual-image-reconstruction/>



夢を知る

脳波計(EEG)を装着した3人の被験者にfMRI装置の中で眠ってもらい、睡眠中の脳活動の計測を行い、脳波をモニタリングしながら睡眠状態の判定をリアルタイムに行い、夢見と強い関連があると知られている睡眠脳波のパターンが生じたタイミングで被験者を起こし、直前まで見ていた夢の内容を報告してもらった後、再び被験者に眠ってもらい、夢を見てもらい報告してもらう(夢報告)ということを各被験者ごとに約200回実施。

夢報告に現れる物体や風景を表す名詞などを抽出し、言語データベースを用いて解析することで、非定形な夢報告文を主要な本やクルマなど約20の物体カテゴリの有無を表現するベクトルに変換したほか、主要な物体カテゴリに対応する画像をWeb上の画像データベースから収集し、それらの画像を見た時の大脳視覚野の脳活動を使って、物体情報を解読するパターン認識アルゴリズム(デコーダ)を構築。

ATR、睡眠中に見ている夢の内容を解読する技術を開発

<http://news.livedoor.com/article/detail/7566434/>

T. Horikawa, M. Tamaki, Y. Miyawaki, Y. Kamitani, Neural Decoding of Visual Imagery During Sleep, Science, April, 2013.

<http://www.sciencemag.org/content/early/2013/04/03/science.1234330.abstract>

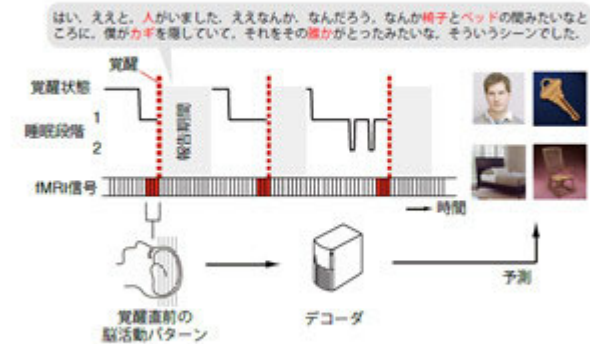

Neuralink



2021.4

<https://www.itmedia.co.jp/news/articles/2104/09/news055.html>

- 脳に”Link”チップを埋め込まれたサルが「考えただけで」PONGをプレイする。チップは外部とBluetoothで通信しており、1024本の電極が取得した情報を25msごとに外部の受信機へと脳活動データを送信。
- A monkey with a "Link" chip implanted in its brain plays PONG "just by thinking. The chip communicates via Bluetooth with the outside world, sending brain activity data acquired by 1024 electrodes to an external receiver every 25 ms.

人間計測手法／Measuring Human

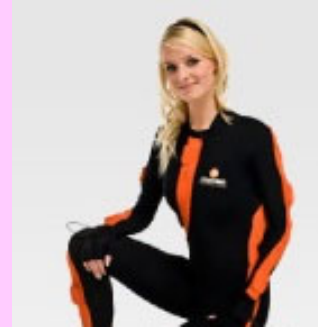

意志から行動までの「どの経路を測るか」で5つの段階
Five layers, *from our initial will to our perception.*

- 脳活動計測／Measure **brain activity**.
- 神経・筋活動計測／Measure **nerve activity**.
- 自律神経系計測／Measure **autonomic nerve** related phenomenon.
- 運動計測／Measure **motion**.
- 心理物理実験／Ask the user (**psychophysics**)



Nerve: Basics

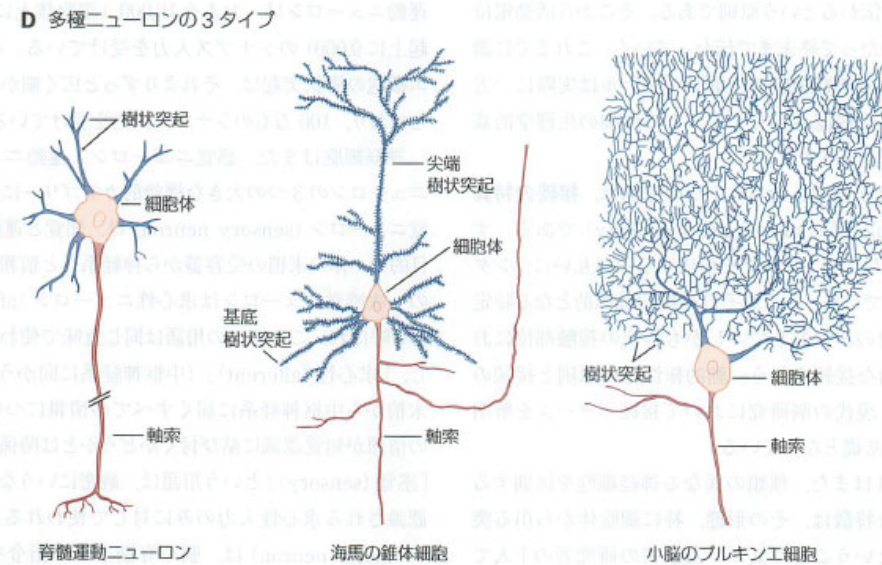
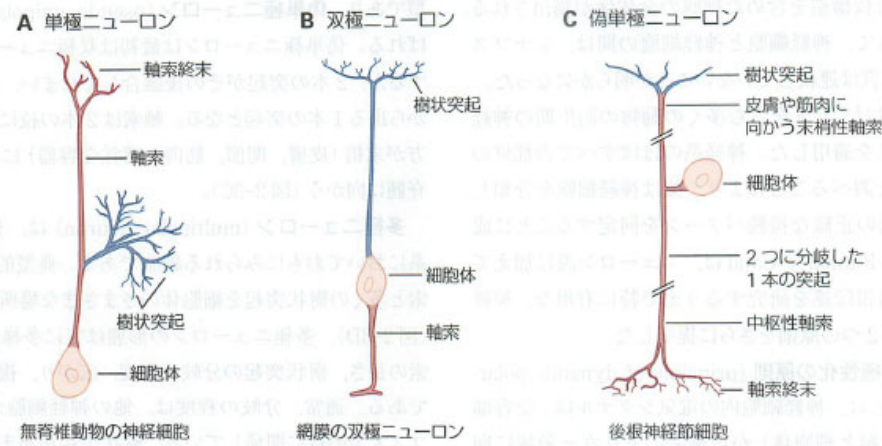
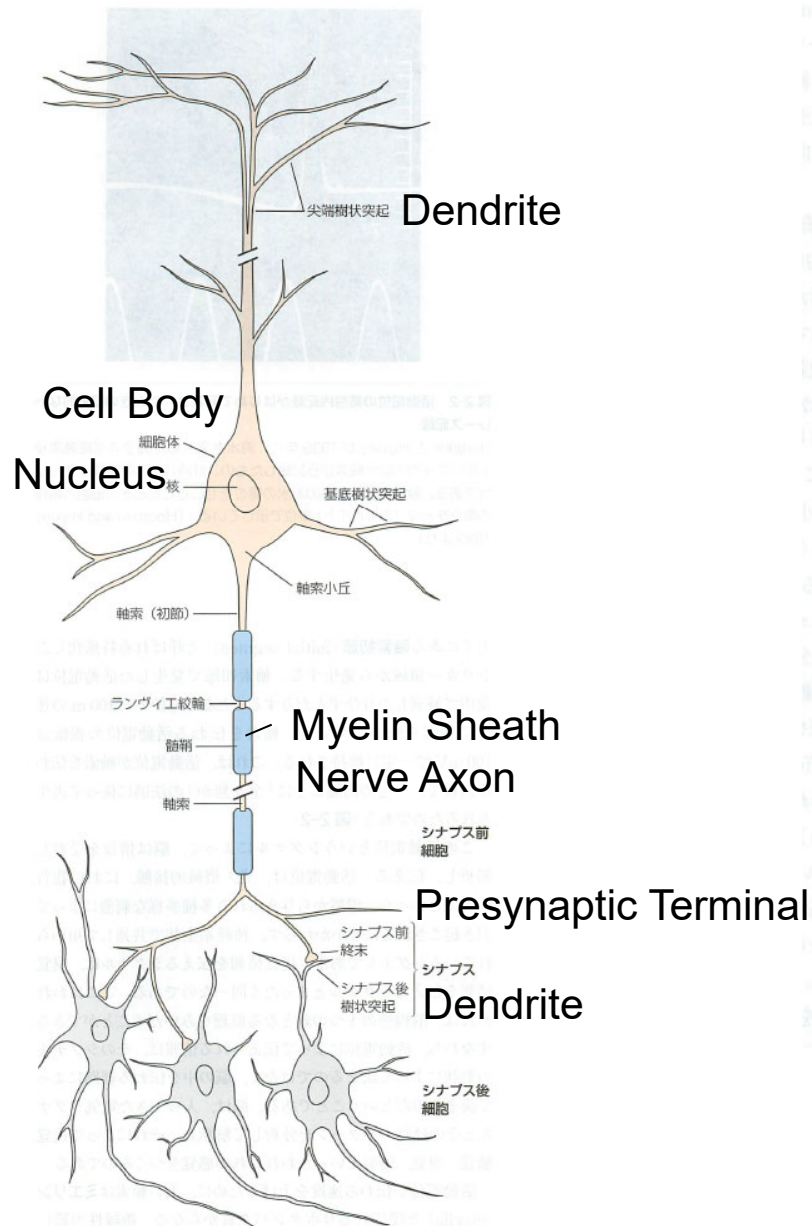

Nerve structure

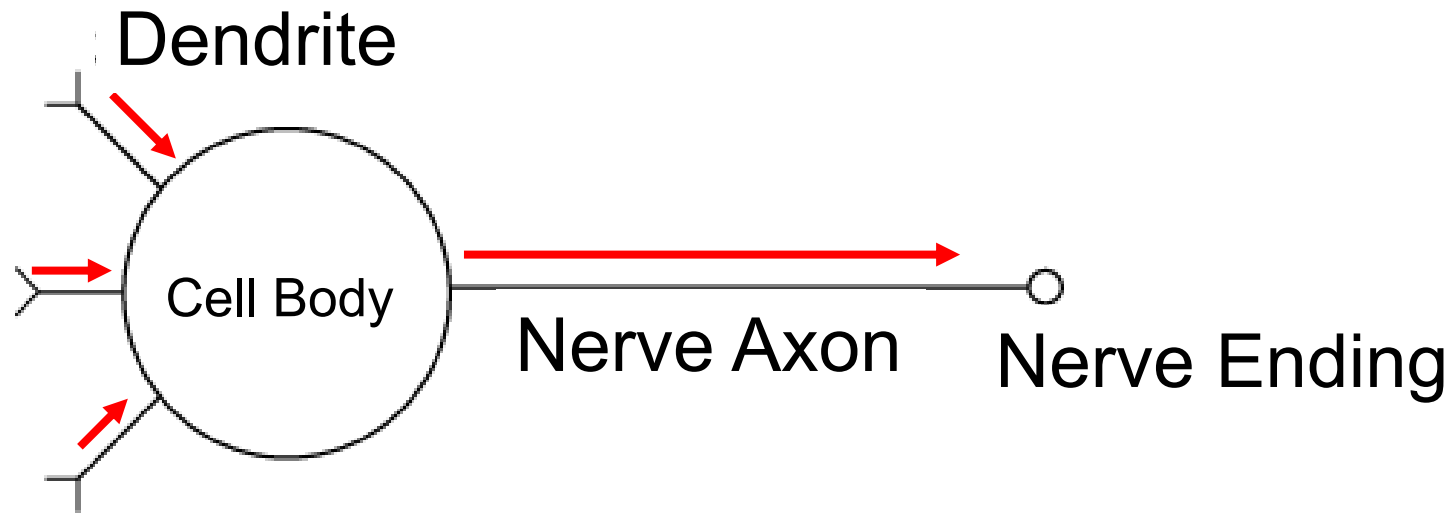

- 樹状突起 / Dendrite: Input Connector
- 細胞体 / Cell Body: Calculator (Summation)
- 軸索 / Axon: Output Cable
- 神經終末 / Nerve Ending: Output Connector



シナプス / Synapse

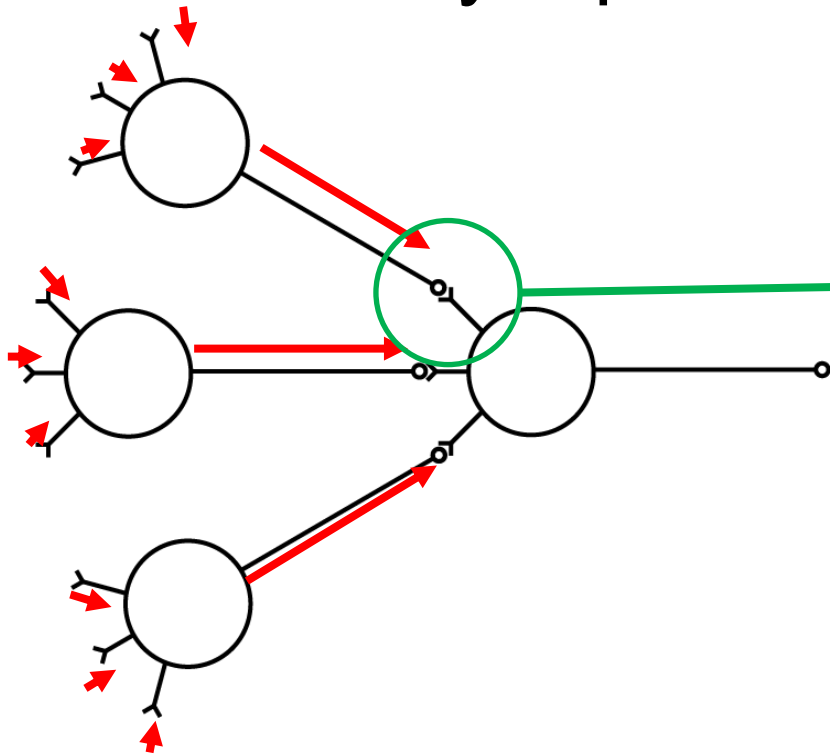

- Nerve Ending – Dendrite Connection
- 20nm “Synaptic cleft”
 - First Discovery: Electron Microscope
- 1st nerve: Electrical Pulse \Rightarrow Chemical Output
 - Capsules break, and neurotransmitter showers.
- 2nd nerve: \Rightarrow Chemical Input \Rightarrow Electrical Current
- Most are chemical synapses, but some are electrical synapses
- “One way” connection
- 0.1-0.2ms necessary

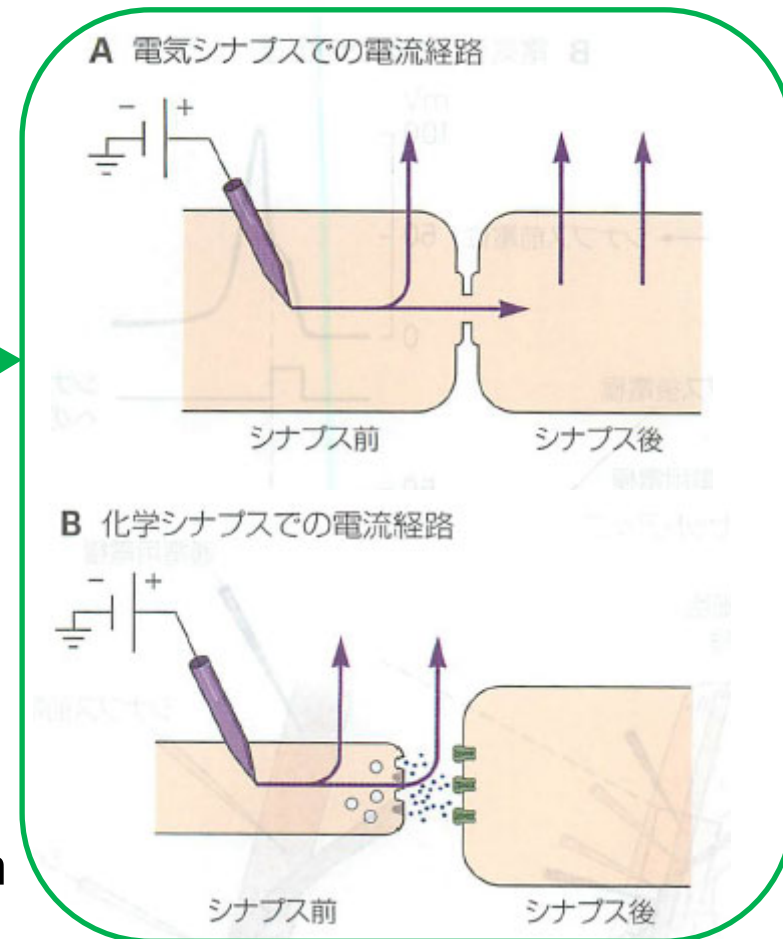

カandel神経科学(Principles of Neural Science)
<https://www.medsci.co.jp/kandel/syousai/index.html>



興奮性シナプス・抑制性シナプス

Excitatory Synapse, Inhibitory Synapse

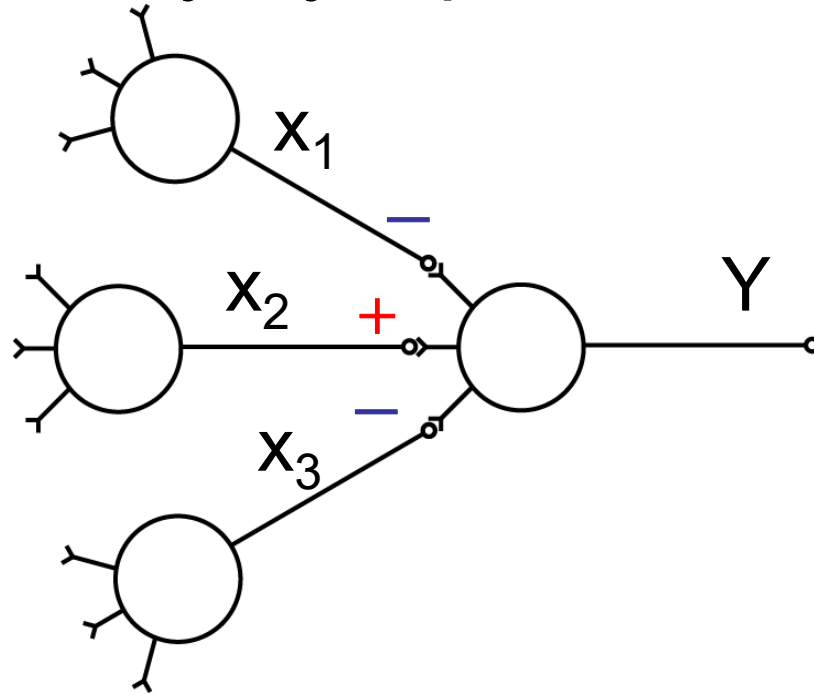

$$Y = F(X_1 - X_2 - X_3)$$

$$F(X) = 1 \quad \text{when } X \geq \text{Threshold}$$
$$= 0 \quad \text{when } X < \text{Threshold}$$

- Cell Body: Take Summation Σ
- **Excitatory Synapse: Plus(+)** input
- **Inhibitory Synapse: Minus(-)** input
- Synaptic weight change = Learning and Memory



軸索上の電位伝搬 / Axonal Transmission

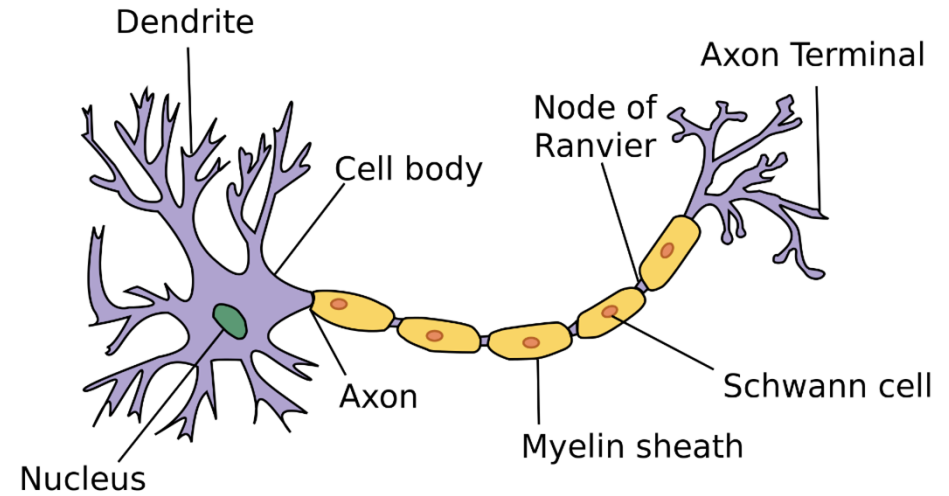
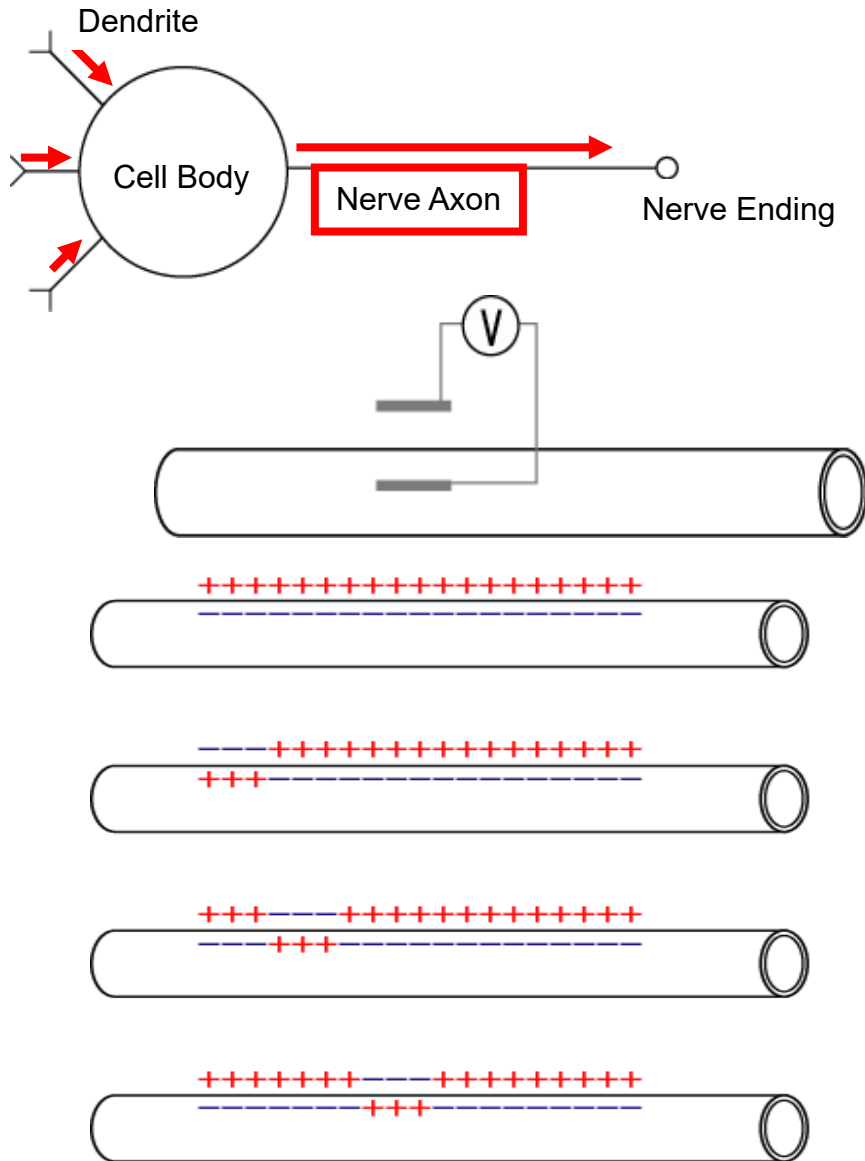

Axon (Wikipedia)
<https://en.wikipedia.org/wiki/Axon>

- Chemical “ion” is exchanged via membrane.
- Ion exchange propagates.
- Voltage Difference ~70mV



軸索のタイプ / Axon types

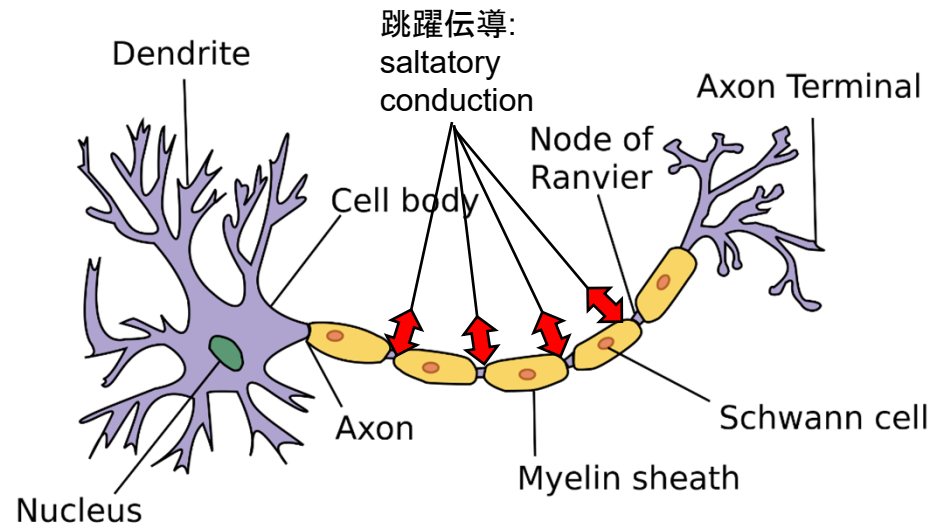
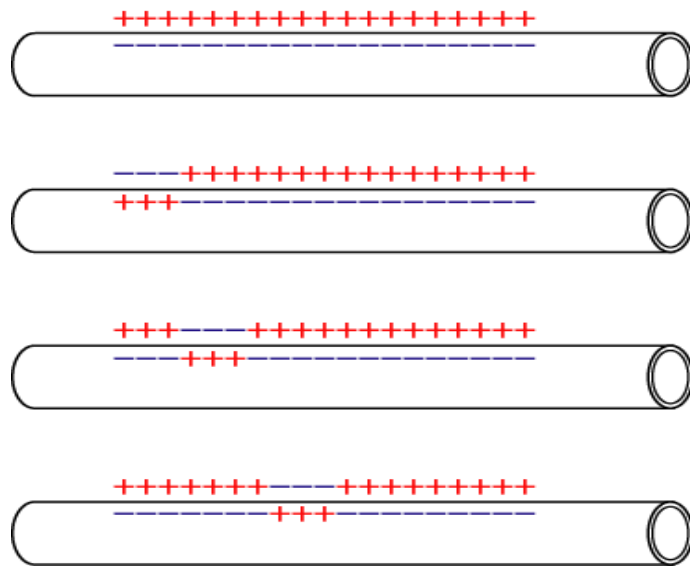

- Axon length: Reaches to 1m.
- ミエリン髓鞘 / Myelin Sheath: Insulator
 - Electrical Current is limited to very small "gap" (ランビエ絞輪 / Ranvier Node) ⇒ Very Fast "Skip"
 - (跳躍伝導: saltatory conduction)
- 有髓神経: Myelinated axon = very fast
- 無髓神経: Unmyelinated axon = very slow

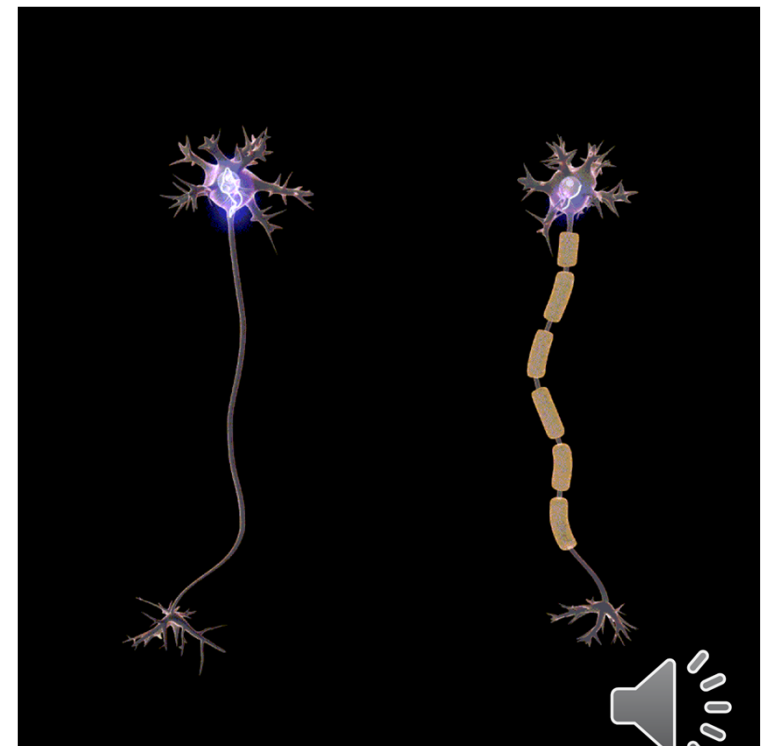

信号伝搬速度 / Conduction Velocity

	name	diameter(μm)	velocity(m/s)	role
有髄神経 Myelinated	A α	15	100	Many muscle nerves
	A β	8	50	Many sensory nerves
	A γ	5	20	Some muscle and sensory nerves
	A δ	3	15	Fast pain
無髄神経 Unmyelinated	C	0.5	1	Slow pain, heat, cold sensation, etc

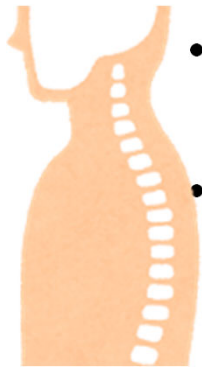

- Rule: Thicker = Faster
- Myelinated Axon: Invention of vertebrate animals (animals with back-bone).
- Other animal's strategy: Thicker the better.
 - ex) Squid's gigantic nerve (diameter: 0.5mm)



Conduction velocity and diabetes (糖尿病)

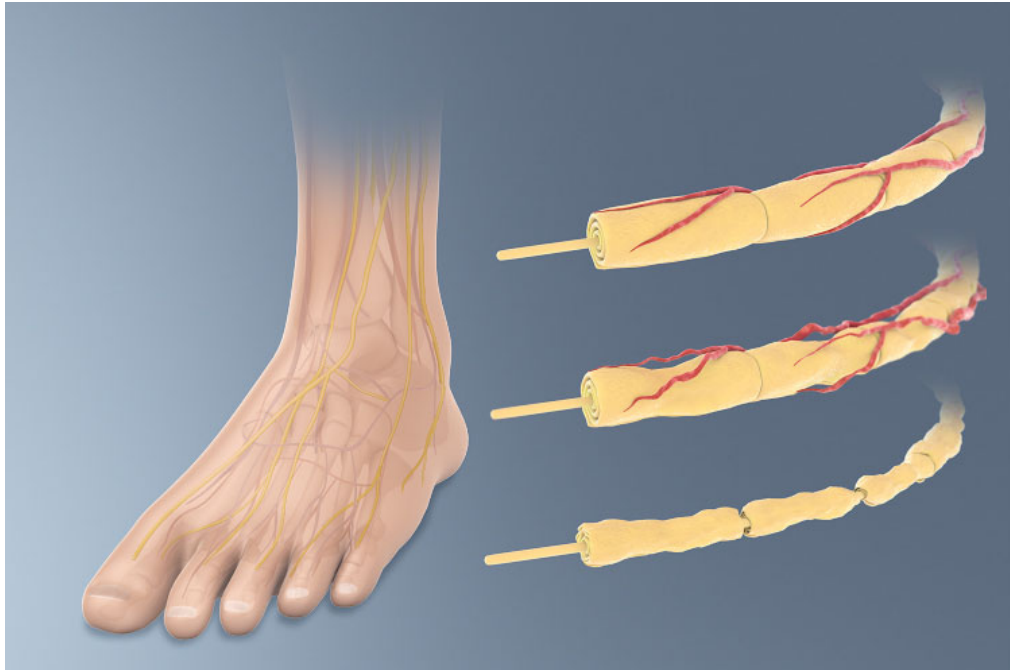

Diabetes (Wikipedia)
<https://en.wikipedia.org/wiki/Diabetes>



Nerve conduction study (Wikipedia)
https://en.wikipedia.org/wiki/Nerve_conduction_study

- Diabetic: Quite common disease by taking too much sugar.
- Damage to the nerves of the body, known as diabetic neuropathy, is the most common complication of diabetes. It damages Myelin Sheath so that nerve conduction is inhibited.
- Inspection: measure conduction velocity



Information Coding by the Nerve

- Repetition Ratio & Population

- Strong Stimulus \Rightarrow High Frequency & Large Numbers
- Single pulse means nothing.

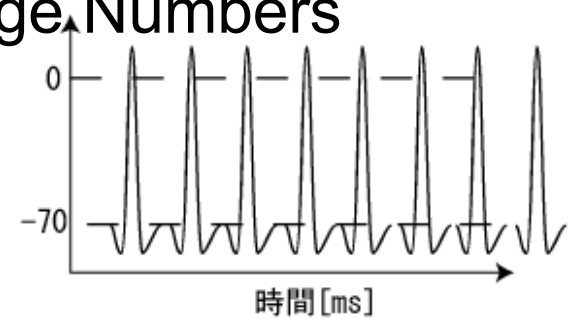
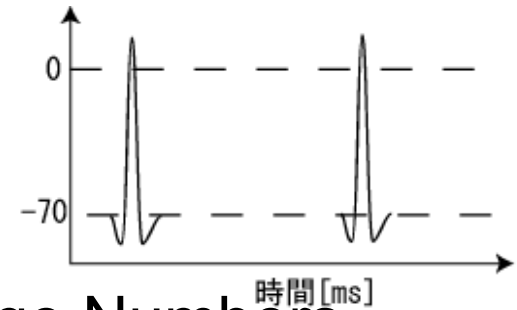

- Timing

- One nerve is activated when two inputs come simultaneously (at the same time).

(ex) Owl's Sound-Source Detection Mechanism

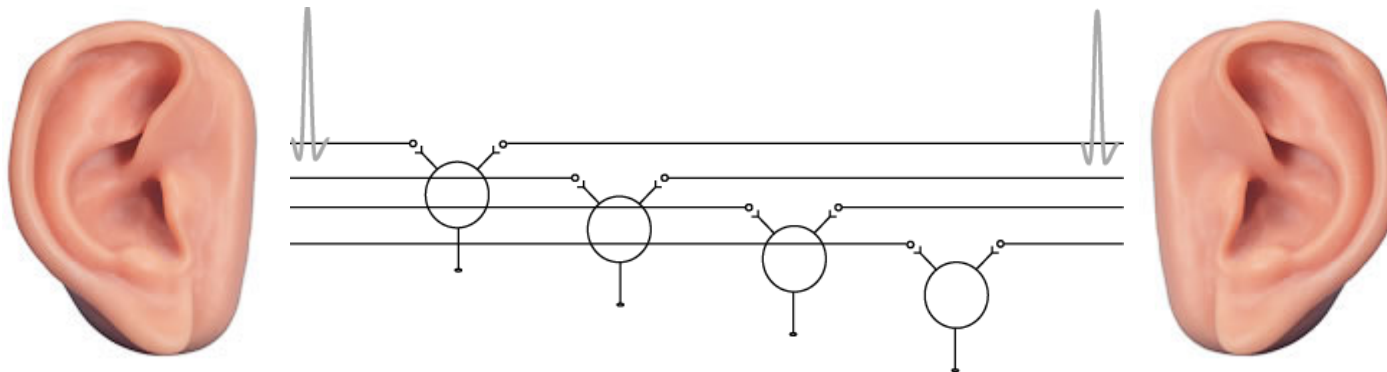

筋電計測 (electromyography - EMG)

Measurement of muscle fiber activity

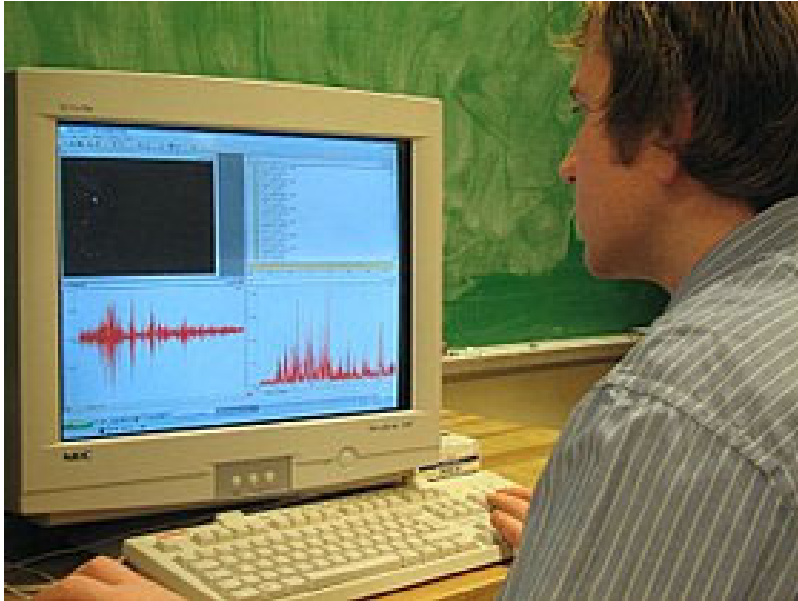

electromyography

<https://en.wikipedia.org/wiki/Electromyography>



<http://www.oisaka.co.jp/>

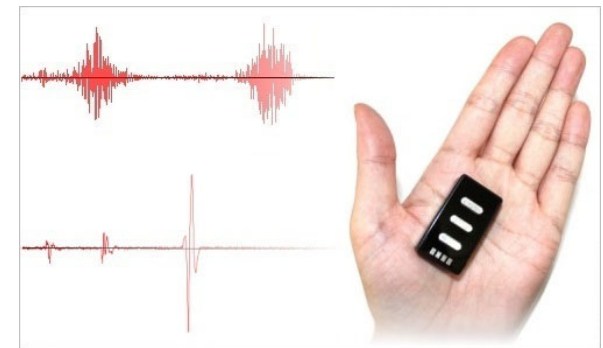

- Muscle Nerve \Rightarrow Muscle Fiber Activity
- Relatively easy with differential amplifier circuit
- Problem: Conductive Gel is required for high precision measurement.
- Frequently used for HCI



(ex) 笑いの増幅 Augmentation of Laugh

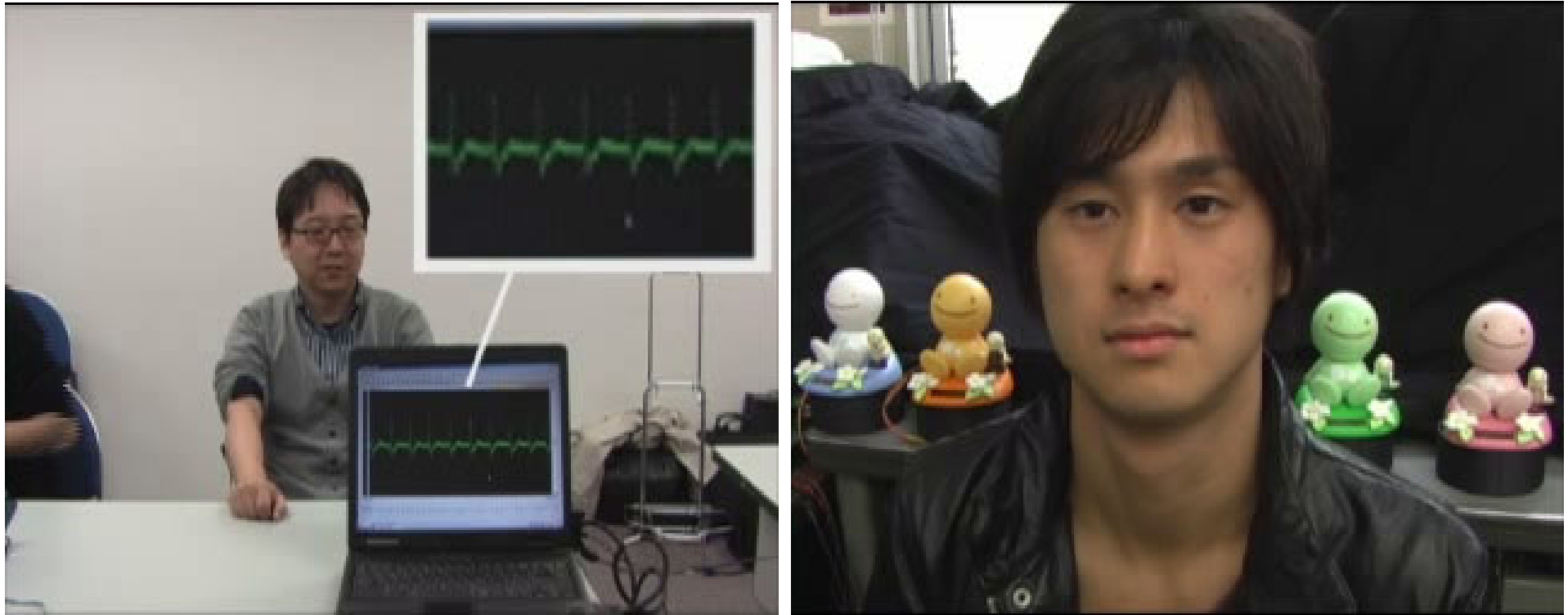

- <https://www.youtube.com/watch?v=mTsJd1O9tzs>
- Take initial laugh timing by measuring muscle activity.
- Enhance the laugh by using “empathy effect”



現状：多電極化＋機械学習によるジェスチャ認識 Trends: Multi-electrodes+Gesture Recognition

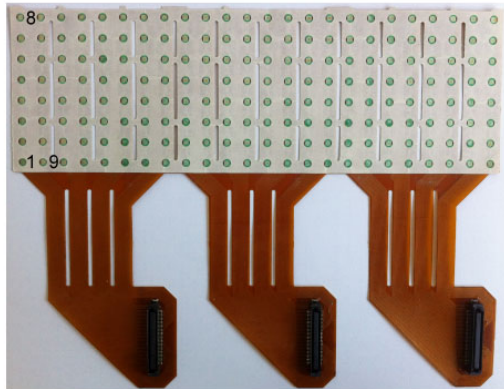
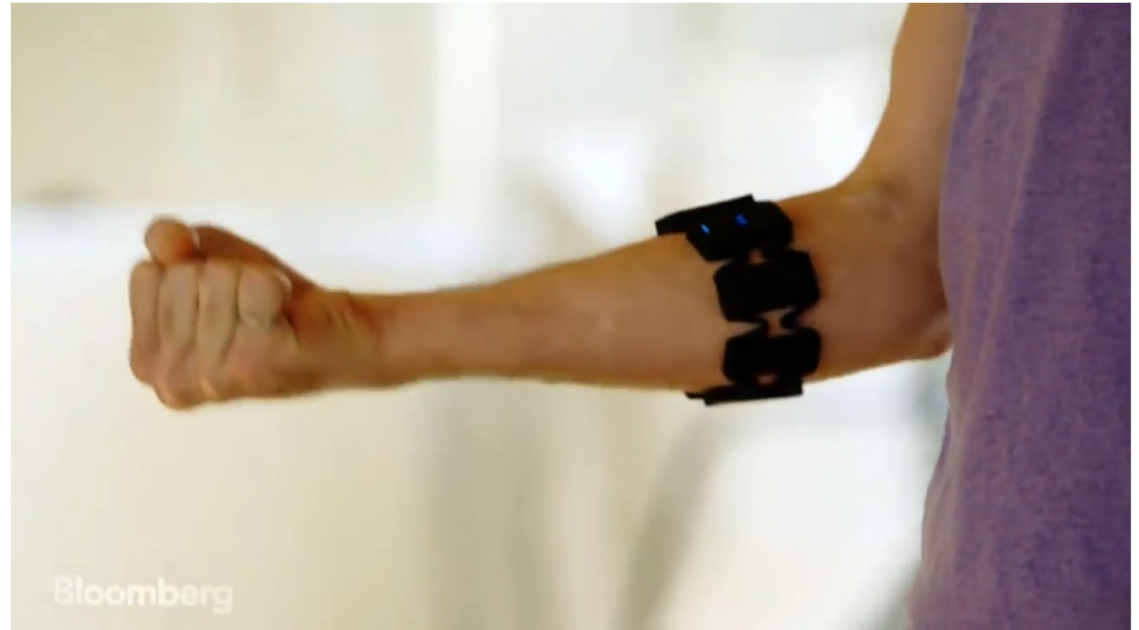

Figure 2. Picture of the electrode array used. The inter-electrode distance is 10 mm. The electrodes are arranged in a 8x24 grid. Electrode numbering starts at the lower left corner and works columnwise.



<https://www.youtube.com/watch?v=jOEcsNmTk7g>
Myo Armband

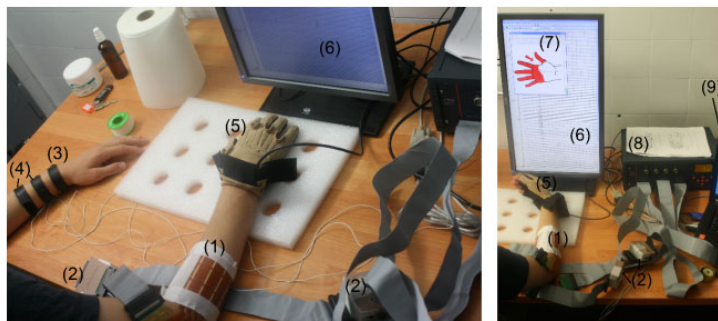

Figure 3. Picture of the actual setup used: (1) electrode array, (2) pre-amplifier, (3) Reference electrode, (4) DRL circuit, (5) data glove (not used), (6) real-time signal visualization, (7) guiding software, (8) amplifier, (9) recording computer

8x24の電極群を前腕に巻きつけジェスチャ学習

Christoph Amma et al., Advancing Muscle-Computer Interfaces with High-Density Electromyography, CHI2015



EMPress: Practical Hand Gesture Classification with Wrist-Mounted EMG and Pressure Sensing, CHI2016
Jess McIntosh, Charlie McNeill, Mike Fraser, Frederic Kerber, Markus Löchtefeld, Antonio Krüger

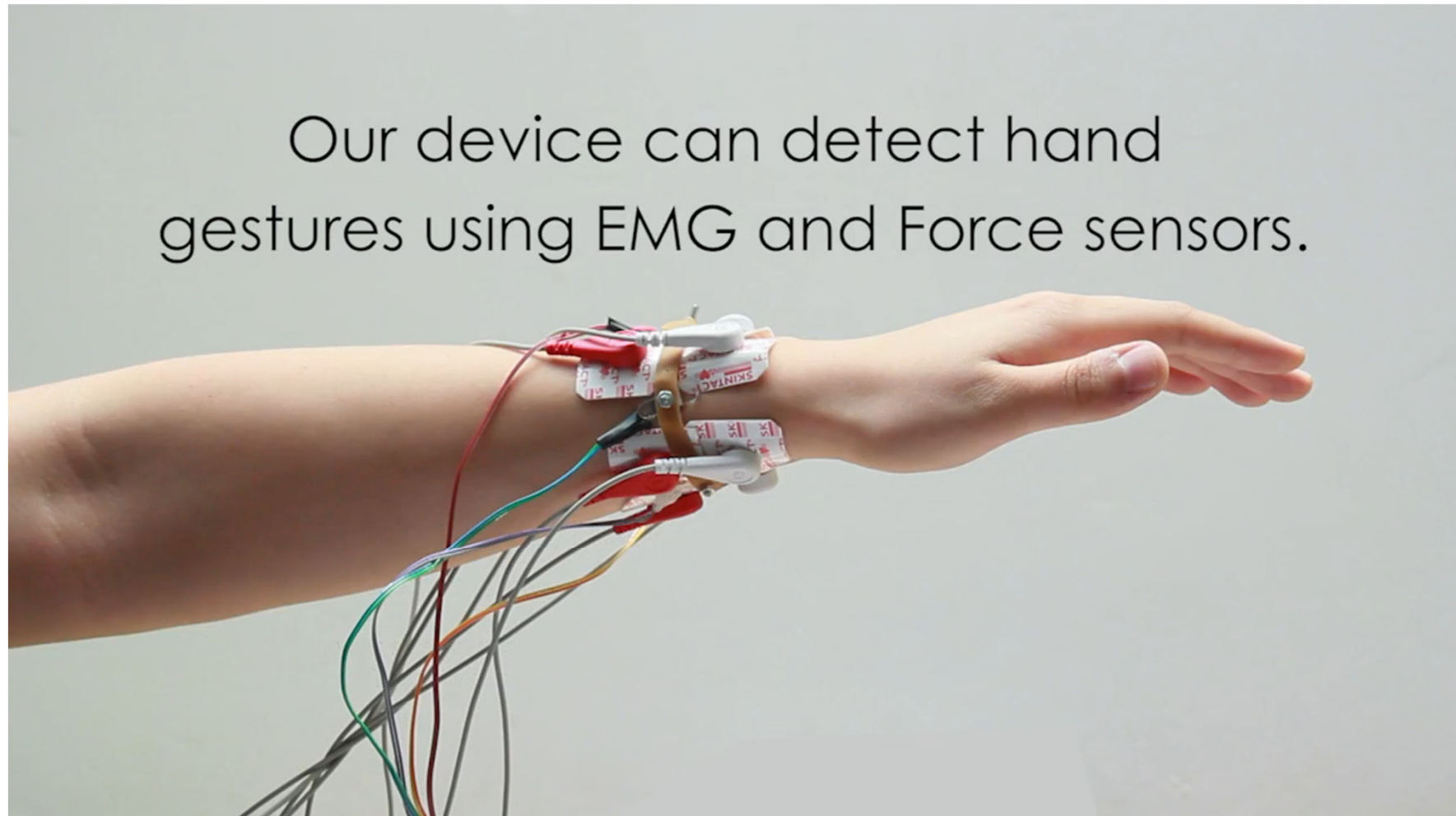

<https://www.youtube.com/watch?v=BBpHwWdR5Bc>

手のジェスチャ認識において、圧力分布と筋電分布を合わせて使うと正答率が上がる



(発展トピック)筋音計測MMG:mechanomyogram

Active Mechanomyogram Sensing Device

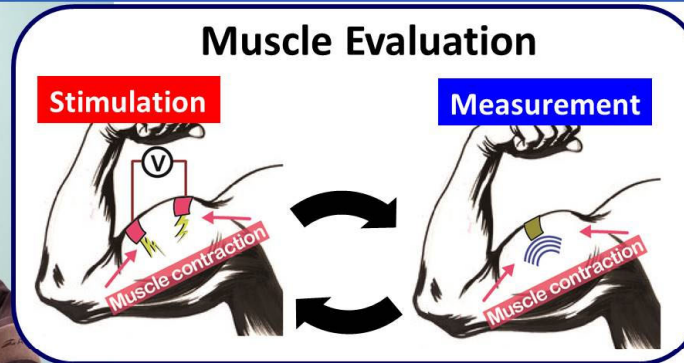

国立研究開発法人 産業技術総合研究所
センシングシステム研究センター

https://unit.aist.go.jp/ssrc/team_hysd.html

- 筋繊維の「きしみ」で音が出る現象。
- 加速度計やマイクを体表に貼付するだけで非侵襲測定
- 皮膚表面状態（汗等）に影響されない
- EMGに比べ低周波
- 原理は完全には未解明



(2019インタラクシオン) SottoVoce 超音波断層装置 を利用したサイレントな音声認識

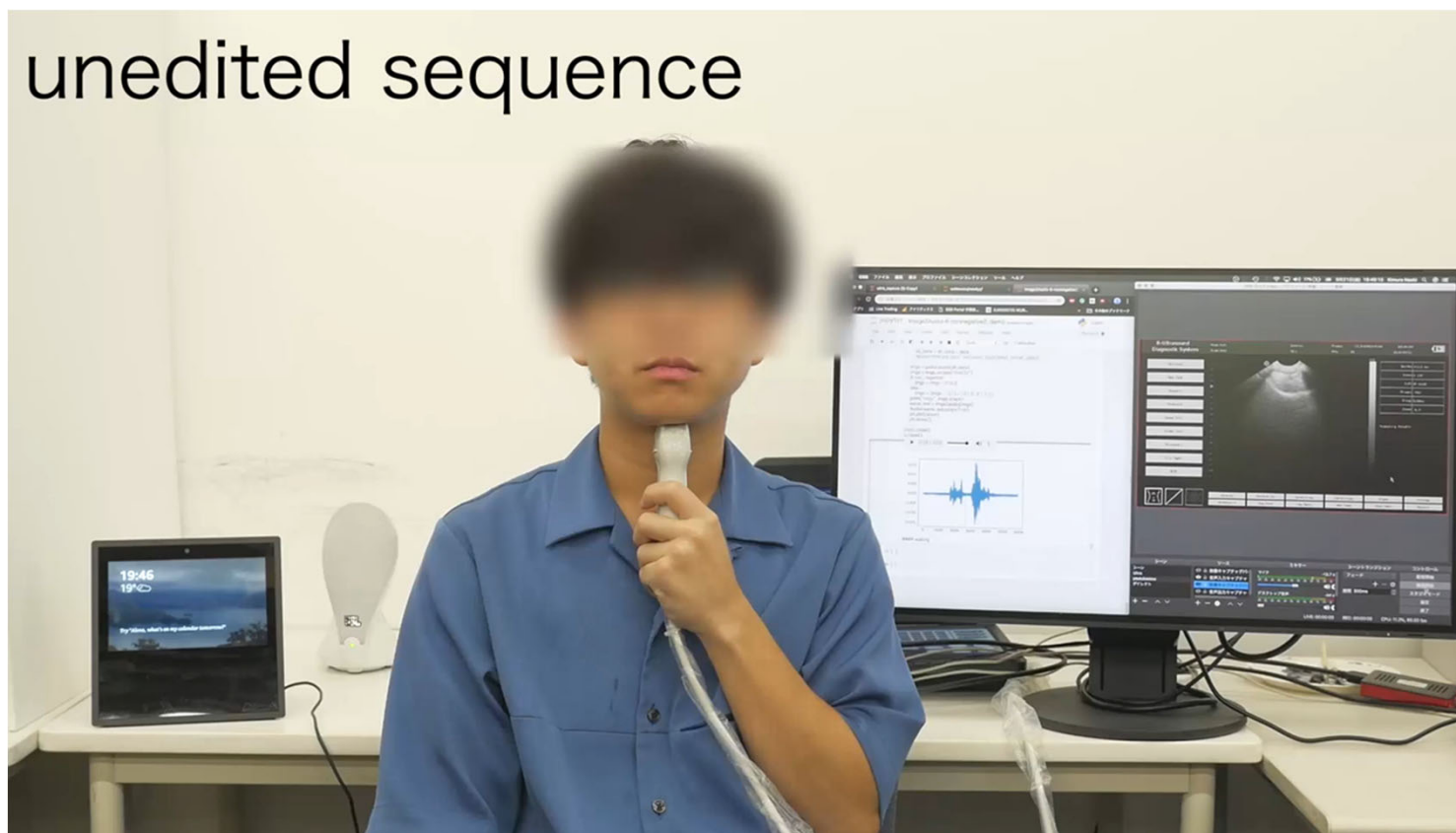

<https://www.youtube.com/watch?v=74VCUKXiT20>

<https://lab.rekimoto.org/projects/sottovoce/>

従来体内を観察（診察）するために用いられてきた超音波断層装置を、筋肉の動きをリアルタイム計測する装置として利用



人間計測手法／Measuring Human

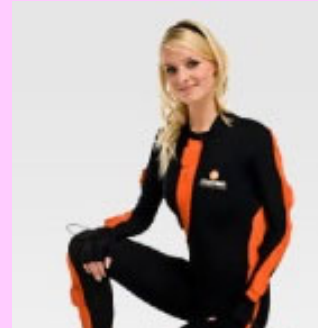
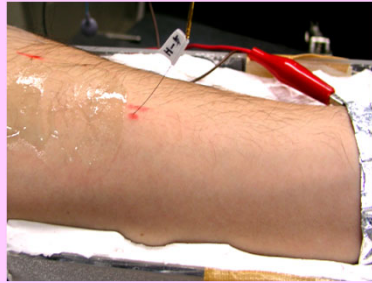

意志から行動までの「どの経路を測るか」で5つの段階
Five layers, *from* our initial will *to* our perception.

- 脳活動計測／Measure **brain activity**.
- 神経・筋活動計測／Measure **nerve activity**.
- 自律神経系計測／Measure **autonomic nerve** related phenomenon.
- 運動計測／Measure **motion**.
- 心理物理実験／Ask the user (**psychophysics**)



自律神経 / Autonomic Nervous System

Nervous system that acts as a body control system.

- Sympathetic nervous system (SNS: 交感神経)
- Parasympathetic nervous system (PSNS: 副交感神経).

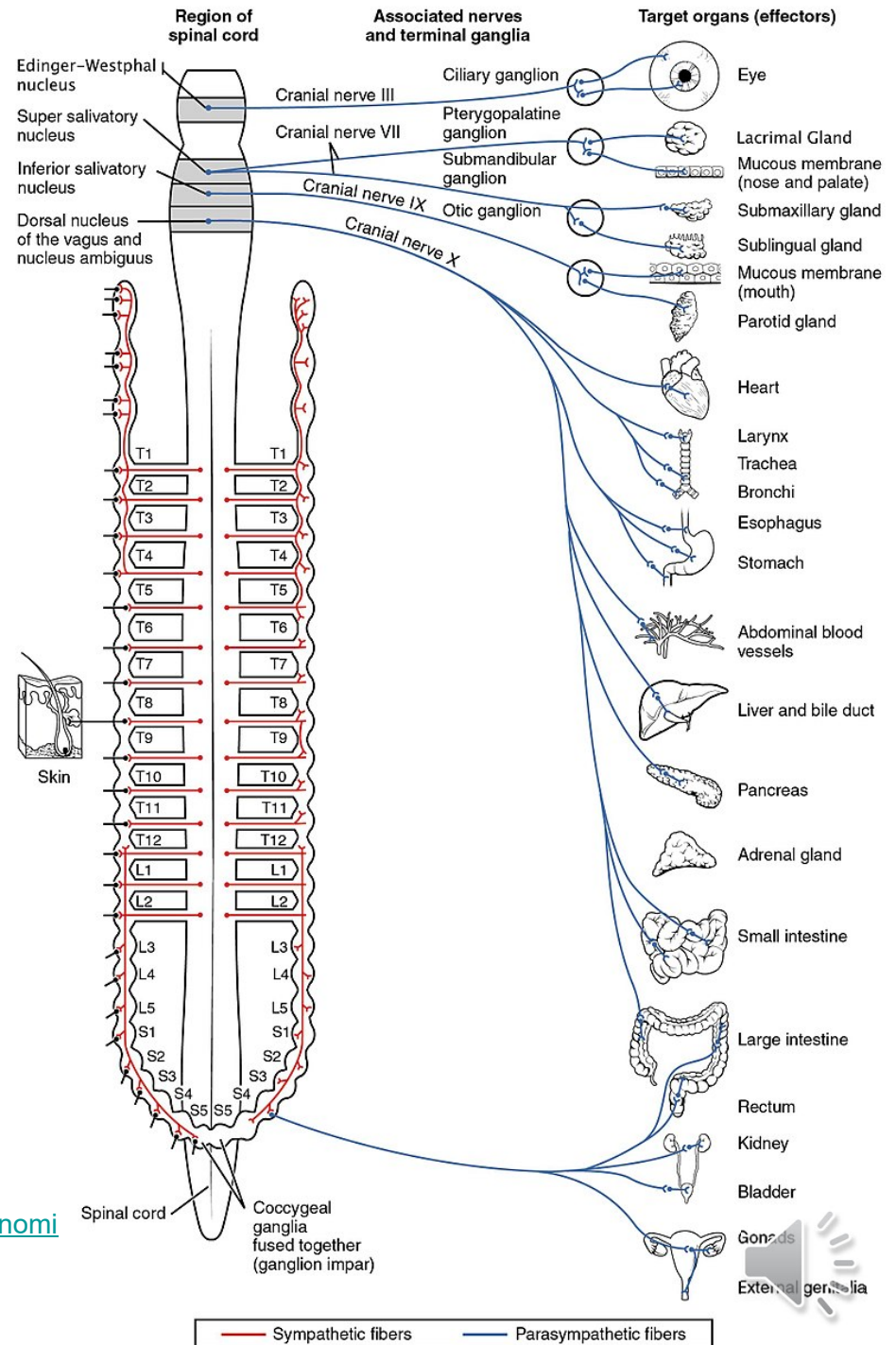

Autonomic nervous system
(Wikipedia)

https://en.wikipedia.org/wiki/Autonomic_nervous_system

Sympathetic nervous system (SNS:交感神経)



<https://en.wikipedia.org/wiki/Pupil>

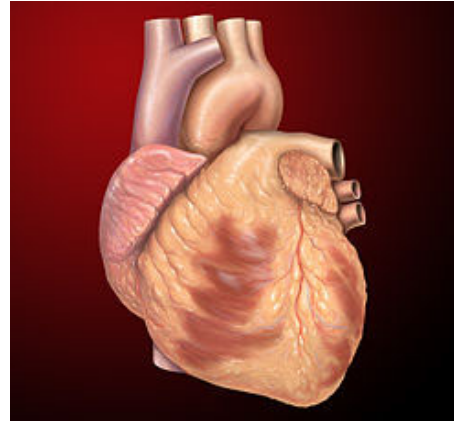

<https://en.wikipedia.org/wiki/Heart>

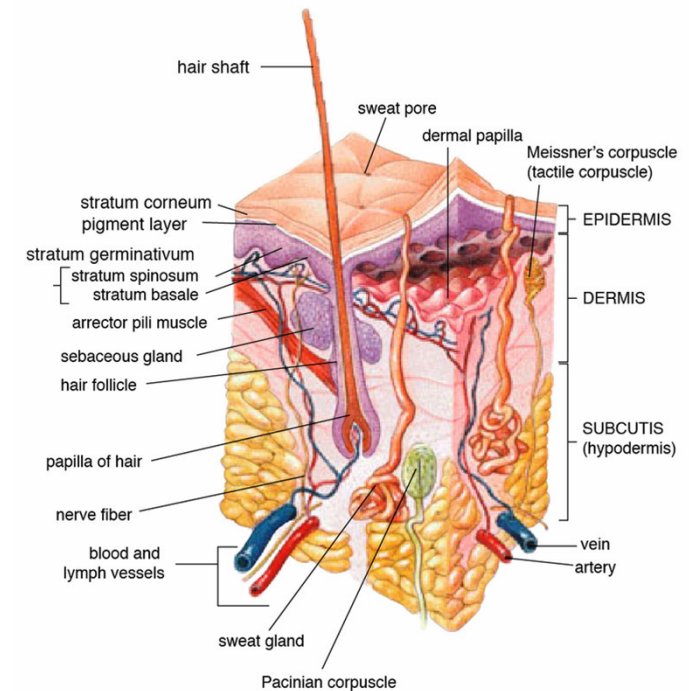

https://en.wikipedia.org/wiki/Sweat_gland

- **Nervous systems for “Fight and Flight” (闘争と逃走)**

- Eye Pupils(瞳孔) → Open
- Heart(心臓) → Blood Pressure & Beat ↑
- Skin(皮膚)
 - Sweat Gland(汗腺) → Sweat(発汗)
 - Hair Elector Muscle (立毛筋) → Contract(収縮)
- Blood Vessel(血管) → Expand 拡張 (一部収縮)



Parasympathetic nervous system (PSNS:副交感神經)



<https://en.wikipedia.org/wiki/Pupil>

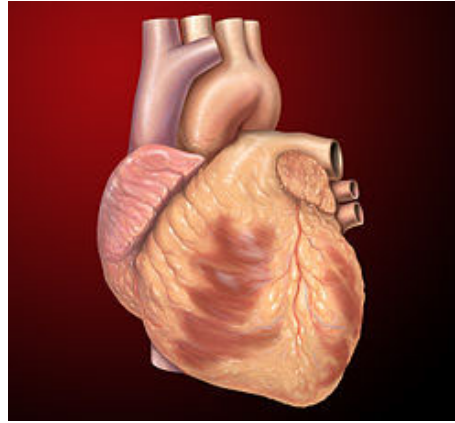

<https://en.wikipedia.org/wiki/Heart>

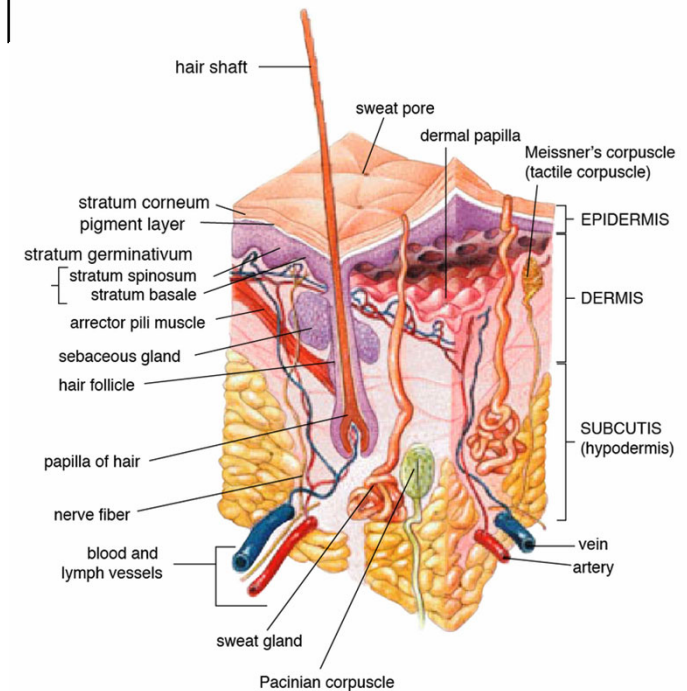

https://en.wikipedia.org/wiki/Sweat_gland

- **Nervous systems for “calming” (沈靜)**
 - Eye Pupils (瞳孔) → Close
 - Heart (心臟) → Blood Pressure & Beat ↓
 - Blood Vessel (血管) → Contract 收縮 (一部擴張)



情動を測定／Measure Emotional State

- Heartbeat & Blood Pressure (心拍数、血圧)
- Pulse Wave (脈波)
- GSR(galvanic skin response, 皮膚電気反応)
- Eye movement (眼球運動)

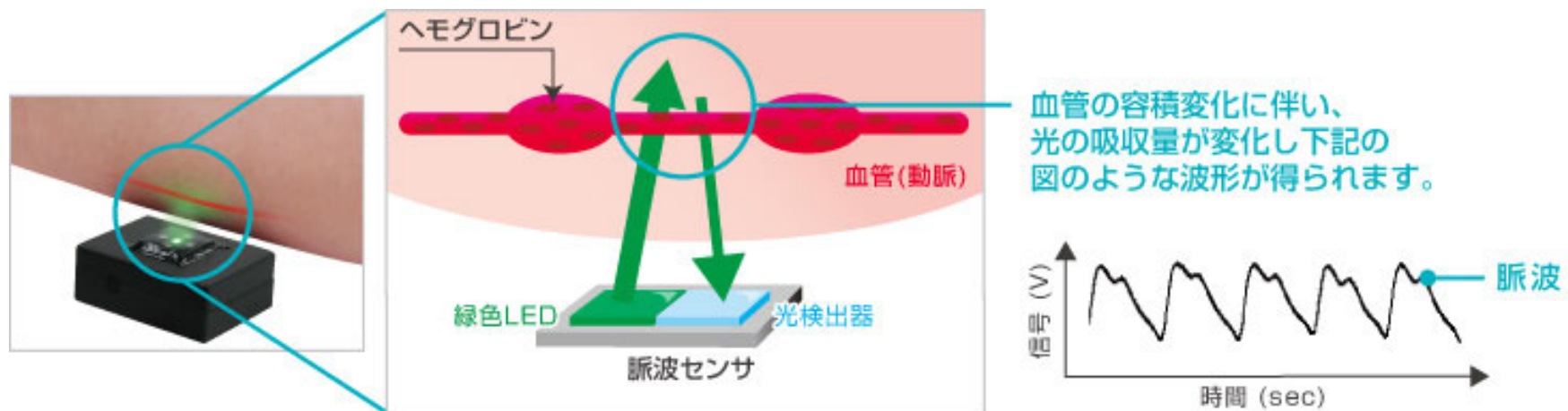

ローム 脈波センサの開発

<https://www.rohm.co.jp/pulse-wave-sensor>



Seismo: Blood Pressure Monitoring using Built-in Smartphone Accelerometer and Camera (CHI2018)
Edward Jay Wang, Junyi Zhu, Mohit Jain, Tien-jui Lee, Elliot Saba, Lama Nachman, Shwetak N Patel

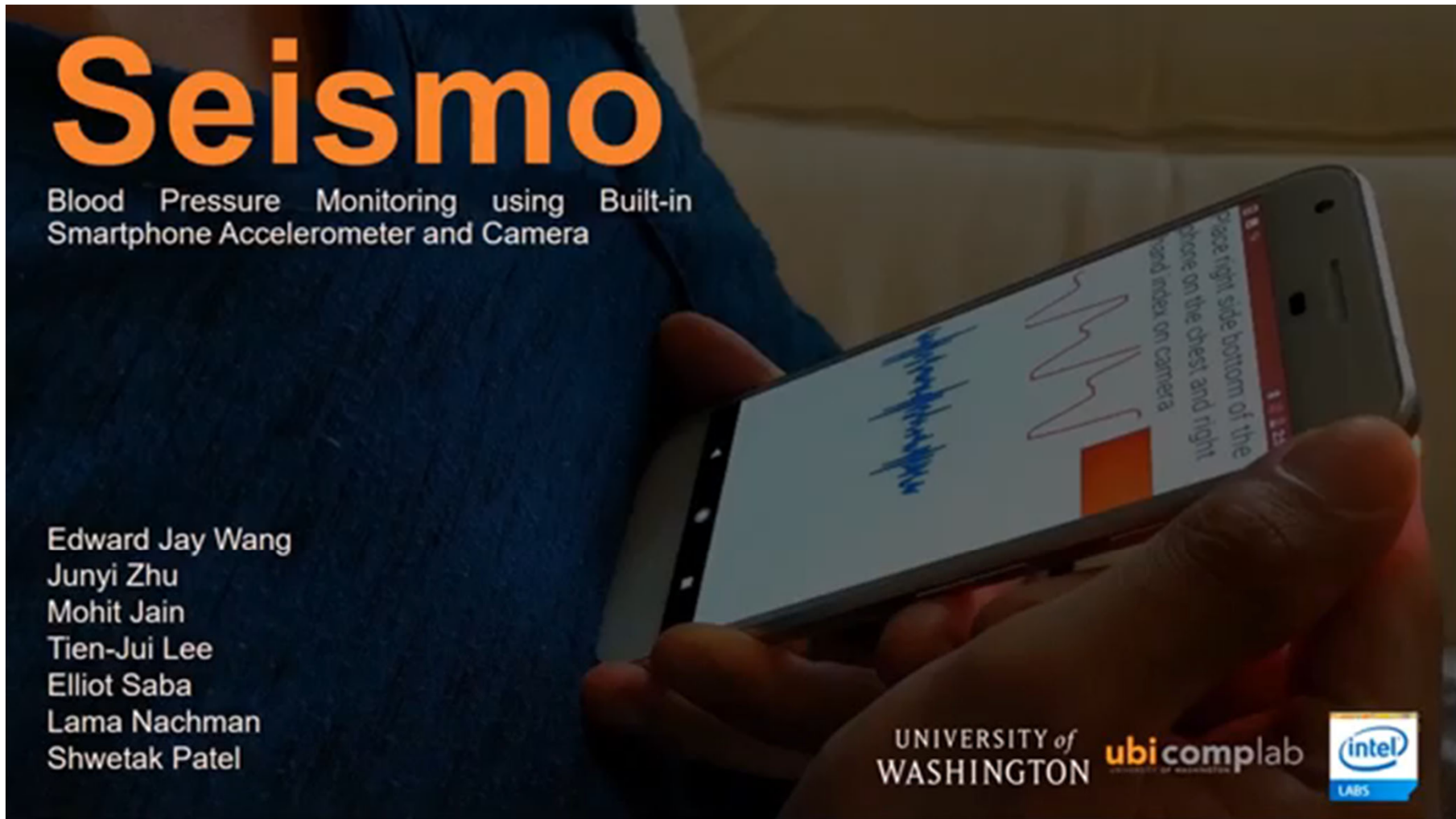

Seismo
Blood Pressure Monitoring using Built-in Smartphone Accelerometer and Camera

Edward Jay Wang
Junyi Zhu
Mohit Jain
Tien-Jui Lee
Elliot Saba
Lama Nachman
Shwetak Patel

UNIVERSITY of WASHINGTON **ubi**complab 

Place right side bottom of the phone on the chest and right hand index on camera

<https://www.youtube.com/watch?v=Xd6hSQYHVCc>

- スマートフォンを胸に押し当てた状態で計測。加速度センサで心拍が計測でき、カメラへの指の押し当てで指先の血流変化が計測できる。結果として心拍から指先の脈動にかかる時間が分かるので、血圧を推定できる。

皮膚コンダクタンス反応のインタラクティブシステムへの応用

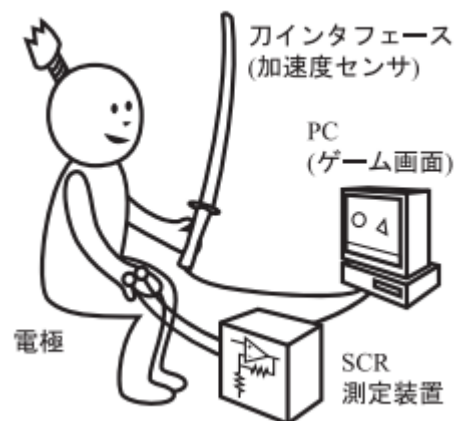

棟方他「ポジティブ・バイオフィードバックを利用したインタラクティブゲーム」コンピュータソフトウェア, vol.27, No.2 (2010)

https://www.jstage.jst.go.jp/article/jssst/27/2/27_2_2_62/_pdf

皮膚コンダクタンス反応を利用して、「焦れば焦るほど不利になる」ゲーム演出を実現。

<https://www.youtube.com/watch?v=m5GSSbSabGI>

Fukushima et al., Facilitating a Surprised Feeling by Artificial Control of Piloerection on the Forearm, AugmentedHuman 2012

皮膚への刺激による情動提示。
評価指標として皮膚コンダクタンス反応を利用



(CHI2021) Teardrop Glasses: Pseudo Tears Induce Sadness in You and Those Around You, Shigeo Yoshida, Takuji Narumi, Tomohiro Tanikawa, Hideaki Kuzuoka, Michitaka Hirose



https://www.youtube.com/watch?v=yCkBQ_eBfJo&list=PLqhXYFYmZ-Vdsg4-okDWnptnyAs8HXjfN&index=235

- 疑似涙⇒悲しみの誘発。
- Pseudo tears => induction of sadness.

人間計測手法／Measuring Human

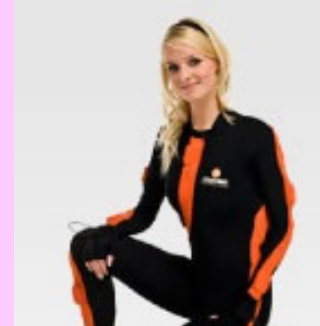
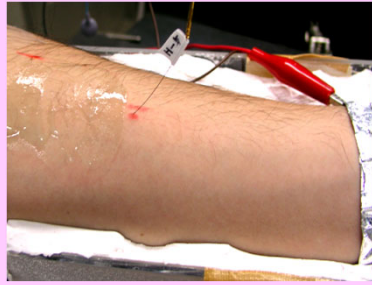

意志から行動までの「どの経路を測るか」で5つの段階
Five layers, *from our initial will to our perception.*

- 脳活動計測／Measure **brain activity**.
- 神経・筋活動計測／Measure **nerve activity**.
- 自律神経系計測／ Measure **autonomic nerve** related phenomenon.
- 運動計測／Measure **motion**.
- 心理物理実験／Ask the user (**psychophysics**)



行動計測／Measuring Motion

- Motion Capture System
 - 光学式／Optical
 - 機械式／Mechanical
 - 磁気式／Magnetic
 - ビデオ式／Image Processing*
- 一長一短／Pros and Cons
 - 遮蔽問題／Occlusion
 - ワークスペース／Workspace
 - 金属の影響／Effect of Metal

*KINECT等の詳細は後の回で

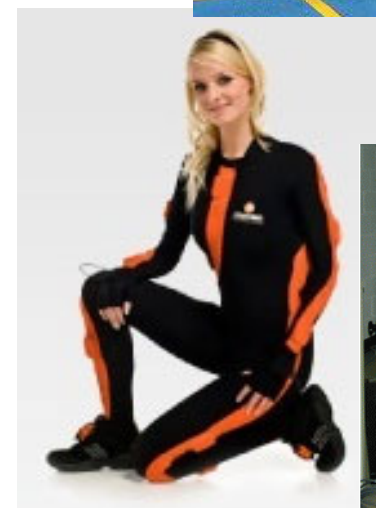

Becomes simpler and ubiquitous

- Gaming controllers can be used as a measuring device.
 - 重心動揺計測⇒Wii Balance Board
 - 運動計測⇒Wii Remote
 - 全身運動など: KINECT, Leap Motionなどの台頭
- モジュールの入手性が非常に高くなっている
 - 加速度センサ、ジャイロセンサからGPSまで
- Smartphone, Smartwatchを利用すれば安価にセンシング & 高度な処理が可能

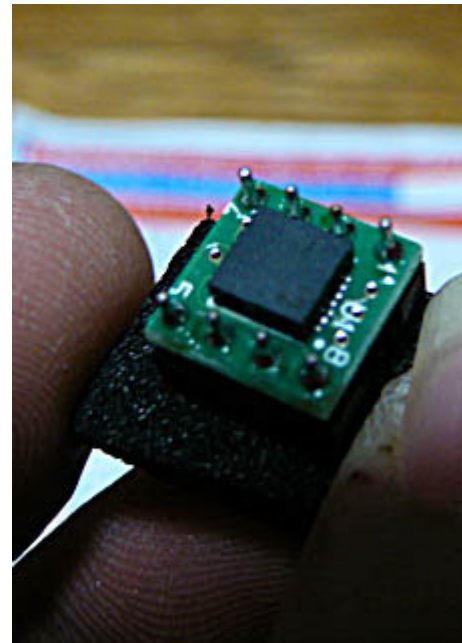

Example of using smartwatch as a sensing module
(CHI2020) WATouCH: Enabling Direct Input on Non-touchscreen Using Smartwatch's
Photoplethysmogram and IMU Sensor Fusion
Hui-Shyong Yeo;Wenxin Feng;Michael Xuelin Huang

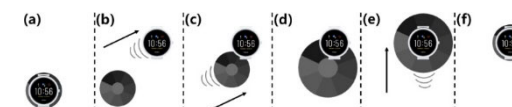
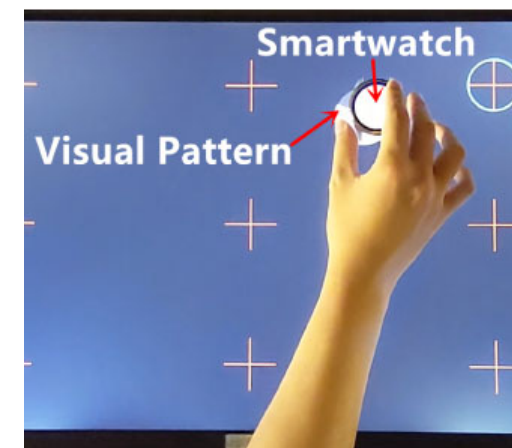
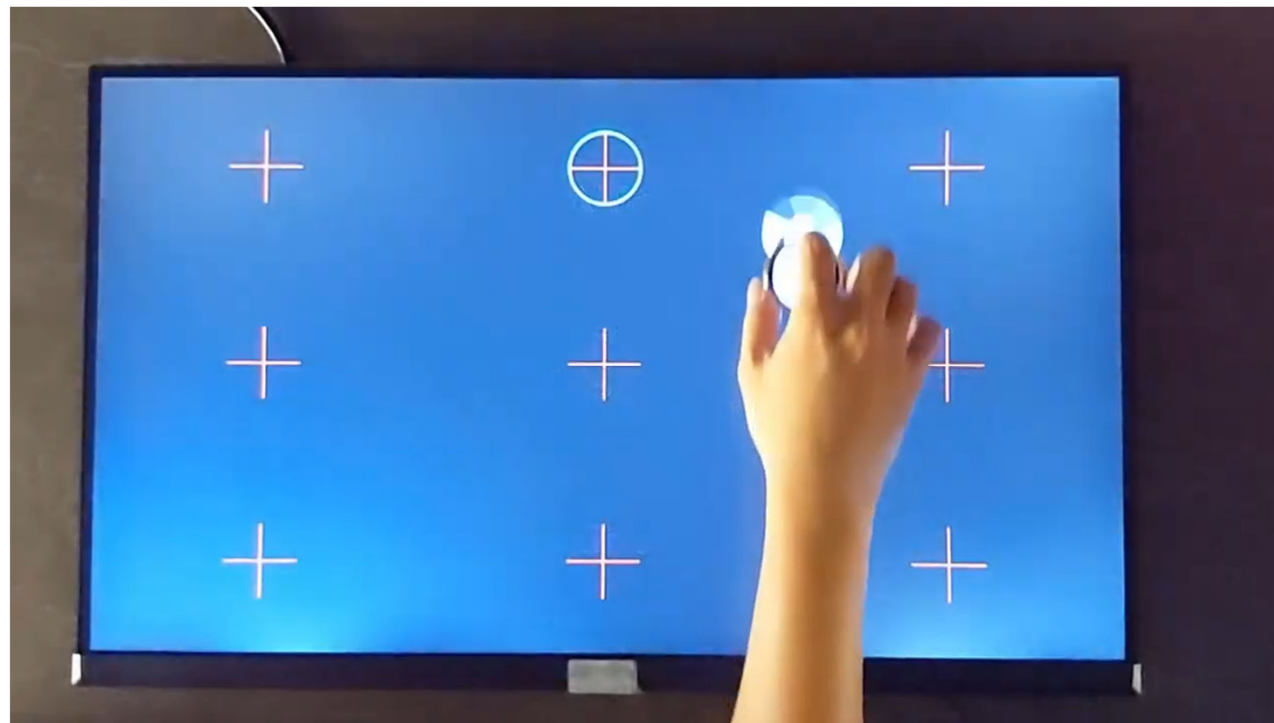

- <https://www.youtube.com/watch?v=6OxQ84jryUU>
- スマートウォッチ内蔵のIMU(慣性航法位置センシング)と、パルスオキシメータ(光センサ)を使ったディスプレイ画面上の位置トラッキング。IMUだけだとずれていくのを、画面上のパターンとパルスオキシメータの利用で補償する。
- 稲見研のDisplay-Based Trackingの発想に近い。スマートウォッチを手軽なセンシング部品として利用。



Body motion estimation by facing camera

(CHI2021) Pose-on-the-Go: Approximating User Pose with Smartphone Sensor Fusion and Inverse Kinematics
Karan Ahuja, Sven Mayer, Mayank Goel, Chris Harrison



https://www.youtube.com/watch?v=Y6_9CL5gWB8&list=PLqhXYFYmZ-Vdsg4-okDWnptnyAs8HXjfN&index=131

- 手に持ったスマートフォンだけで、人の全身の動きをある程度推測する。前後カメラ、Depthカメラ、タッチスクリーン、9軸センサ、身体のカネマティクスを利用。
- It predicts movement of a person's entire body using only a smartphone held in the hand. Utilizes front and rear cameras, Depth camera, touch screen, 9-axis sensors, and body kinematics.

(CHI2022) ControllerPose: Inside-Out Body Capture with VR Controller Cameras
Karan Ahuja, Vivian Shen, Cathy Mengying Fang, Nathan Riopelle, Andy Kong, Chris Harrison



https://www.youtube.com/watch?v=_UUVvssztFk&list=PLqhXYFYmZ-VcAoFsLTdH9hF26jsFkvs2B&index=34

- ハンドヘルドコントローラについたカメラで身体姿勢をキャプチャする
- Capture body posture with a camera attached to a handheld controller

Today's Summary

Measurement of Human perception is necessary for interactive system design.

- 脳活動計測 / Measure **brain activity**.
- 神経・筋活動計測 / Measure **nerve activity**.
- 自律神経系計測 / Measure **autonomic nerve** related phenomenon.
- 運動計測 / Measure **motion**.
- 心理物理実験 / Ask the user (**psychophysics**)

They can be used both as a **evaluation tool**, and **part of an interactive system**

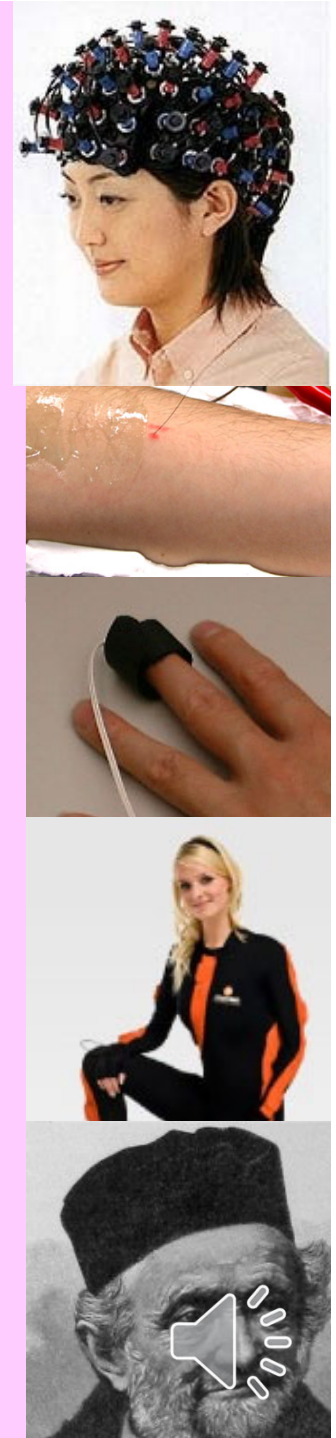

小テスト：一週間以内に提出

Mini Test: Submit in one week

以下の全てに100字以内程度で解答せよ／Answer all questions within 50 words

1. EEGについて説明せよ Explain EEG
2. MEGについて説明せよ Explain MEG
3. MRIについて説明せよ Explain MRI
4. PETについて説明せよ Explain PET
5. NIRSについて説明せよ Explain NIRS
6. 有髄神経と無髄神経の違いについて述べよ Describe difference between myelinated and unmyelinated nerves.
7. 交感神経の活動で生じる現象を3つ挙げよ Quote three phenomena related to SNS(Sympathetic nervous system) activity.

