

Interactive System インタラクティブ システム特論 (2)

Hiroyuki Kajimoto
kajimoto@uec.ac.jp
Twitter kajimoto



Schedule

講義番号/No.	講義日/Date	内容/Contents	pdf	video	レポート締切日/Report Deadline
1	4/05	人間計測手法/Measuring Human	[📄 pdf]2023年版	video 📺	4/12
-	4/12	出張のため休講/Class cancelled			
2	4/19	視覚/Human Vision System	[📄 pdf] 2023年版	video 📺	4/26
3	4/26	視覚センシング/Visual Sensing	[📄 pdf] 2023年版	video 📺	5/3
4	5/10	視覚ディスプレイ/Visual Display	[📄 pdf] 2023年版	video 📺	5/17
-	5/17	出張のため休講/Class cancelled			
5	5/24	聴覚、聴覚インタフェース/Auditory Interface	[📄 pdf] 2023年版	video 📺	5/31
-	5/31	出張のため休講/Class cancelled			
6	6/7	触覚、触覚インタフェース/Tactile Interface	[📄 pdf] 2023年版	video 📺	6/14
7	6/14	触覚、触覚インタフェース2/Tactile Interface2	[📄 pdf] 2023年版	video 📺	6/21
8	6/21	力覚、力覚インタフェース/Haptic Interface	[📄 pdf] 2023年版	video 📺	6/28
9	6/28	移動感覚インタフェース/Locomotion Interface	[📄 pdf] 2023年版	video 📺	7/5
-	-	プレゼンビデオ提出締切/Presentation video upload	[📄 pdf]	-	7/12
-	-	プレゼンビデオ評価 (1) /Watch group 1 video	-	-	7/19
-	-	プレゼンビデオ評価 (2) /Watch group 2 video	-	-	7/26
-	-	プレゼンビデオ評価 (3) /Watch group 3 video	-	-	8/2



人間計測手法／Measuring Human

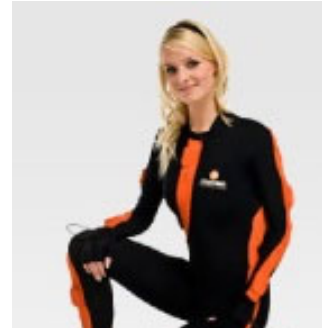
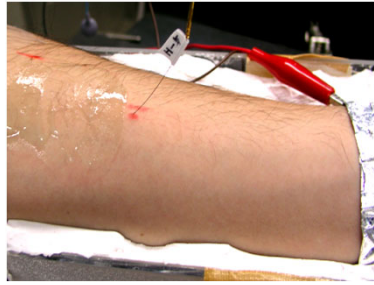

意志から行動までの「どの経路を測るか」で5つの段階
Five layers, *from our initial will to our perception.*

- 脳活動計測／Measure **brain activity**.
- 神経・筋活動計測／Measure **nerve activity**.
- 自律神経系計測／ Measure **autonomic nerve** related phenomenon.
- 運動計測／Measure **motion**.
- 心理物理実験／Ask the user (**psychophysics**)



Psychophysics

- Measure relationship between subjective sensation and physical stimulation.
≡ Measure Human's sensing "ability".
- Important value: "Discrimination threshold"
 - Limitation of "difference of two stimuli" ΔP , which is perceptible
ex)
 - $P=30g \Rightarrow \Delta P=3g$
 - $P=3kg \Rightarrow \Delta P=300g$
- Weber-Fechner's law (1834)
 - $\Delta P / P = \text{Constant}$
Can be applied to most sensation.



Weber-Fechner's Law

- $P = P(S)$
 - P: subjective value of sensation
 - S: physical value of stimulation
 - ΔP = subjective “scale” of sensation
- $\Delta P/P = \text{Constant}$
 - Integral of both sides gives

$$S \propto \log P$$



Weber
(1795~1878)

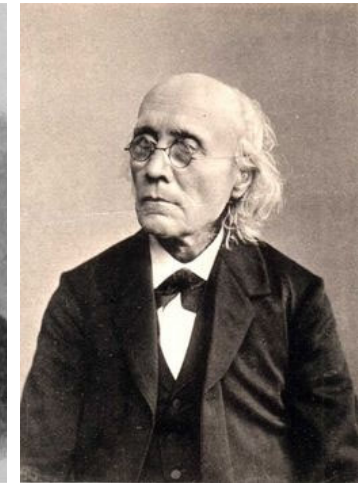

Fechner
(1801~1887)

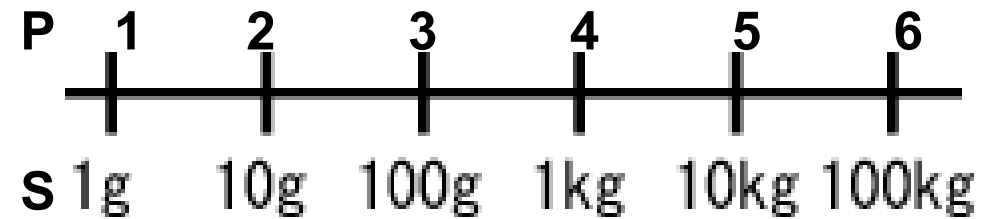

- Conclusion: Our internal “scale” is logarithmic

- ex:
 - Audio's rotary volume

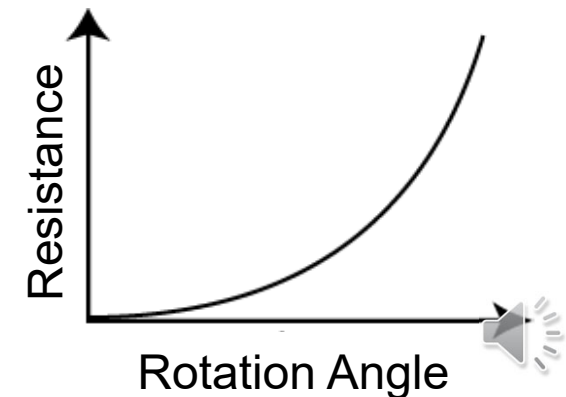

Why Log? Why not Linear?

Our nerve quantizes the phenomenon by impulses.
When we have only 6 scales...

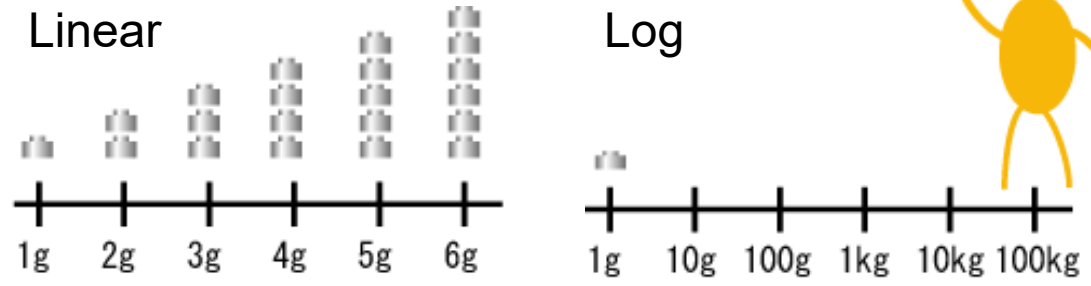
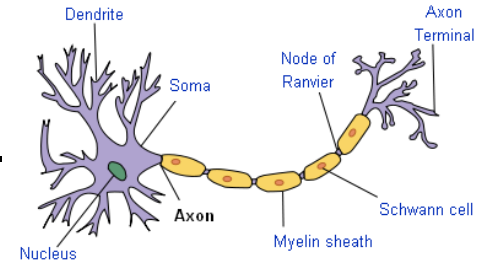

By using Log scale, we can perceive more phenomena.

(ex) CCD cam: 20dB ~ 30dB
Huma Eye: 80dB (Can see stars and sun)



Method of Psychophysical experiment

Purposes

- Measure “Discrimination Threshold” (DT), which gives ΔP
- Measure “Point of Subjective Equality” (PSE).
 - Perceive two different stimuli as “same”.



Discrimination Threshold (DT)
= What is the necessary difference
for discrimination

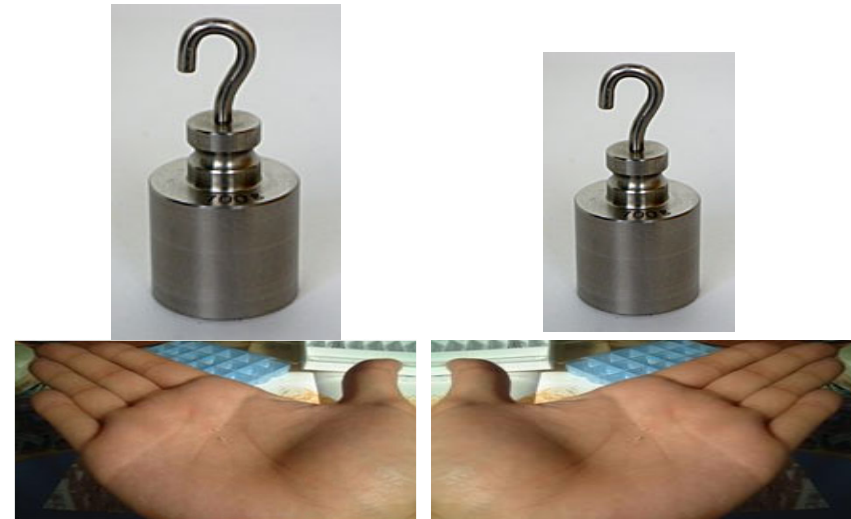

Point of Subjective Equality (PSE)
= What is the value of left weight, which can
be perceived as “same” as the right weight.

Major Methods:

Method of Adjustment, Method of Limit, Method of Constant



● 調整法 / Method of Adjustment
被験者が調整する

● 極限法 / Method of Limit
実験者が調整する

● 恒常法 / Method of Constant
調整せず回答の確率分布を見る

Easy,
Rough

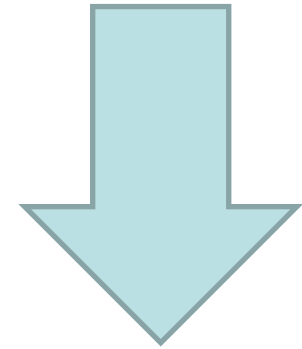

Time Consuming,
Precise



調整法 / Method of Adjustment

カフェウォール図形：確かに水平

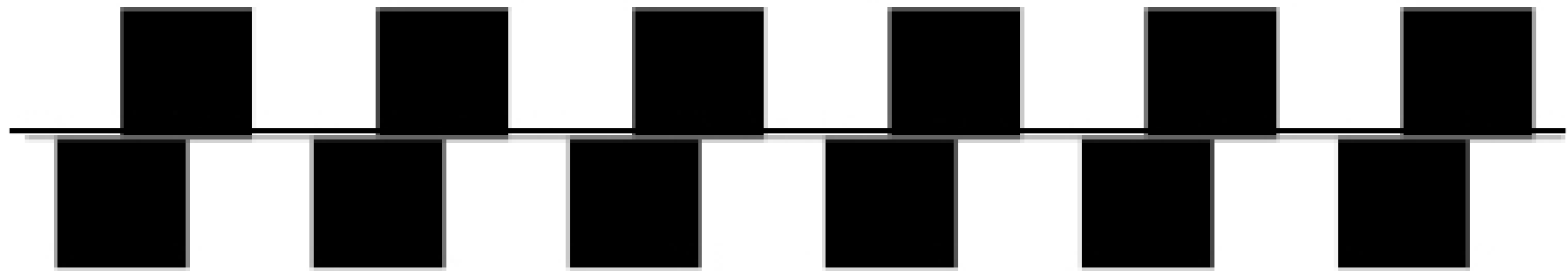

調整法 / Method of Adjustment

標準刺激 / Standard Stimulus

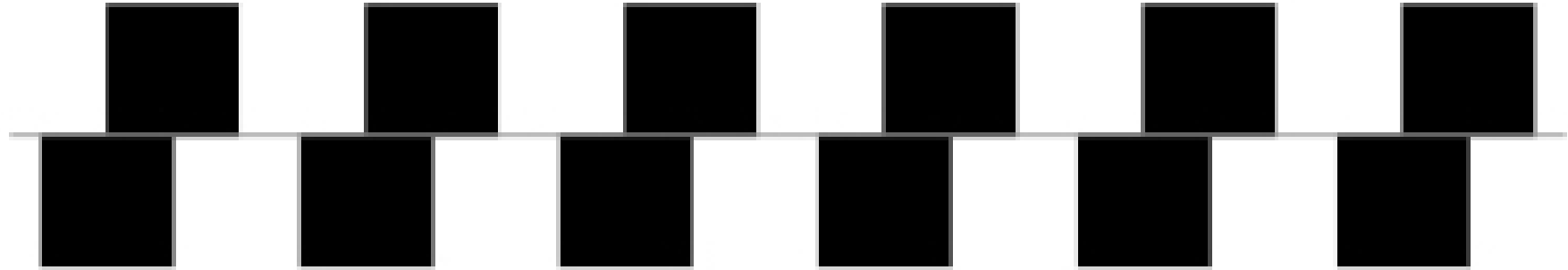

比較刺激 / Comparison Stimulus



標準刺激の方が傾いて見られる筈刺激を瘦し回転

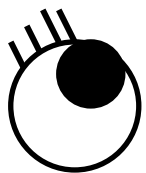

極限法 / Method of Limit

ミュラー・リヤー錯視
確かに同じ長さです



極限法 / Method of Limit

1. 下降系列 / Descending Series



同じく比較刺激の方が長で無理や → 回答「小」

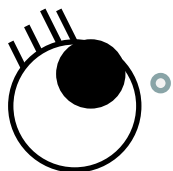

このときの比較刺激の長さ = 上閾値 / Upper Threshold



極限法 / Method of Limit

2. 上昇系列 / Ascending Series

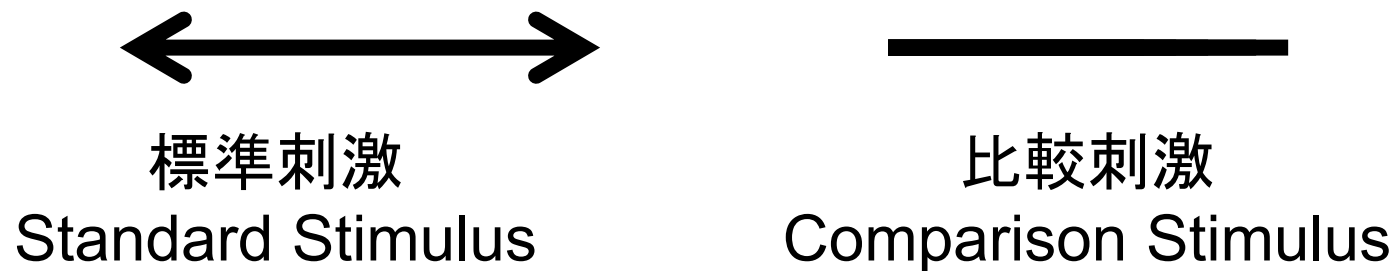

比較刺激の長さ短くして「回答「大」」

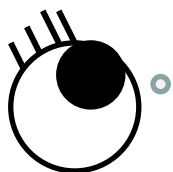

このときの比較刺激の長さ = 下閾値 / Lower Threshold 

極限法 / Method of Limit



閾値の計算

Threshold Calculation

標準刺激: 長さ1.0

上閾値: 0.95

下閾値: 0.85

この結果から,

- 主観的等価点(Point of Subjective Equality)は $(0.85+0.95)/2 = 0.90$
- 弁別域(Discrimination Threshold)は $(0.95-0.85)/2 = 0.05$

つまり, この「矢印の錯視」によって,

- 長さが0.9に縮んで見えることと,
- 長さの弁別能力が0.05程度であることが分かった.



恒常法 / Method of Constant

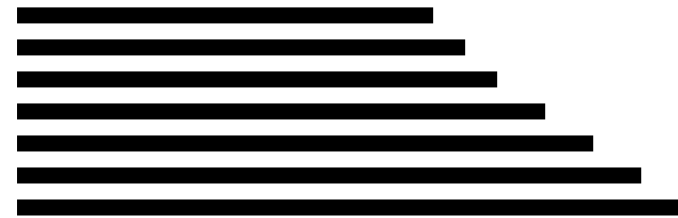

標準刺激

Standard Stimulus

比較刺激

Comparison Stimulus

1. 比較刺激を複数用意する(例では7個)
2. 一個の比較刺激あたりの実験回数を例えば20回とする
3. 合計 $7 \times 20 = 140$ 回、「ランダムに」比較し、強制二択させる

比較刺激	「比較刺激の方が長い」	「比較刺激の方が短い」
0.7	1	19
0.8	3	17
0.9	9	11
1.0	15	5
1.1	17	3
1.2	19	1
1.3	20	0



恒常法 / Method of Constant

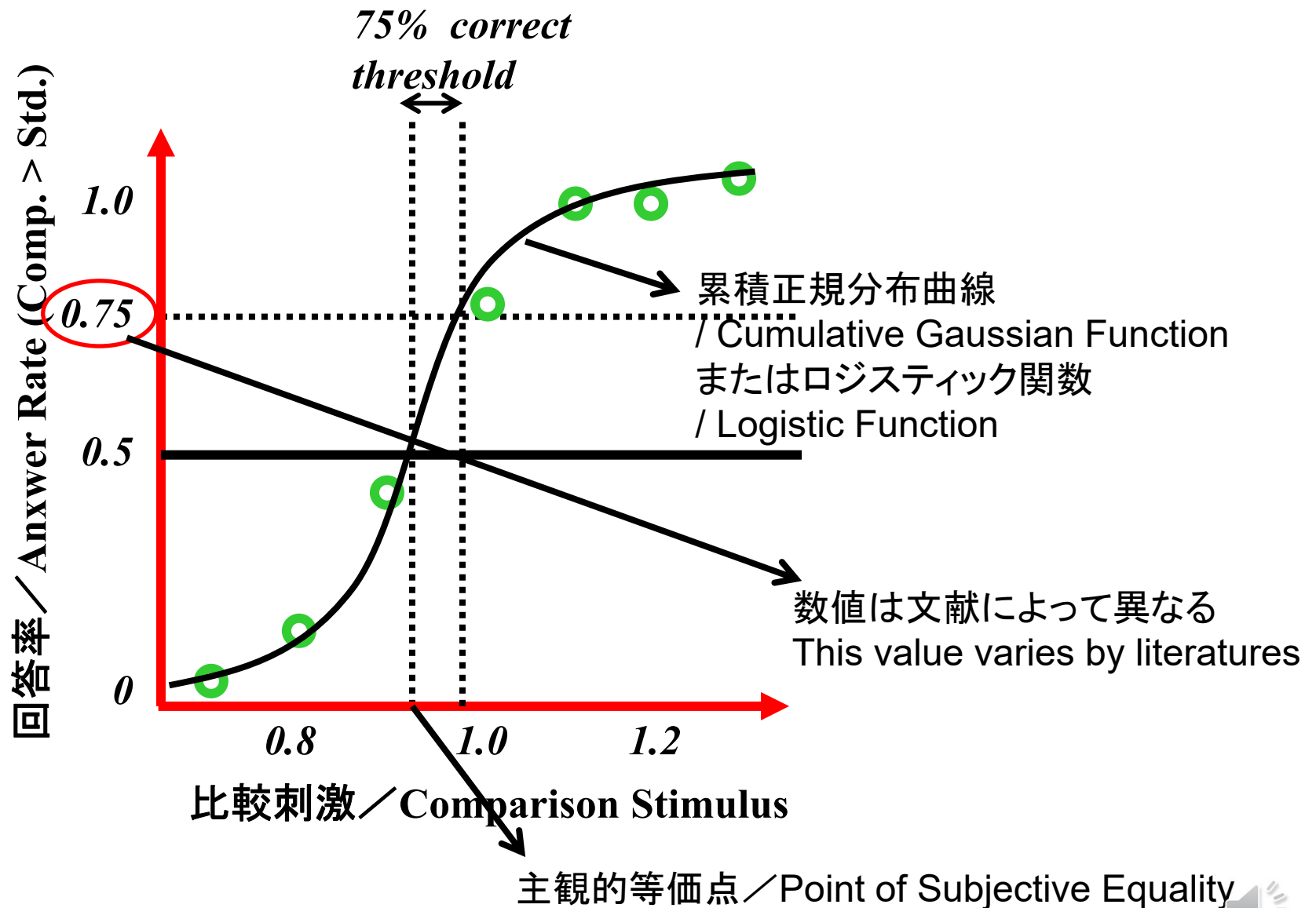

Summary

Measurement of Human perception is necessary for interactive system design.

- 脳活動計測／Measure **brain activity**.
- 神経・筋活動計測／Measure **nerve activity**.
- 自律神経系計測／ Measure **autonomic nerve** related phenomenon.
- 運動計測／Measure **motion**.
- 心理物理実験／Ask the user (**psychophysics**)

They can be used both as a **evaluation tool**, and **part of an interactive system**

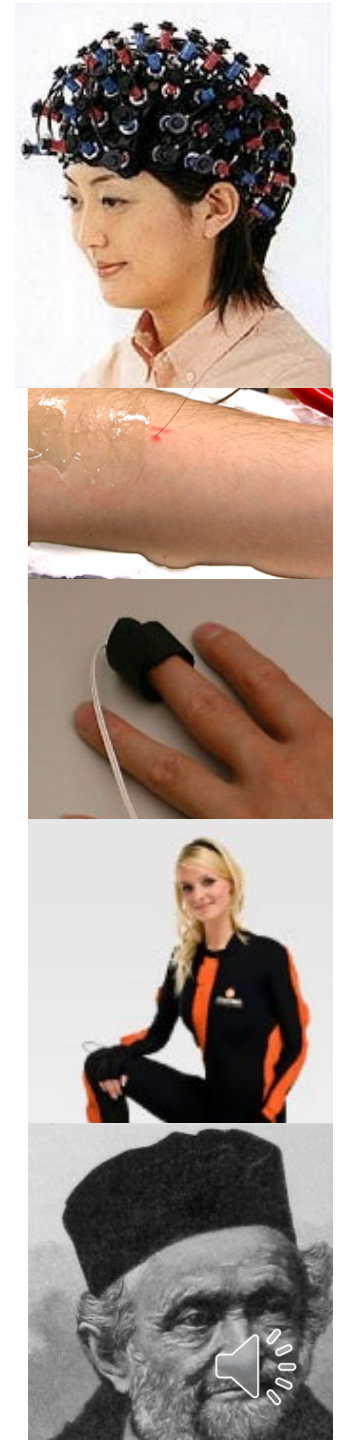

Outline of the lecture

1. 人間計測手法／Measuring Human
2. 視覚／Human Vision System
3. 視覚センシング／Visual Sensing
4. 視覚ディスプレイ／Visual Display
5. 聴覚、聴覚インタフェース／Auditory Interface
6. 触覚、触覚インタフェース／Tactile Interface
7. 力覚、力覚インタフェース／Haptic Interface
8. 移動感覚インタフェース／Locomotion Interface

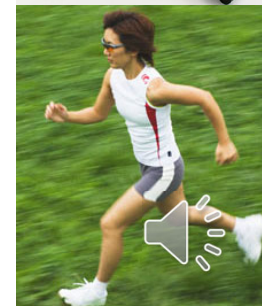

TODAY'S TOPIC

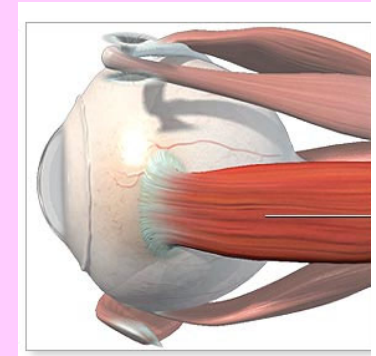
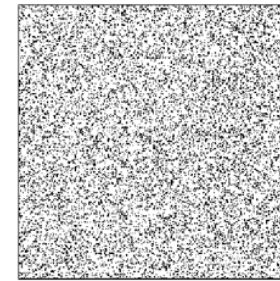
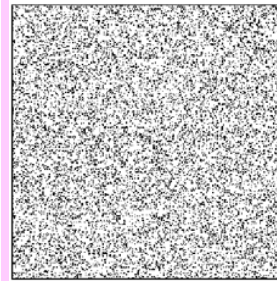
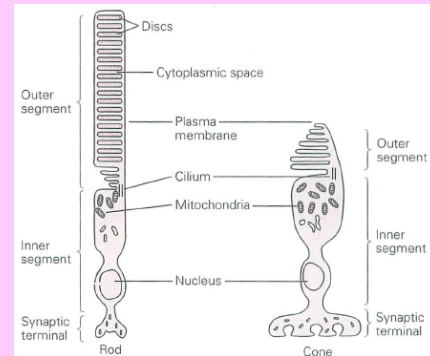
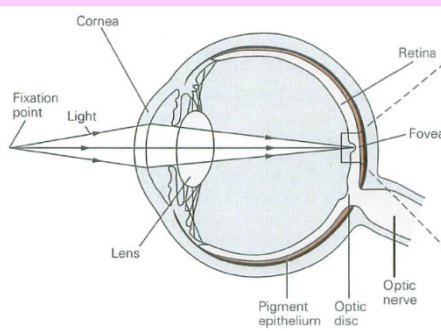

- 目の構造 / Eye structure
- 目のセンサ / Eye sensors
- 奥行き知覚 / Depth perception
- 眼球運動 / Eye movement



眼の構造／Eye Structure

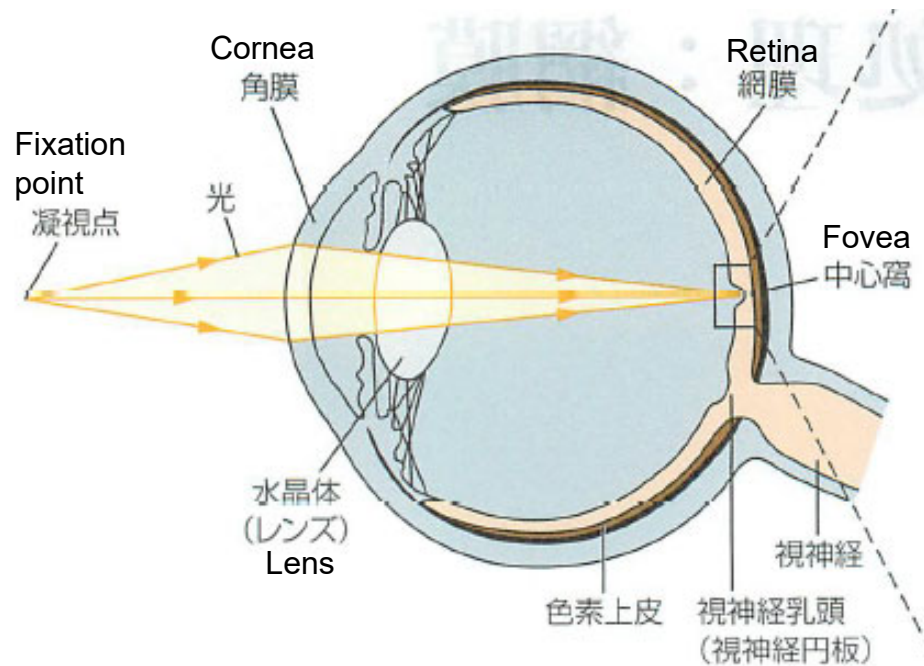

カandel神経科学(Principles of Neural Science)
<https://www.medsai.co.jp/kandel/syousai/index.html>

- 角膜／Cornea: surface lens
 - LASIK: Laser in Situ Keratomileusis
- 水晶体／Lens: Internal lens.
 - Focal length is adjustable by deformation.
- 虹彩／Iris: Adjust amount of light.
- 網膜／Retina: Light sensor

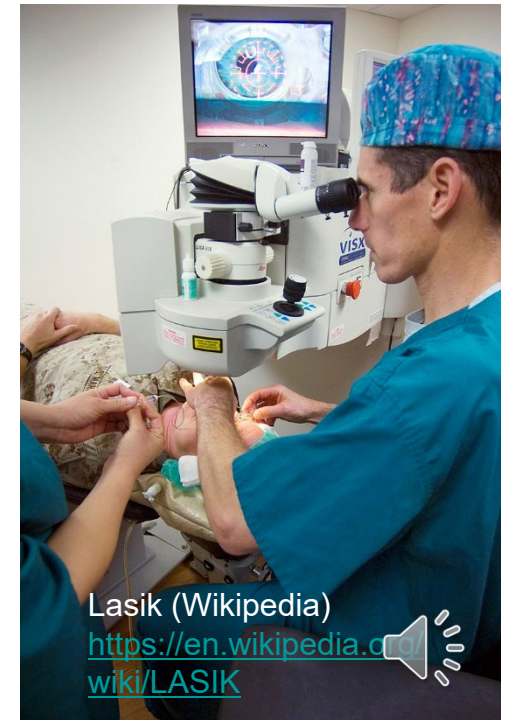

カメラとの比較／Comparison with Camera

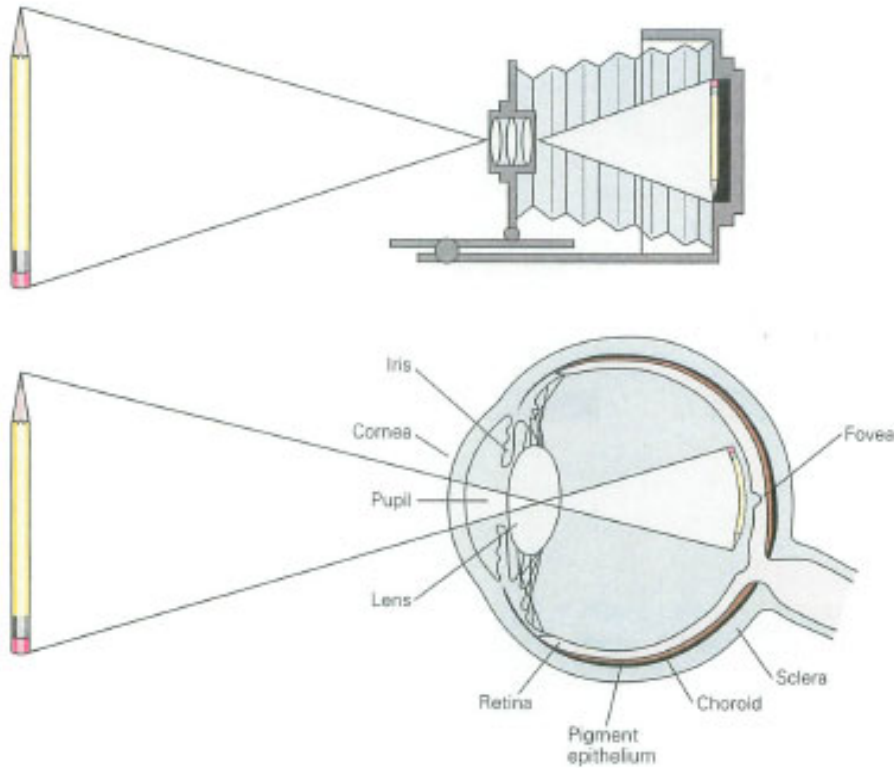

- レンズ／Lens
Camera: 1
Eye: 2
- 虹彩／Iris: same
- センサ／Sensor
Camera: Film or CCD
Eye: Retina

- One apparent difference = Focal length adjustment(焦点調節)
 - Camera: Shift lens
 - Eye: Deform lens



網膜／Retina = Optical Sensor

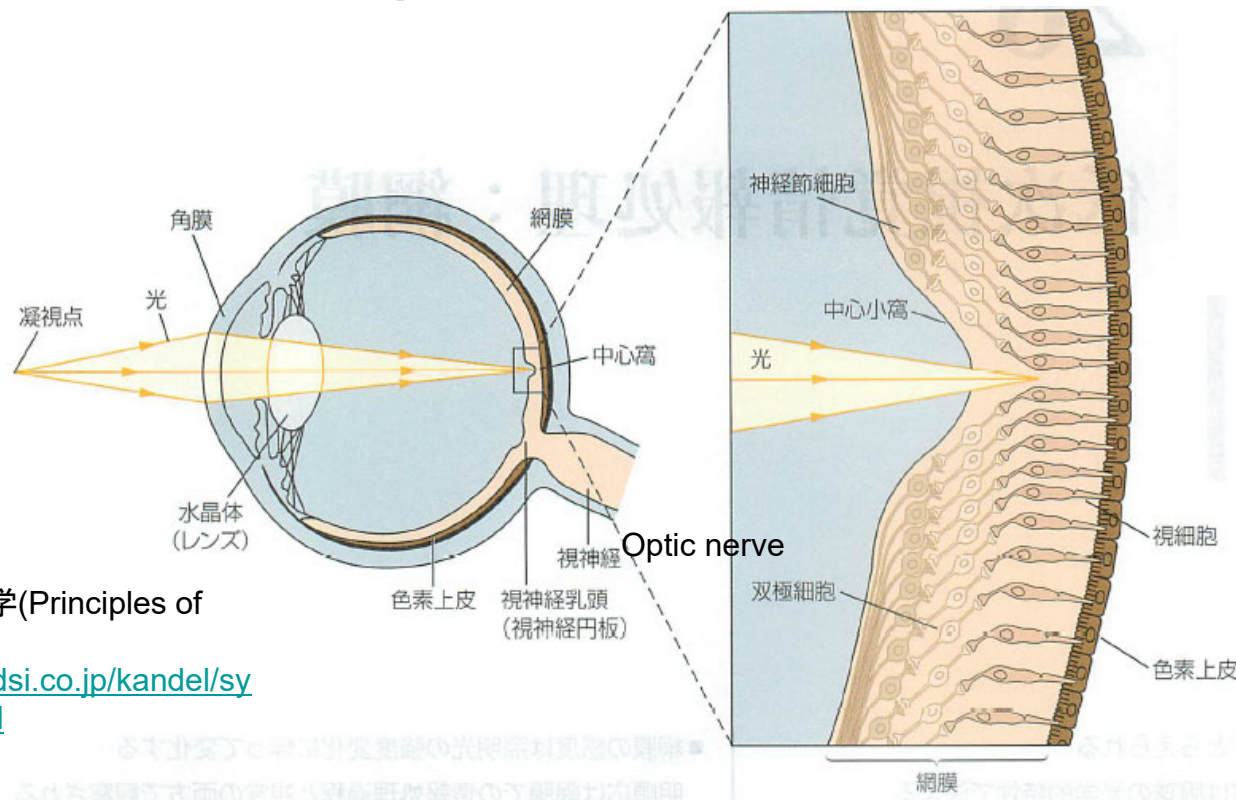

カandel神経科学(Principles of Neural Science)
<https://www.medsci.co.jp/kandel/syousai/index.html>

- 中心窩／Fovea: Center of vision. Very high spatial resolution.
- Optic nerve: Nerve from retina to brain.

Optic nerve is **in front of** the retina. (transparent)

- 盲点／Optic disc (blind spot): Hole that optic nerve axons exit.

盲点 / Blind Spot

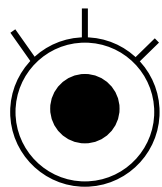

- Close your right eye, and gaze '+' with your left eye.
- Move the paper back and forth, and find  disappears.
- You also find the fish line connected.



TODAY'S TOPIC

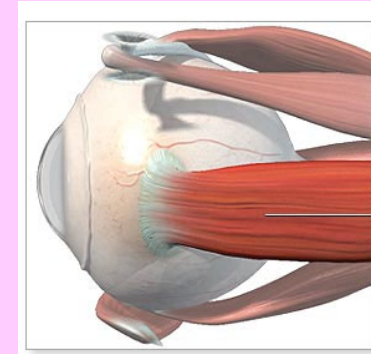
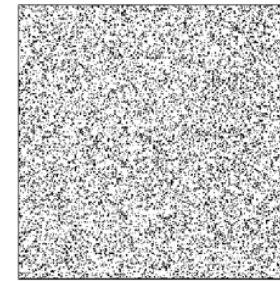
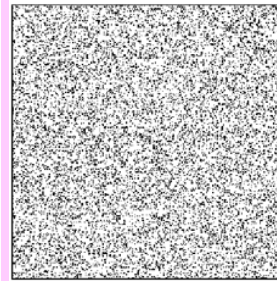
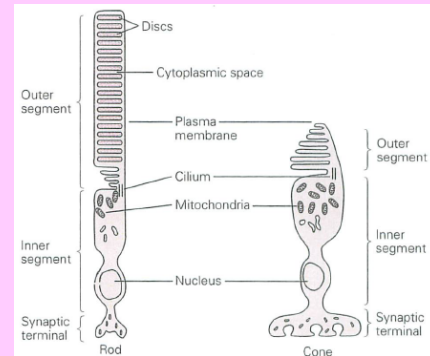
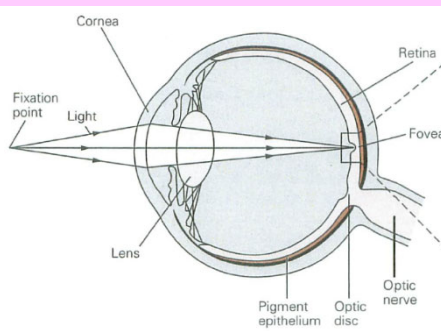

- 目の構造 / Eye structure
- 目のセンサ / Eye sensors
- 奥行き知覚 / Depth perception
- 眼球運動 / Eye movement



網膜の視細胞 / Optic cells in the retina

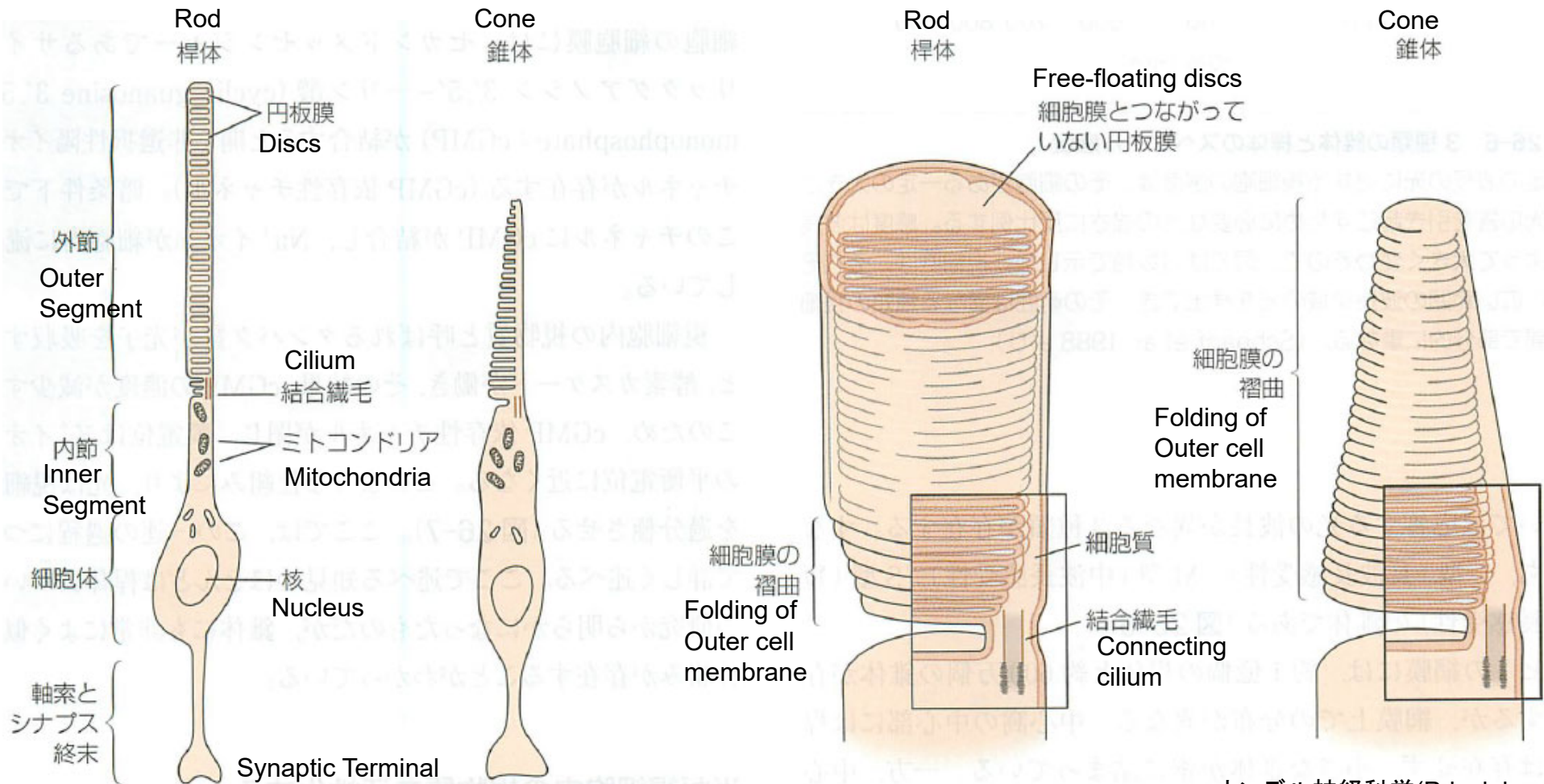

- Rod Cell (桿体細胞) and Cone Cell (錐体細胞)
 - Light to electric conversion is done at outer segment.
 - Channels composed of protein is opened by the light.
 - Rod cell has longer outer segment.

カンデル神経科学(Principles of Neural Science)
<https://www.medsj.co.jp/kandel/syousai/index.html>



桿体細胞 / Rod cell

- **Black and White sensor.**
- Plays major role when dark
- High sensitivity (x100 cone cell)
 - Can capture single photon
- One eye has 130,000,000 cells.
- Slow response.

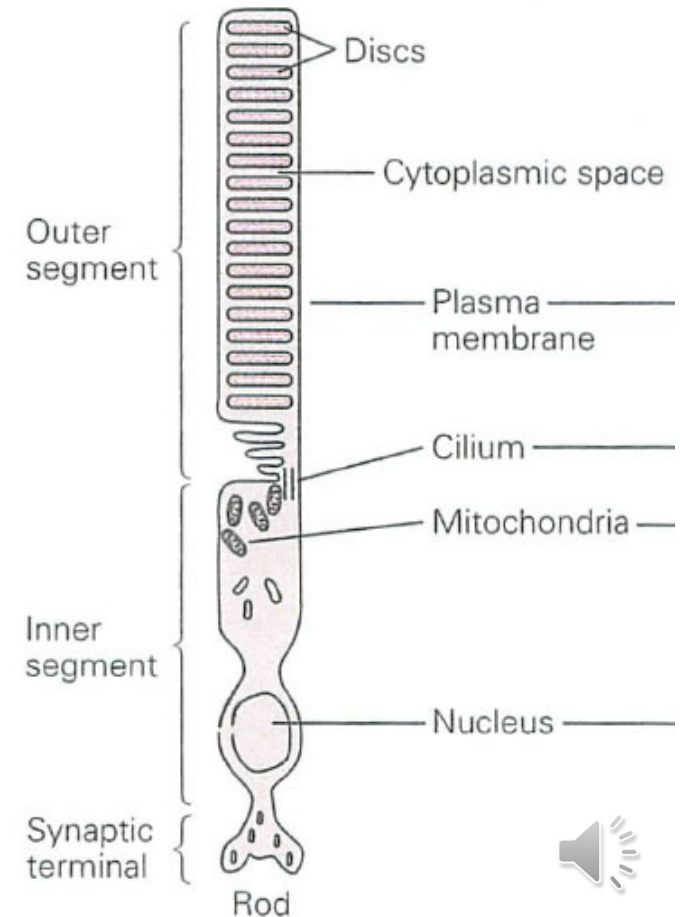

錐体細胞 / Cone cell

- **Color sensing**
 - Three types (L,M,S)
 - Caused by different proteins in the channel.
- Play major role when bright.
- Has lower sensitivity.
- One eye has 7,000,000.
- **Clustered at fovea (中心窩).**
- Fast Response.

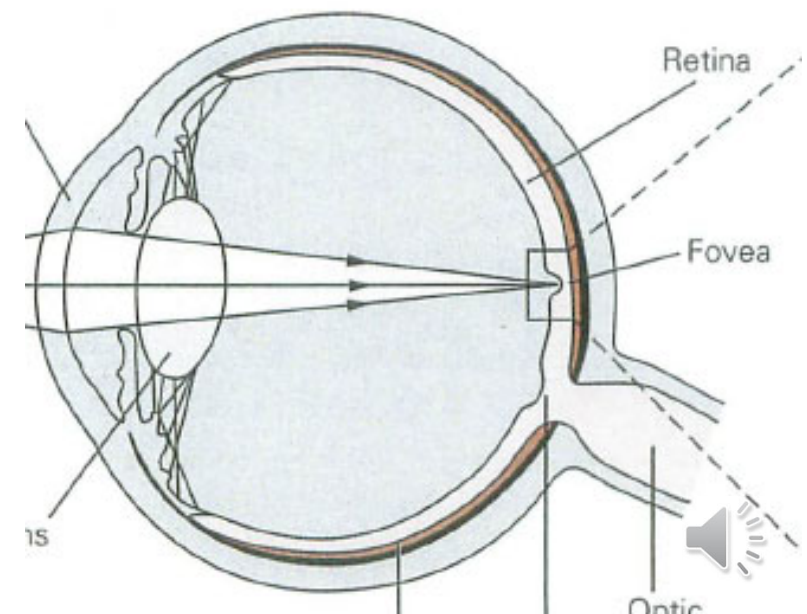
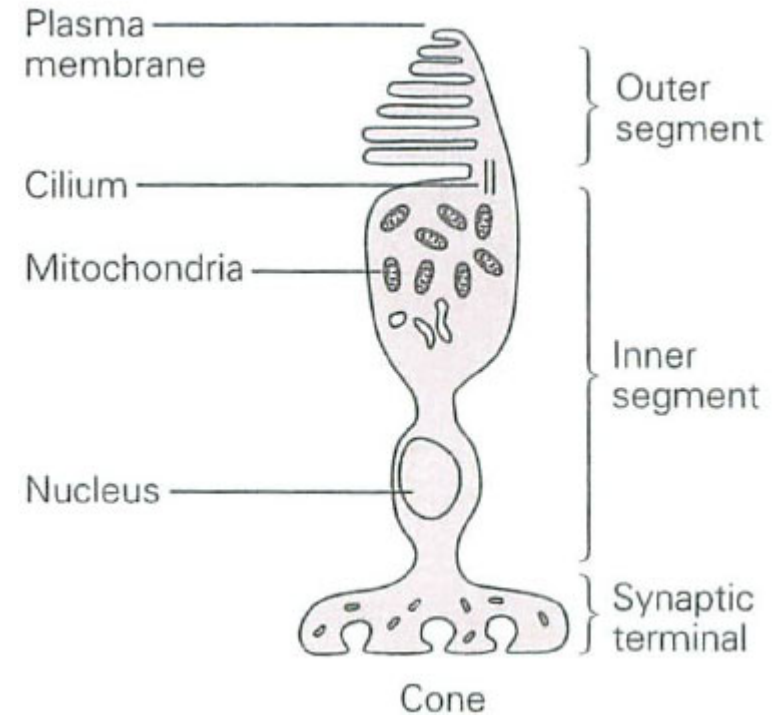

桿体細胞・錐体細胞 / Rod cell & Cone cell

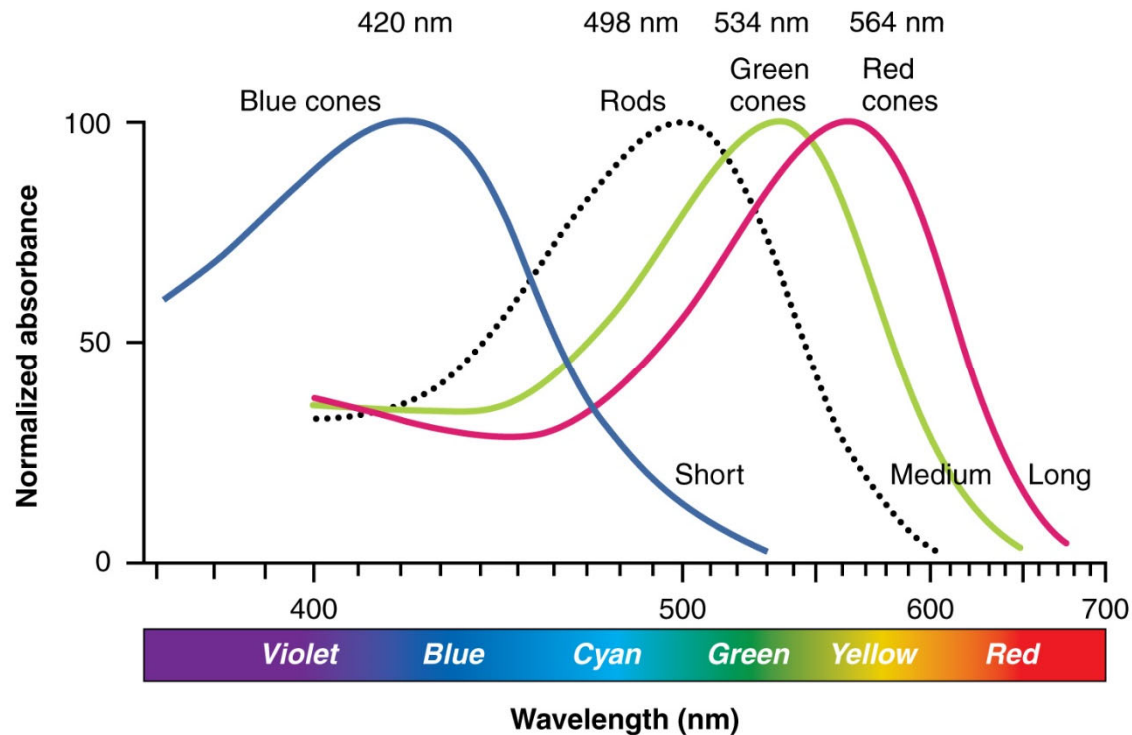

Photoreceptor Cells (Wikipedia)
https://en.wikipedia.org/wiki/Photoreceptor_cell

- Rod cell: black & white sensor.
 - peak = 498nm.
 - Green Laser Pointer is the best for presentation.
- Cone cell: Three types
 - S: 420nm, M: 534nm, L: 564nm
 - Color perception is based on the combination of the three.



桿体・錐体の分布 / Distribution of the cells.

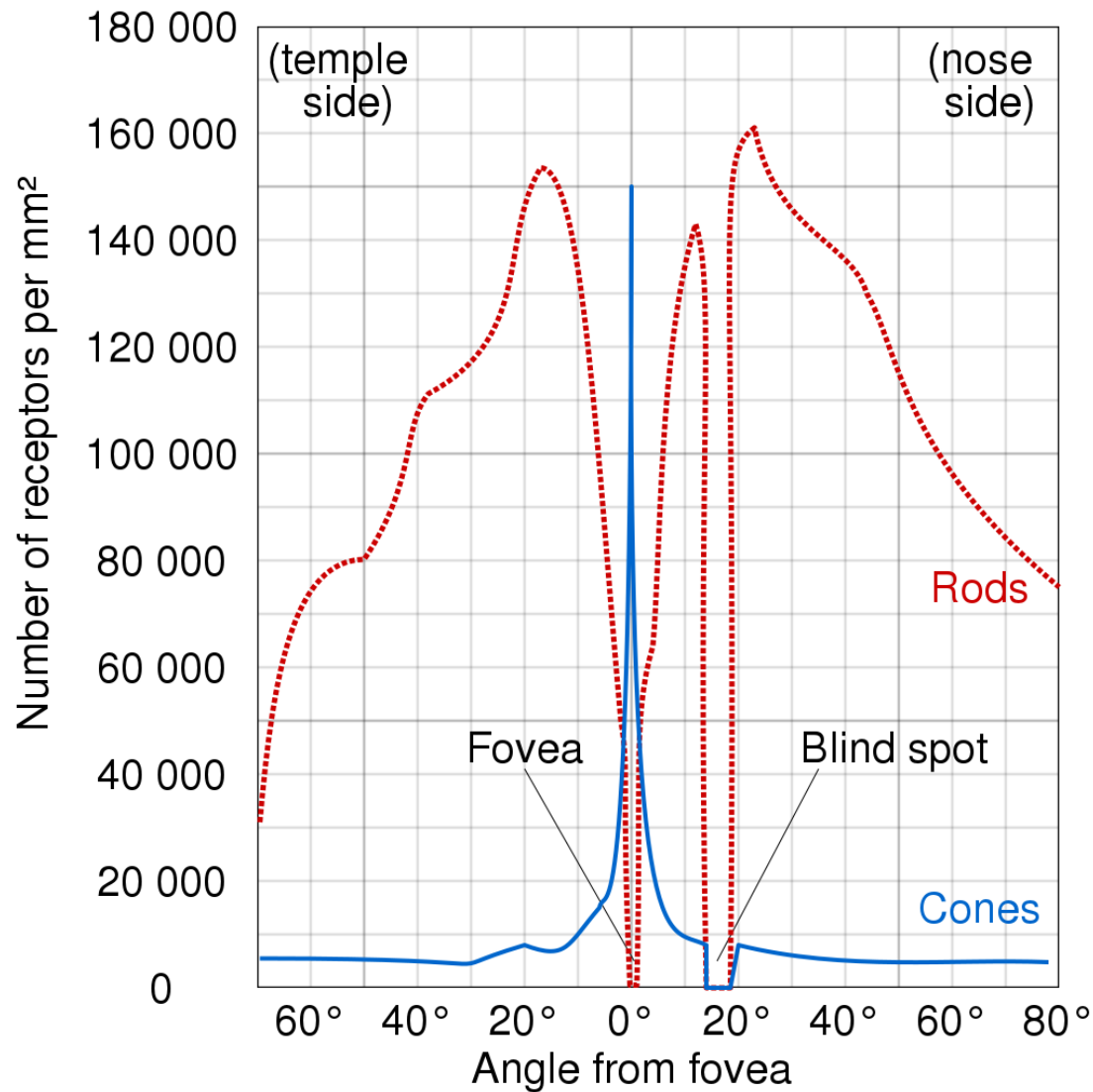

- Cone cell = central vision (中心視)
 - ✓ Peripheral vision is almost color blind
- Rod cell = peripheral vision (周辺視)
 - ✓ You can see stars better by peripheral vision



周辺視野への情報呈示(1)/Peripheral Display



<https://www.youtube.com/watch?v=QLB0RkmKbSQ>

T. Nojima, Y. Saiga, Y. Okano, Y. Hashimoto, H. Kajimoto, "The Peripheral Display for Augmented Reality of Self-Motion", ICAT2007.

- 周辺視野への呈示は臨場感を呈示するために不可欠
- 周辺視野は空間解像度は低い。
- 周辺視野のほうが時間的解像度(CFF:Critical Fricker Frequency)は高い
⇒LEDマトリクスで運動呈示
- 右の動画のように下につけて地面の流れを出すのがポイント
(関連知見: 深澤「ヴェクションにおける地面優位効果」H18年度東京大学卒業論文)



周辺視野への情報呈示(2)/Peripheral Display

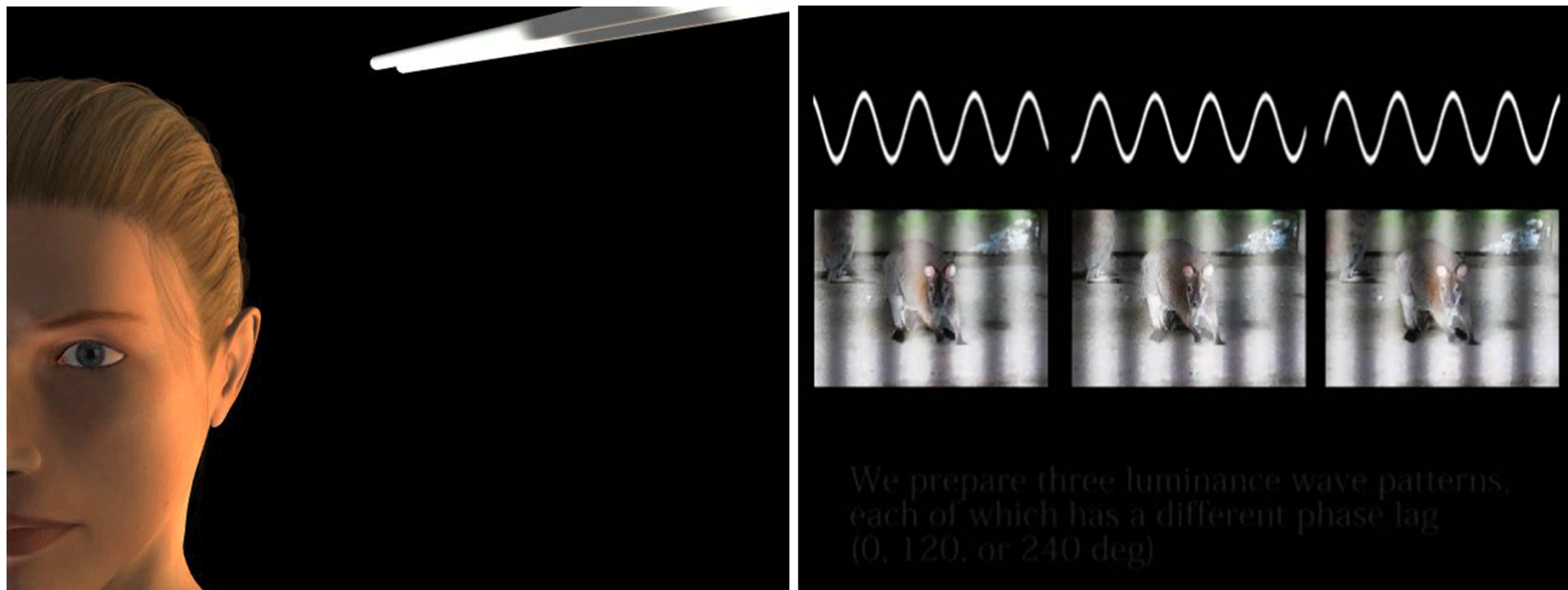

Y. Okano, S. Fukushima, M. Furukawa, H. Kajimoto, "Embedded Motion", SIGGRAPH Asia 2010, Poster, Korea.

- 周辺視野のほうが時間的解像度(CFF:Critical Fricker Frequency)は高いことを利用すると、周辺視野にだけ知覚可能な「チラツキ」を運動情報提示として利用できる。
- 見たところがつねに中心視野になるので、視線検出も不要。



周辺視野への情報呈示(3)

(CHI2013) Brett R. Jones: IllumiRoom: Peripheral Projected Illusions for Interactive Experiences

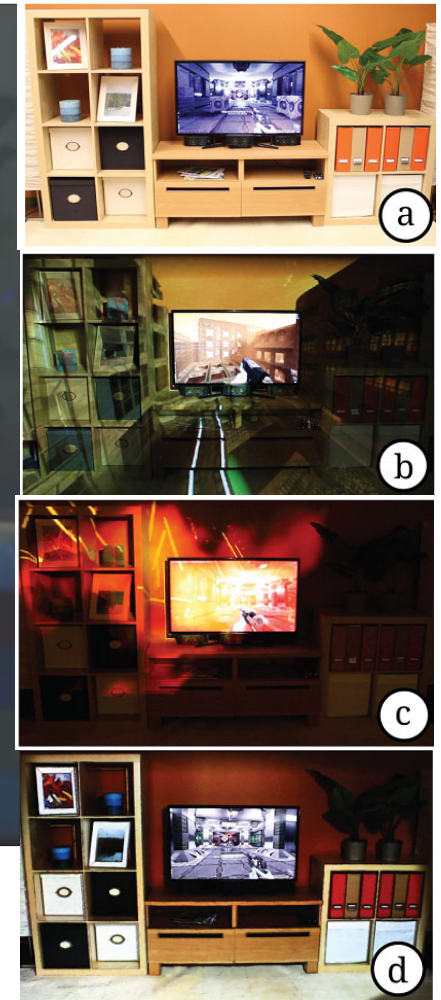

<http://www.youtube.com/watch?v=re1EatGRV0w>



(CHI2016) Augmenting the Field-of-View of Head-Mounted Displays with Sparse Peripheral Displays, Robert Xiao, Hrvoje Benko



<https://www.youtube.com/watch?v=af42CN2PgKs>

HMDに低解像度のLEDを並べて周辺視野を拡張する。



(CHI2018)ExtVision: Augmentation of Visual Experiences with Generation of Context Images for a Peripheral Vision Using DNN

Naoki Kimura, Jun Rekimoto



ExtVision:
Augmentation of Visual Experiences with Generation of Context Images for Peripheral Vision Using Deep Neural Network

Naoki Kimura
University of Tokyo
Tokyo, Japan

Jun Rekimoto
University of Tokyo / Sony CSL
Tokyo, Japan

- https://www.youtube.com/watch?v=D9Mc_P8FZbk
- 周辺視野へのコンテンツ拡張をニューラルネットワークによって行う。



色知覚は空間解像度が低い

Color process has very low resolution



Original



Gray

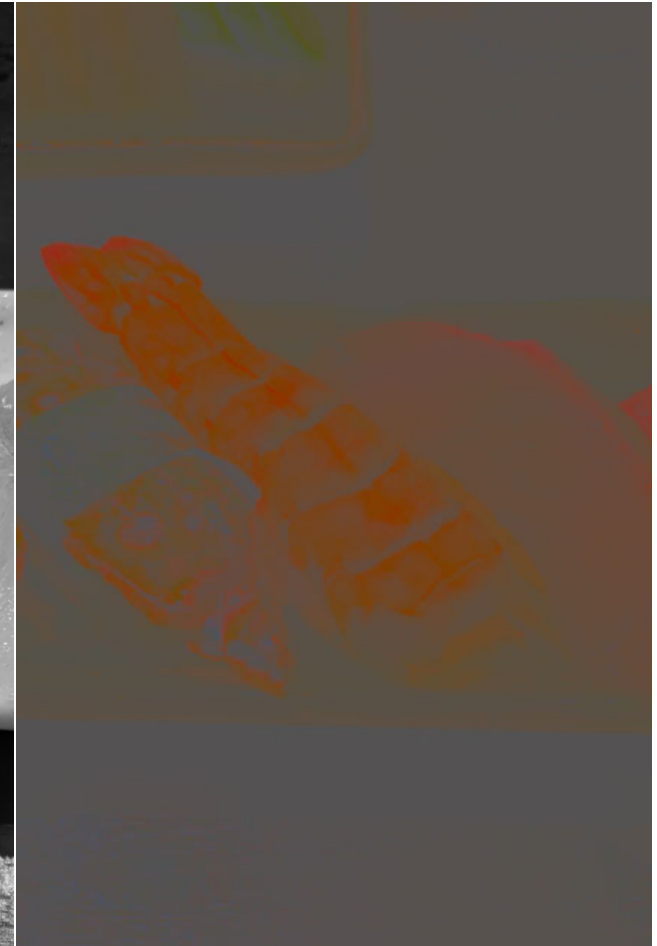

Color only



Color Assimilation Grid Illusion

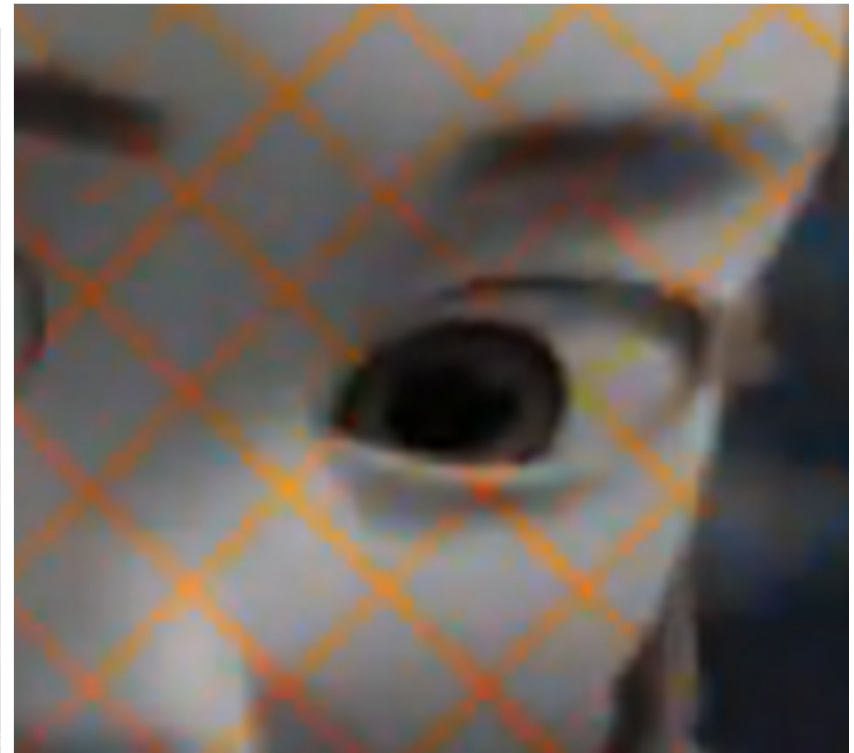

<https://www.youtube.com/watch?v=7jJ10OZH2SU>
<https://nlab.itmedia.co.jp/nl/articles/1908/10/news009.html>

RGB and YCbCr(YUV, Lab)

RGB: corresponds to 3 cone cells.

Mathematics tells us...

ANY 3 independent vectors can be basis vectors

YCbCr (YUV):

- Y(brightness)
- Cb(color axis 1)
- Cr(color axis 2)

Similar to brain's color perception

$$Y = 0.257R + 0.504G + 0.098B + 16$$

$$Cb = -0.148R - 0.291G + 0.439B + 128$$

$$Cr = 0.439R - 0.368G - 0.071B + 128$$

Used in image compression

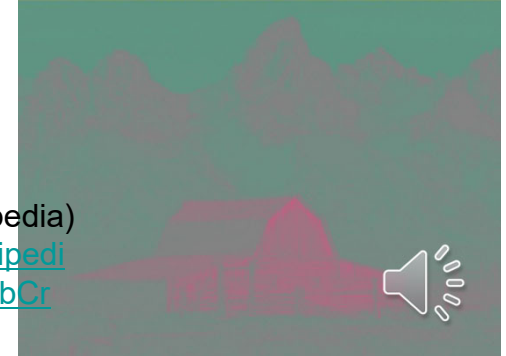
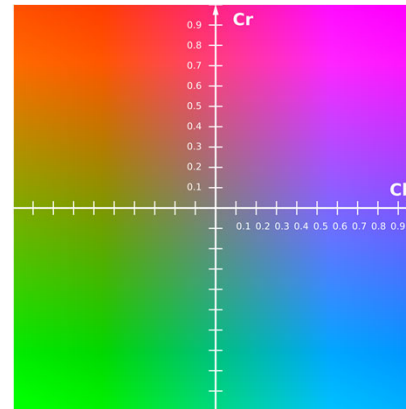

YCrCb (Wikipedia)
<https://en.wikipedia.org/wiki/YCbCr>



色覚のバリエーション／Color blindness

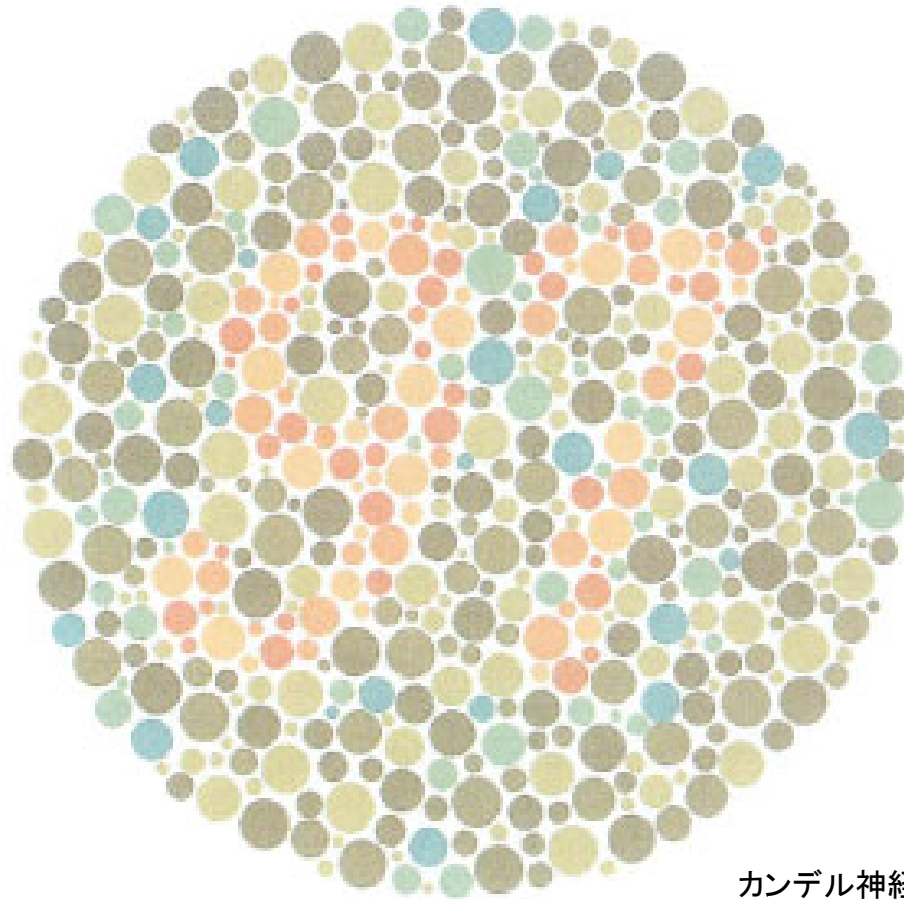

カンデル神経科学(Principles of Neural Science)
<https://www.medsai.co.jp/kandel/syousai/index.html>

- One to three types of cone cells lacks.



色覚のバリエーション／Variety of color sense



「色のふしぎ」と
不思議な社会
2020年代の「色覚」原論
川端裕人

既刊書目

赤緑色盲の場合、グリーン車の座席が開いているかどうかわからない

If you are red-green color blind, you cannot tell if a seat in the green car is open

- <https://www.amazon.co.jp/dp/B08QHPPPT3/>
- https://www.jstage.jst.go.jp/article/vision/33/2/33_97/_article/-char/ja/
- 色覚のバリエーションは連続的である。
- Variation in color vision is continuous.

(CHI2018) ChromaGlasses: Computational Glasses for Compensating Colour Blindness
Tobias Langlotz, Jonathan Sutton, Stefanie Zollmann, Yuta Itoh, Holger Regenbrecht

ChromaGlasses: Computational Glasses for Compensating Colour Blindness

Tobias Langlotz, Jonathan Sutton, Stefanie Zollmann, Yuta Itoh, Holger Regenbrecht

Accepted for ACM CHI 2018



- https://www.youtube.com/watch?v=xx4bPIBtqv0&feature=emb_logo
- 色を区別できるようにするARシステム.



網膜での情報処理 / Retinal image processing

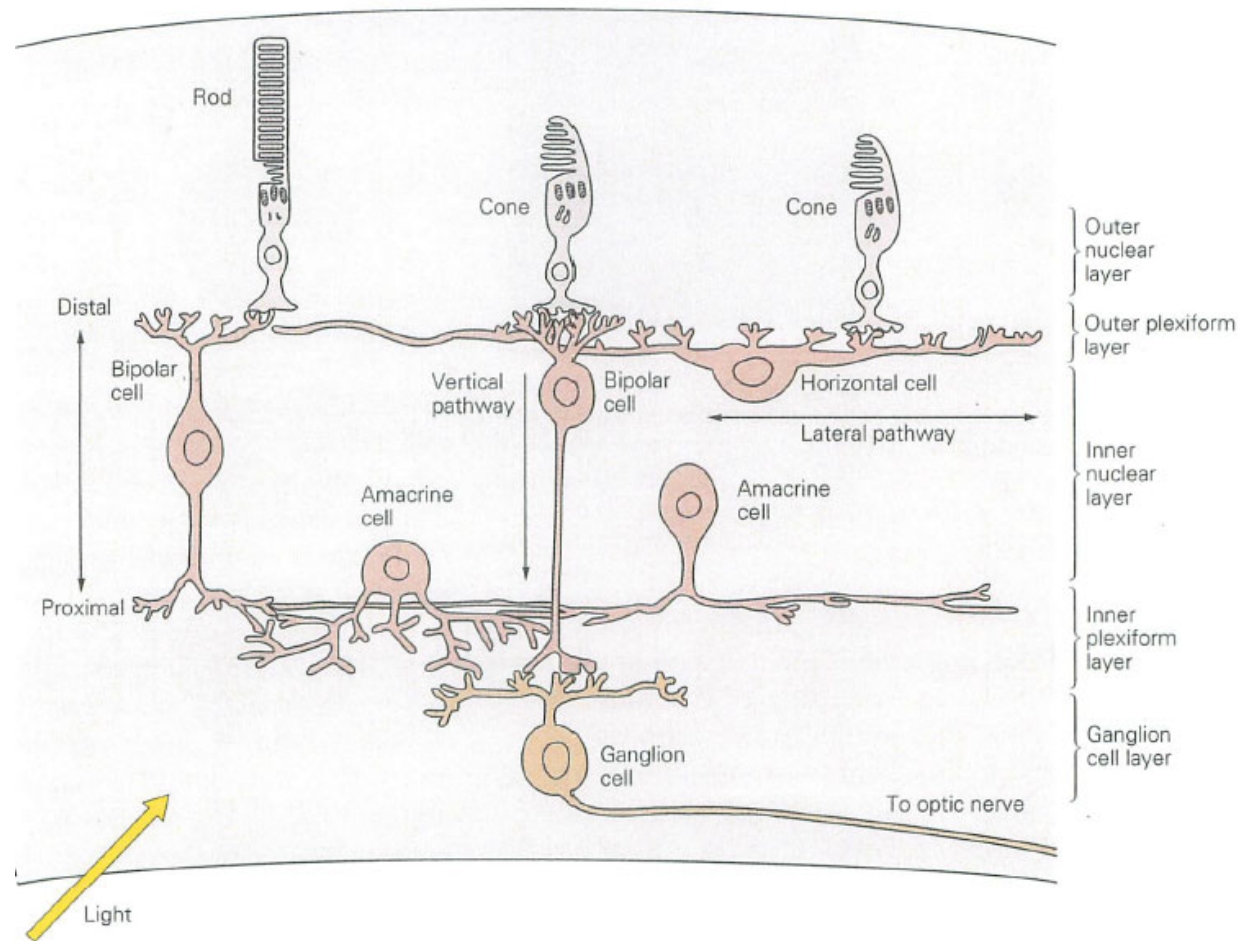

- Sensors: About 200,000,000 / eye
- Nerve axons to the brain: about 1,000,000 / eye
- Retinal image process: 200 cells \Rightarrow 1 output



Key to the retinal process: “Mach belt” illusion

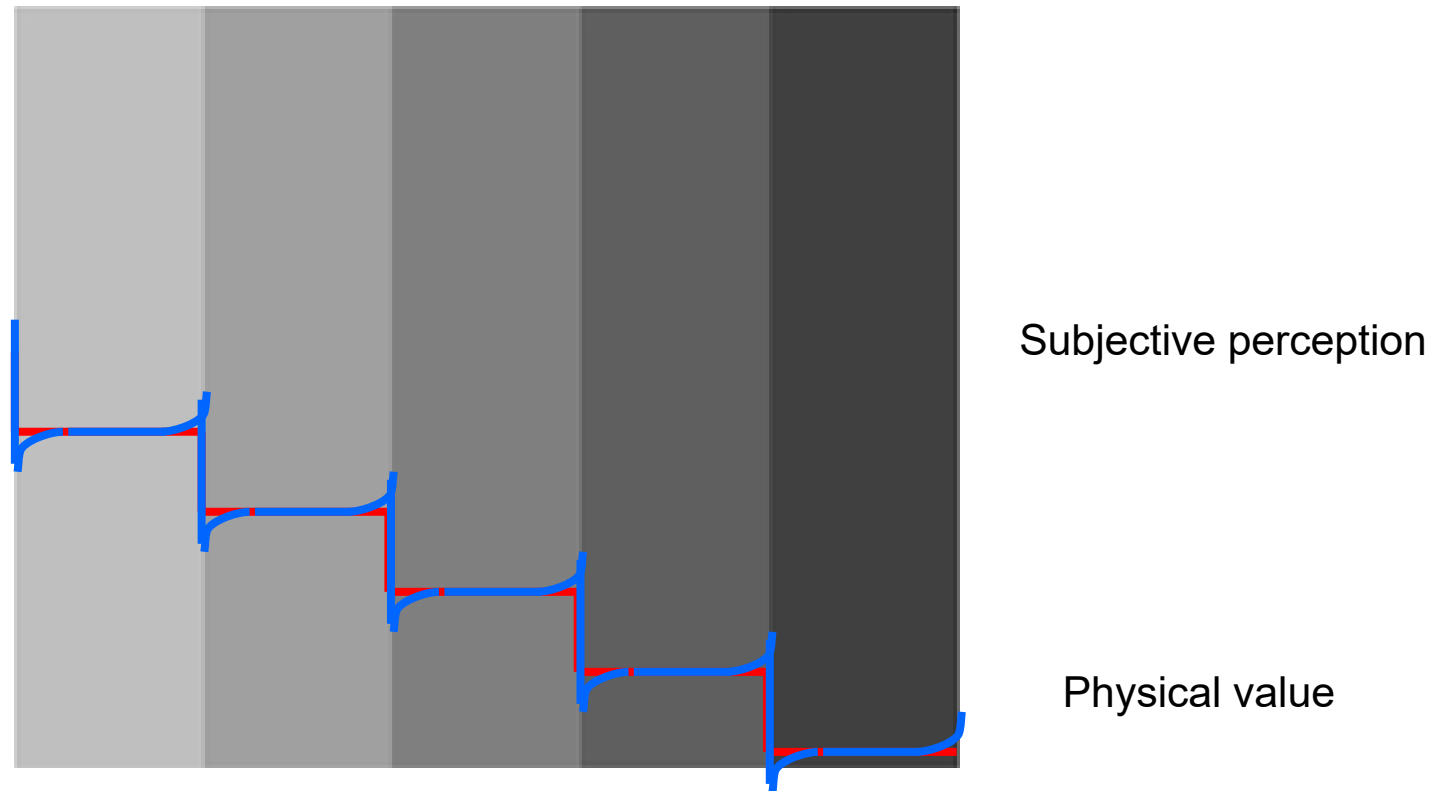

側抑制 / Lateral inhibition

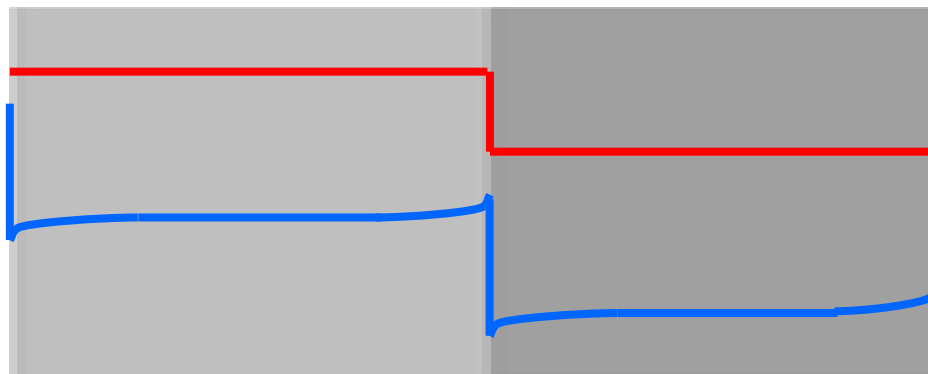
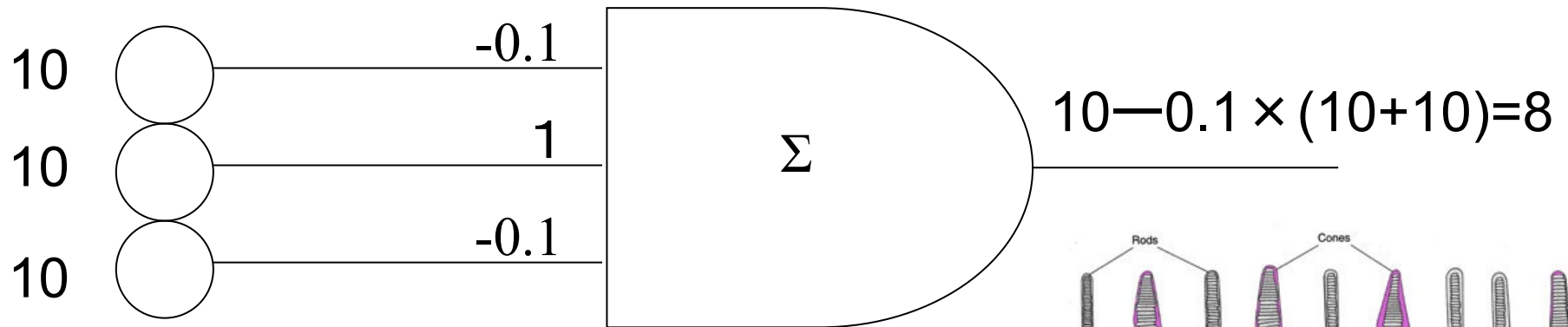

10 10 10 10 10 10 5 5 5 5 5 5
 8.0 8.0 8.0 8.0 8.5 3.5 4.0 4.0 4.0 4.0

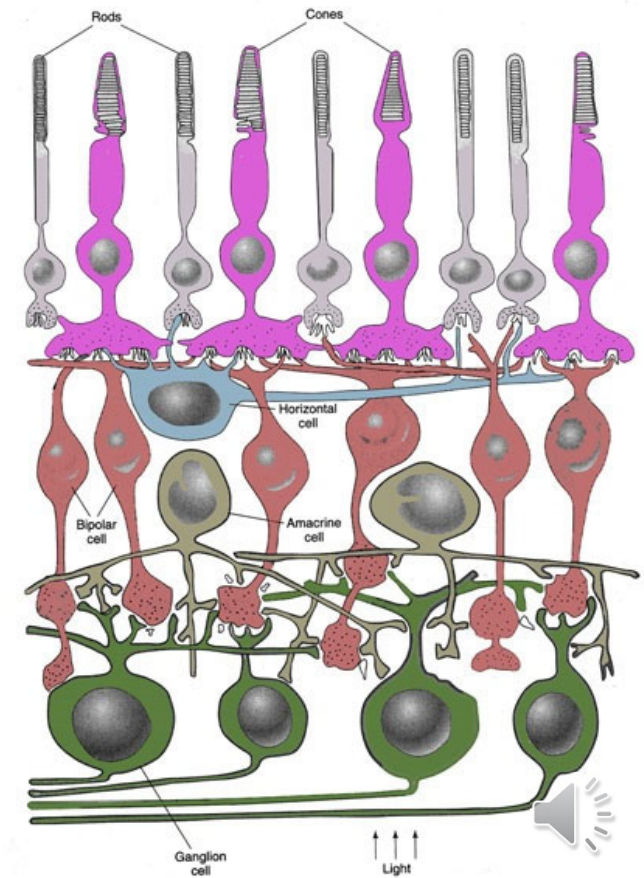

Harman grid illusion

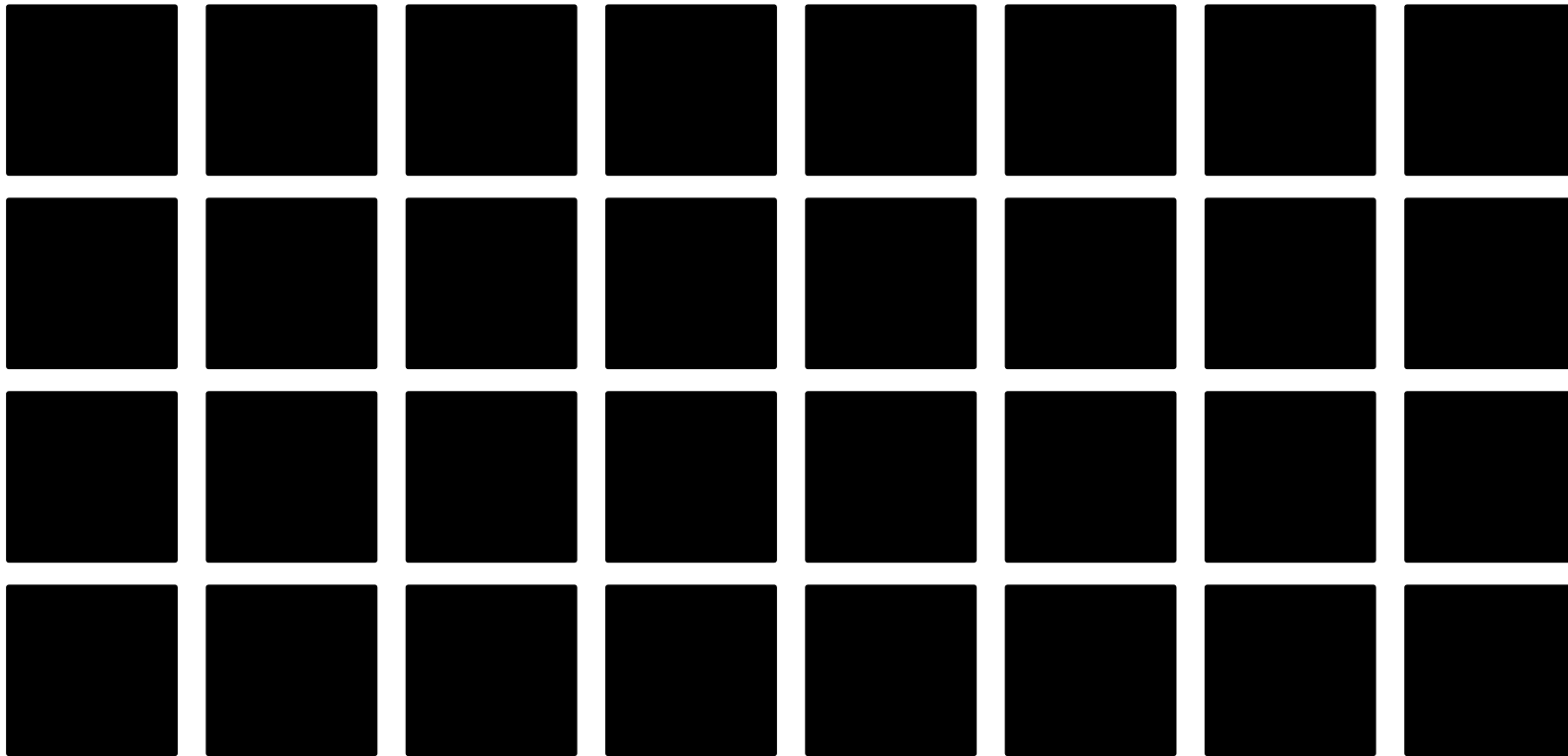

「交差点の周りのほうが、路の周りよりも平均的な明るさが大きい」ために、交差点が暗く感じられる」と説明される。

(1) 周辺視／peripheral vision: the cross point becomes dark, due to lateral inhibition

(2) 中心視／central vision: No such effect

⇒The peripheral vision “compress” larger field.



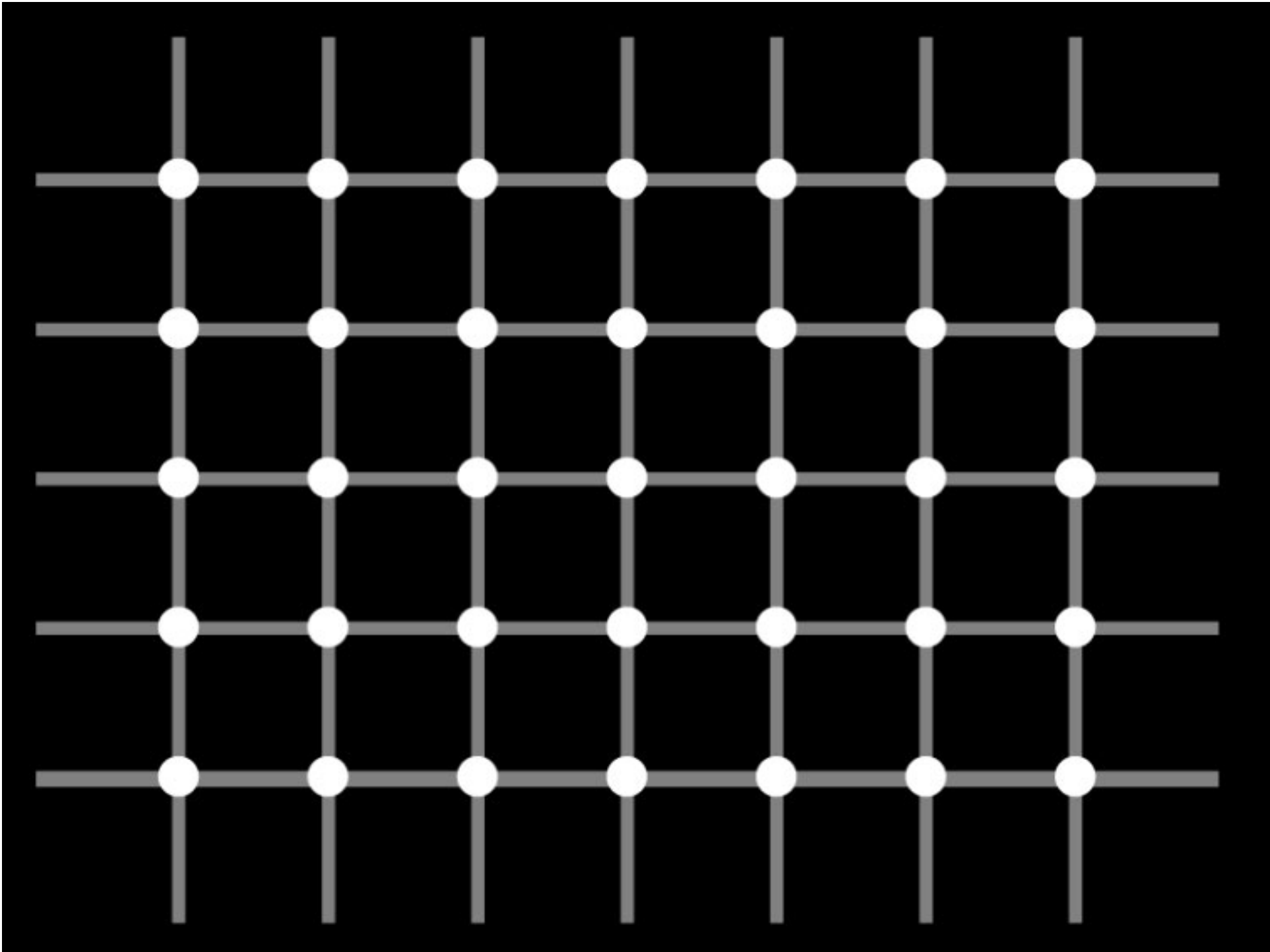

TODAY'S TOPIC

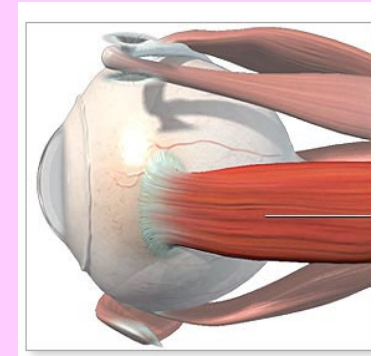
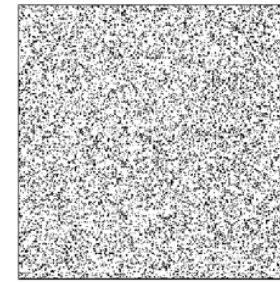
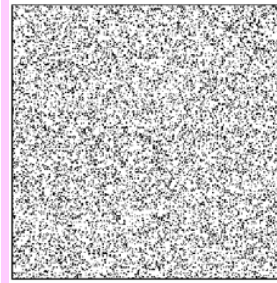
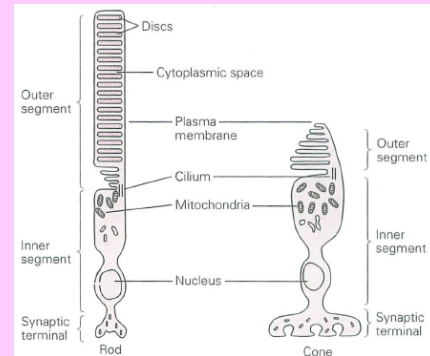
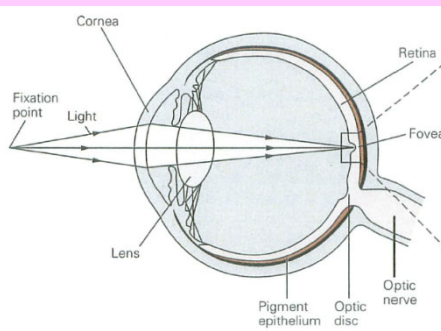

- 目の構造 / Eye structure
- 目のセンサ / Eye sensors
- 奥行き知覚 / Depth perception
- 眼球運動 / Eye movement



奥行き知覚の鍵／Depth perception cues

- 単眼性／With single eye
 - 経験／Experience
 - 焦点調節／Accommodation
 - 運動視差／Motion Parallax



- 両眼性／With two eyes
 - 輻輳角／Vergence eye movement
 - 両眼視差／Binocular disparity

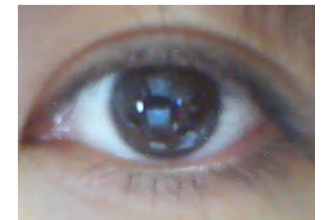

Depth cue(1) 経験／Experience



- 記憶／Memory
Knows the physical size
- 遠近法／Perspective
Near= Large, Bottom, Clear
Far = Small, Top, Blur
- 重なり(遮蔽)／Occlusion
Occluded (shielded) objects are more distant than occluding (shielding) objects.



Depth cue(2) 焦点調節 / Accommodation: Changing the power of the lens

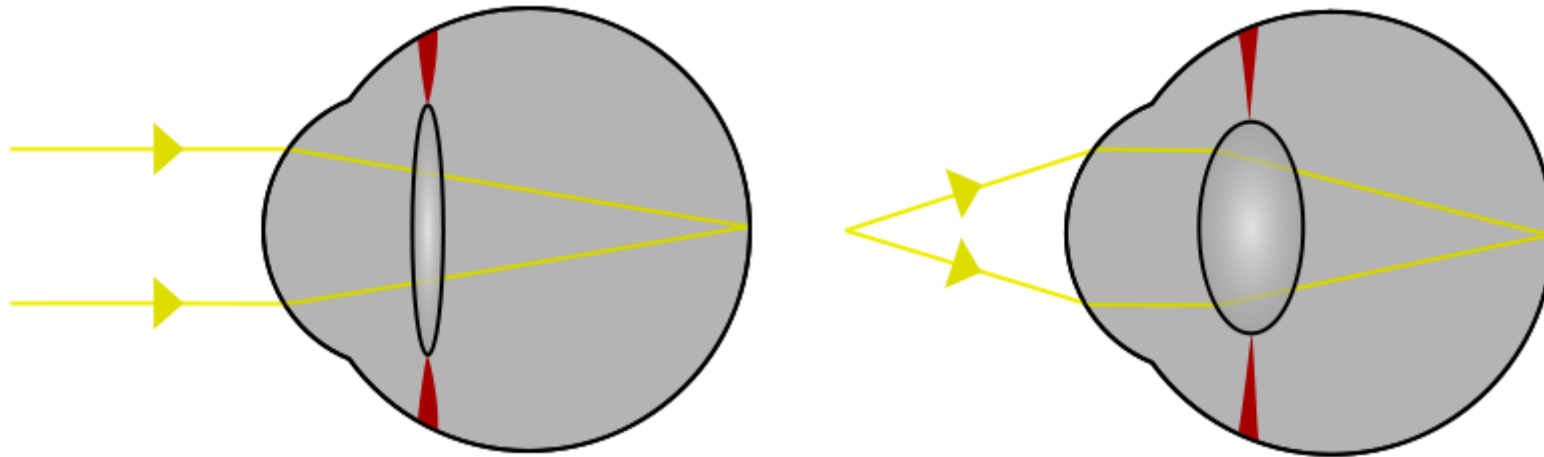

- Automatic focus adjustment by lens deformation
- The adjustment itself works as a depth cue.
 - works at close range.



Depth cue(3) 運動視差 / Motion Parallax



- When we move...
 - Near: Moves in the opposite direction.
 - Far: Does not move, or moves in the same direction.



Depth cue(4)輻輳／Vergence eye movement

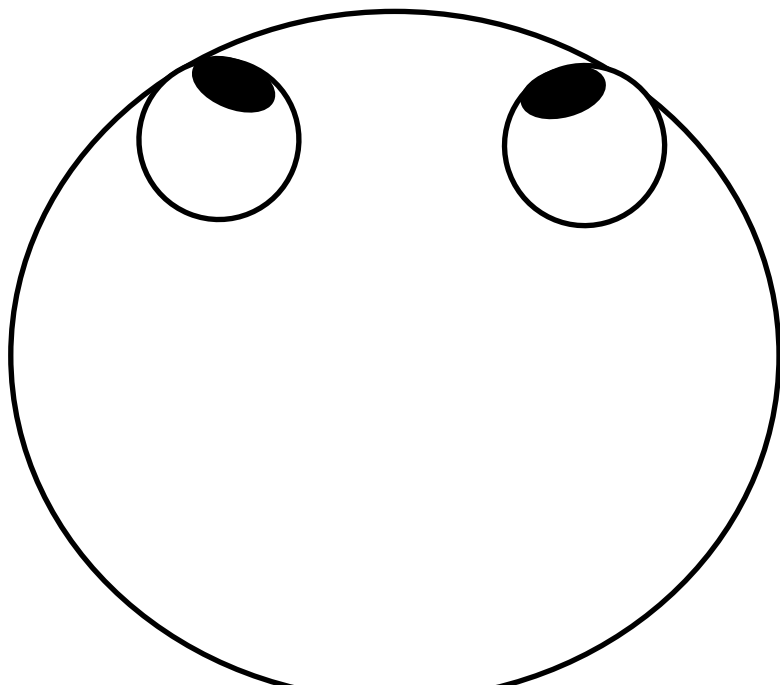

- The eyes converge (move inward) and diverge (move outward) by distance.



輻輳 - 調節矛盾の問題

Vergence-accommodation conflicts

- Accommodation & vergence are slightly coupled.
 - Stereo display problem:
 - Accommodation = constant
 - Vergence = variable
- ⇒ **Severe Fatigue**

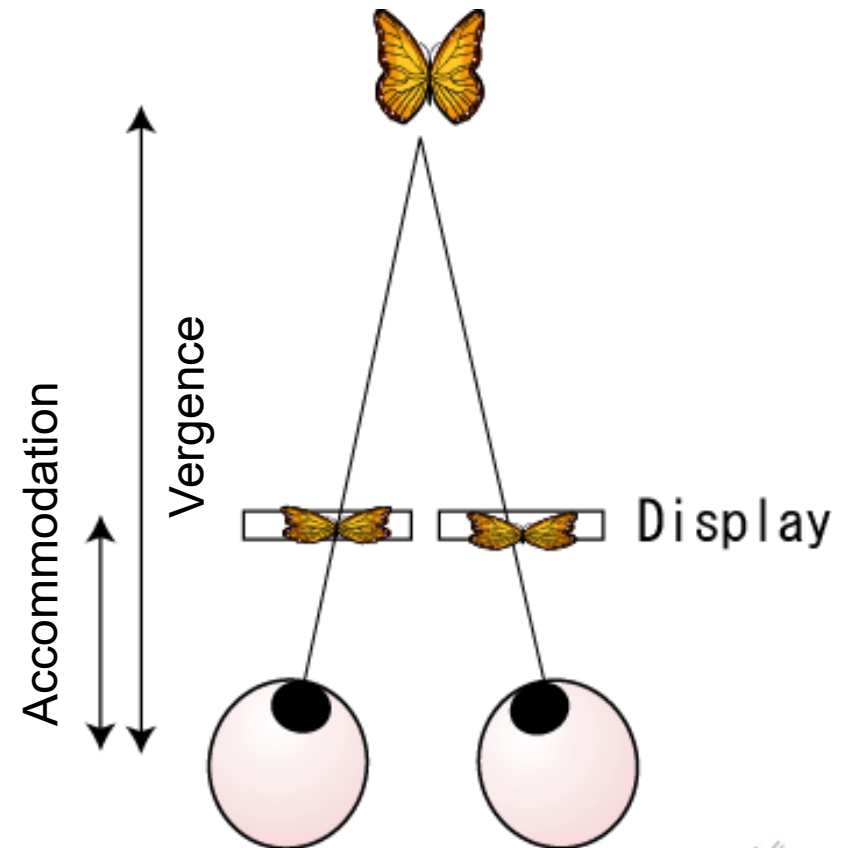
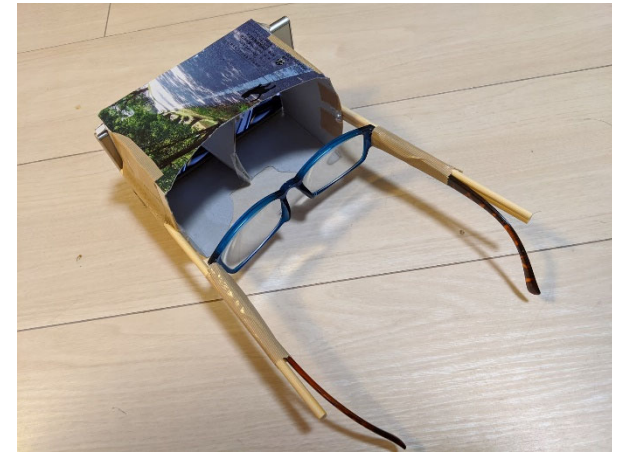

輻輳 - 調節矛盾の許容範囲

Tolerance of vergence-accommodation conflicts

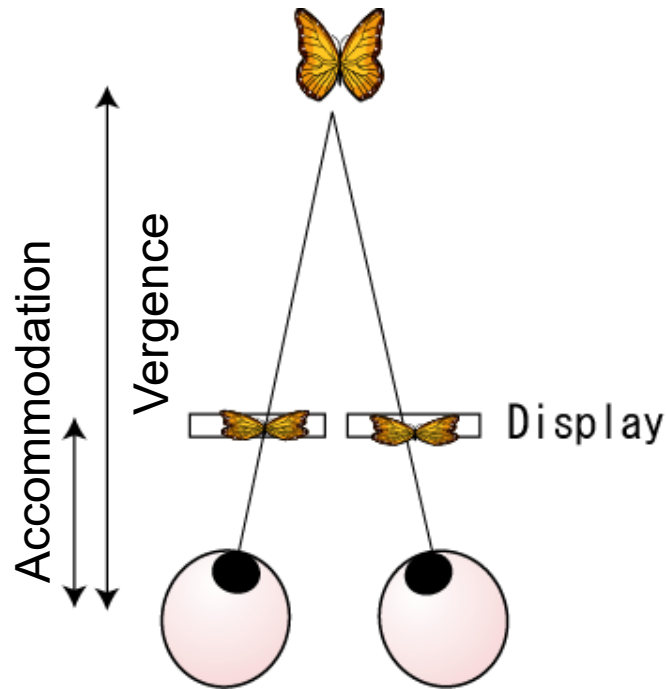

(ex) Physical monitor **0.5m** away from the eyes:

- 0.3m to 1.2m virtual object can be displayed.
- 0.4m to 0.8m virtual object can be **comfortably** displayed.

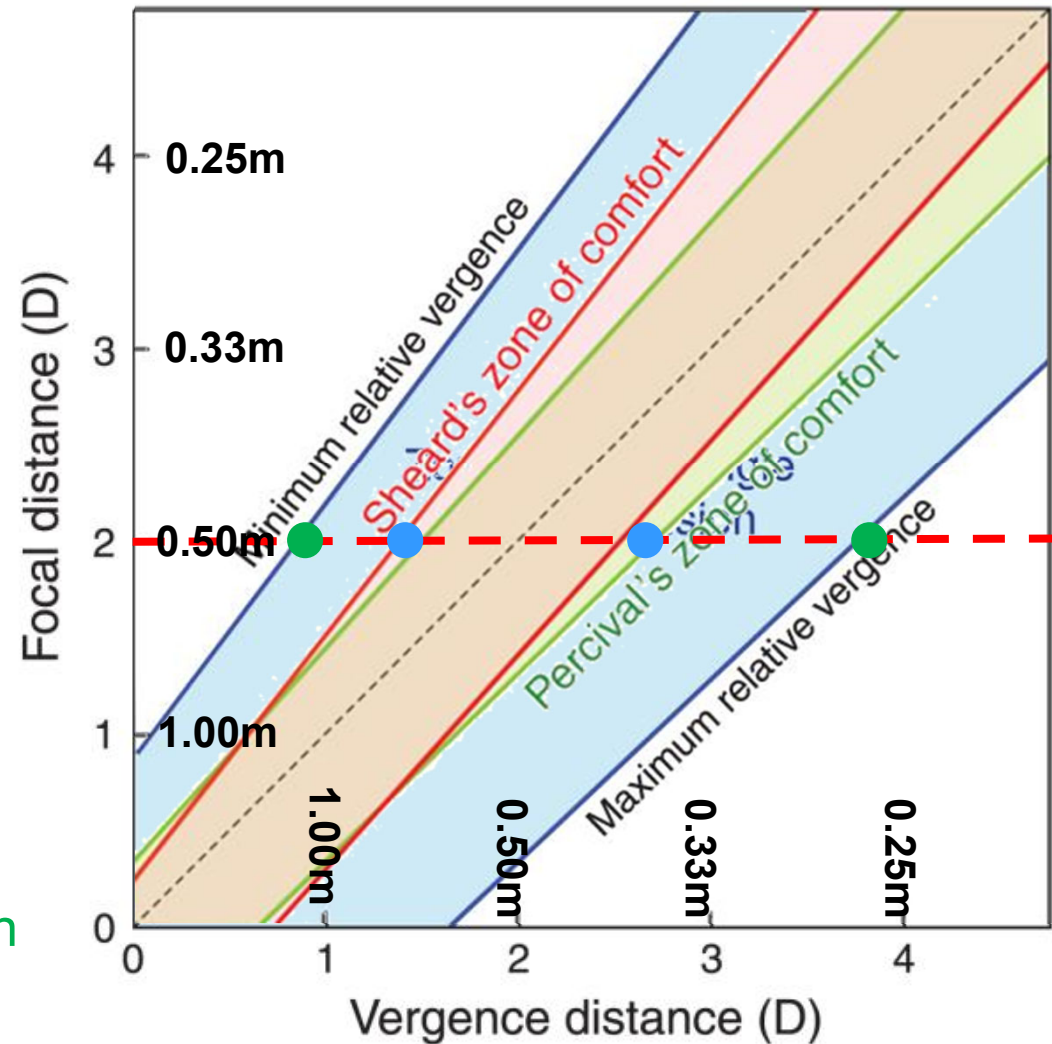

(CHI2016) Novel Optical Configurations for Virtual Reality: Evaluating User Preference and Performance with Focus-tunable and Monovision Near-eye Displays

Robert Konrad, Emily Cooper, Gordon Wetzstein

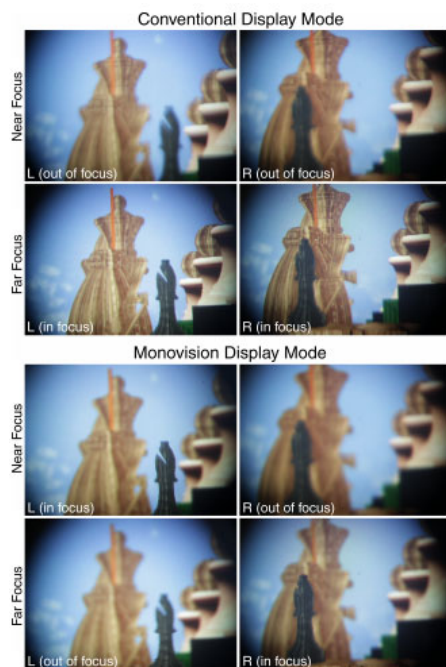

Figure 1. Focus-tunable near-eye display with different rendering modes. In the top panels, we illustrate via photographs how the images seen by each eye in a typical near-eye display are only focused properly when the eyes are focused at a relatively far distance (lower row). When the eyes focus near, to match objects simulated to be near, both eyes' images are blurry (upper row). Monovision is an alternative display mode where the lenses of the two eyes have different focal lengths, allowing for each eye to accommodate at a different distance. The bottom panels illustrate this mode. When the camera is focused relatively far, the left eye's image is out of focus and the right eye's image is sharp (lower row). When the camera is focused near, the relationship reverses. We asked whether this display mode could improve visual comfort and performance.

Novel Optical Configurations for Virtual Reality

Evaluating User Preference and Performance with Focus-tunable and Monovision Near-Eye Displays

Robert Konrad
Stanford University
rkkonrad@stanford.edu

Emily Cooper
Dartmouth College
emilycooper@dartmouth.edu

Gordon Wetzstein
Stanford University
gordon.wetzstein@stanford.edu

<https://www.youtube.com/watch?v=vDkfH6DTxrY>

HMDの輻輳調節矛盾を解決する複数の手法を比較。液体レンズによって焦点距離を動的に変える方法がもっともよい結果だが、monovisionとして知られる、右目と左目をそれぞれ異なる焦点距離にしたもの(老眼への対処として知られる)でも近い結果を得た。

Depth cue(5) 両眼視差／Binocular disparity

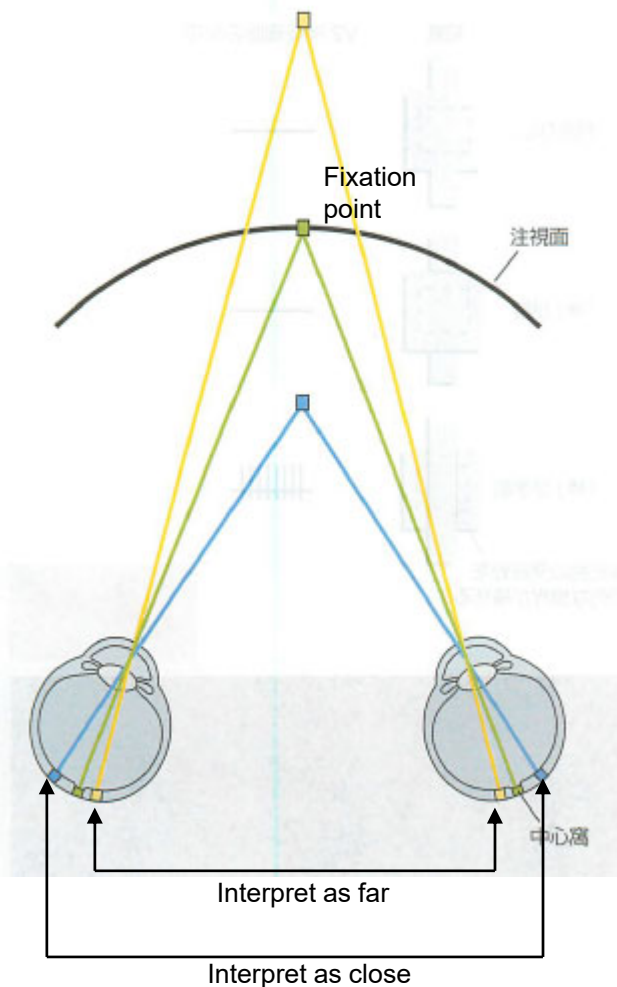

カandel神経科学(Principles of Neural Science)
<https://www.medsj.co.jp/kandel/syousai/index.html>

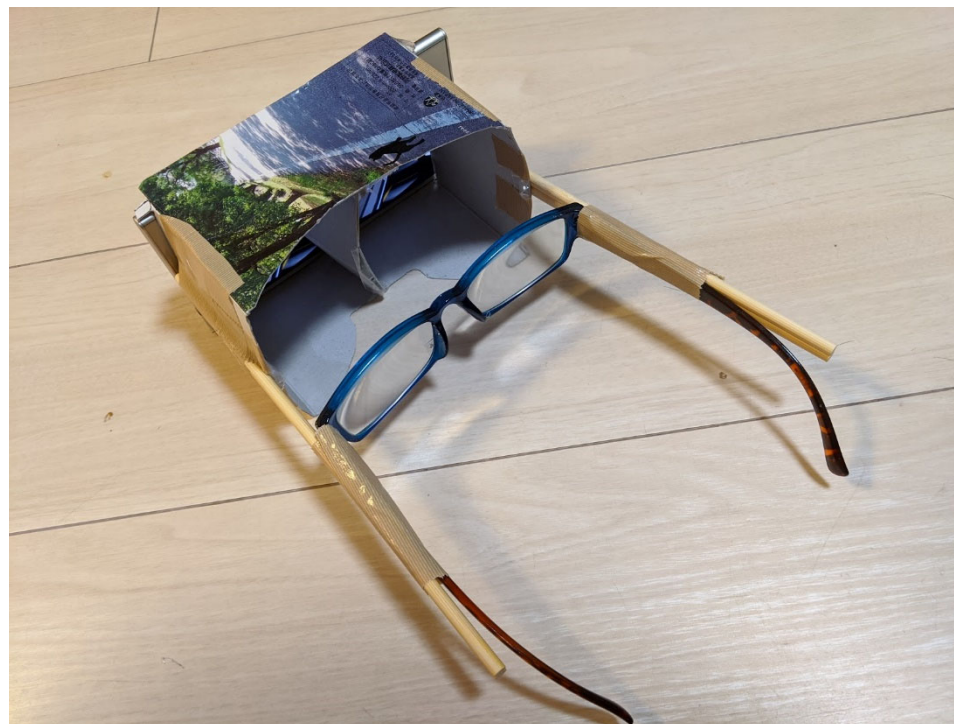

- Disparity = image shift on retina.
 - Vergence: single point.
 - Binocular disparity: whole field of view.



Stereogram



このスライド全体がはがき程度になるよう画面を拡縮し、20cmくらい離れたところから平行法で観察。
Adjust the slide size to about 10cm x 15cm, and watch from 20cm away, R/L eyes to R/L images.

ランダムドット・ステレオグラム

Random dot stereogram (RDS)



<https://gist.github.com/HiroyukiKajimoto/118e810f391d00f51547d9cbda096c7b>

- Proof of “pure disparity can be distance cue”.
Before the RDS, “experience” was thought to play major role.
- Found and used during Vietnam War.

Try Dynamic Random Dot Stereogram (DRDS):

<https://www.youtube.com/watch?v=CRyDXVoYfOM&list=PLA4A975B45148C53A>



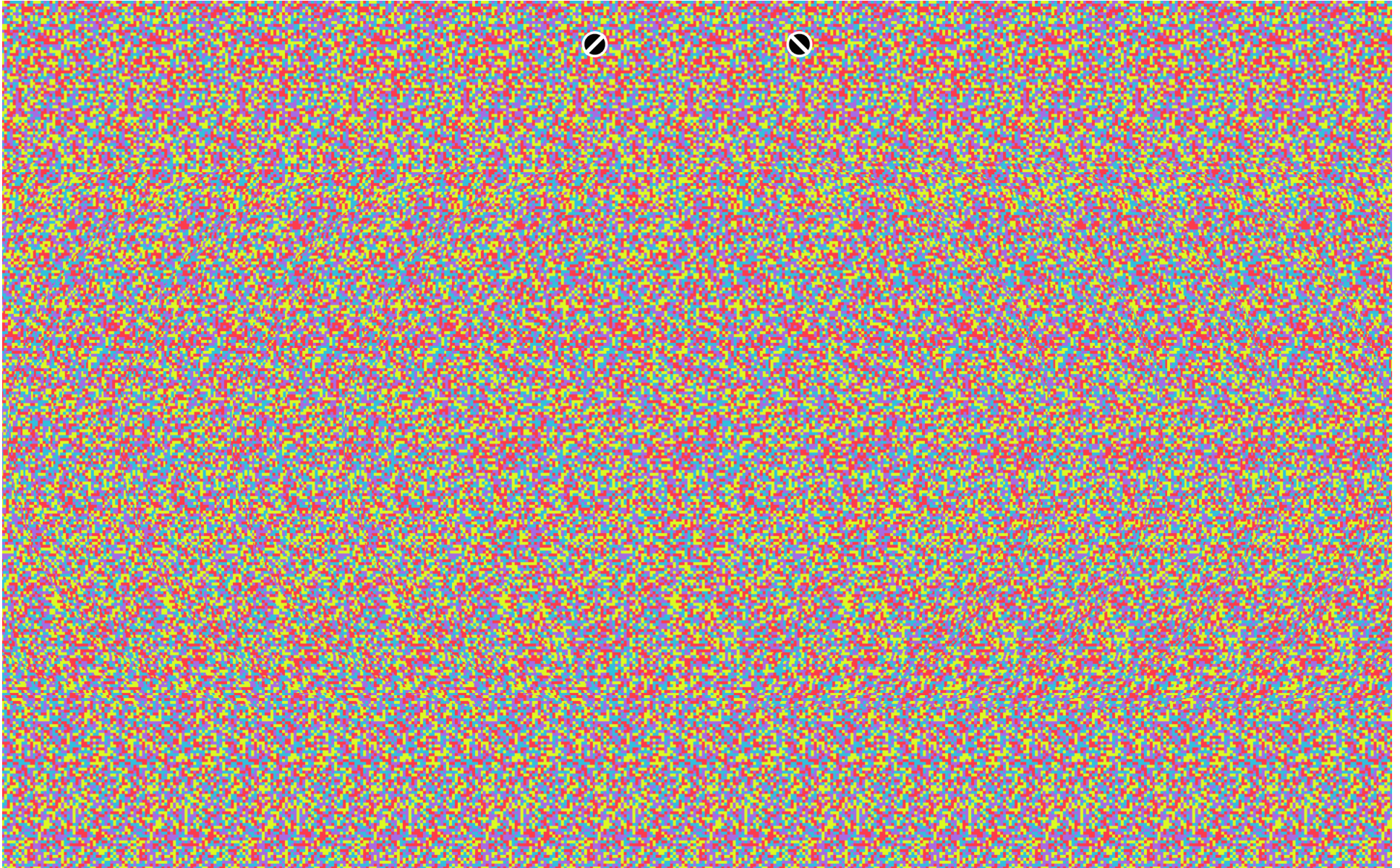

<https://www.lyt.jp/meta/howto.htm>

TODAY'S TOPIC

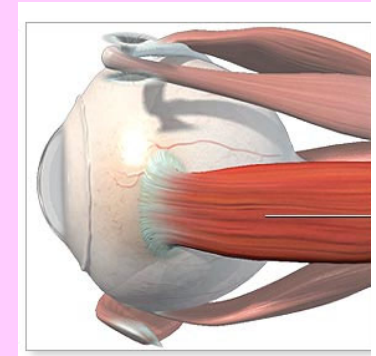
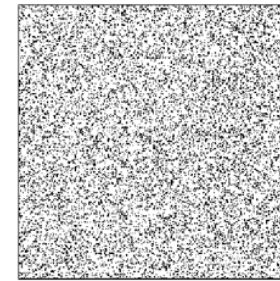
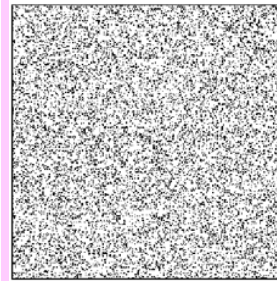
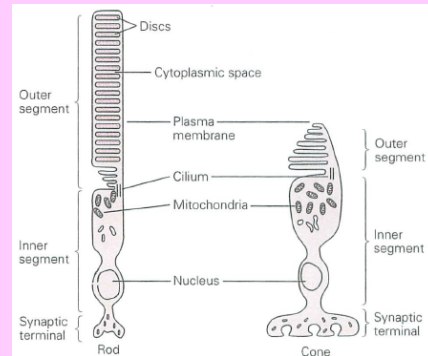
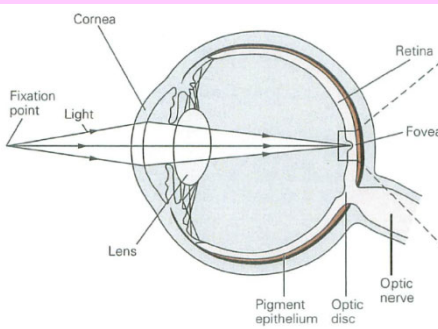

- 目の構造 / Eye structure
- 目のセンサ / Eye sensors
- 奥行き知覚 / Depth perception
- 眼球運動 / Eye movement



Eye movement

A 側面からみた図

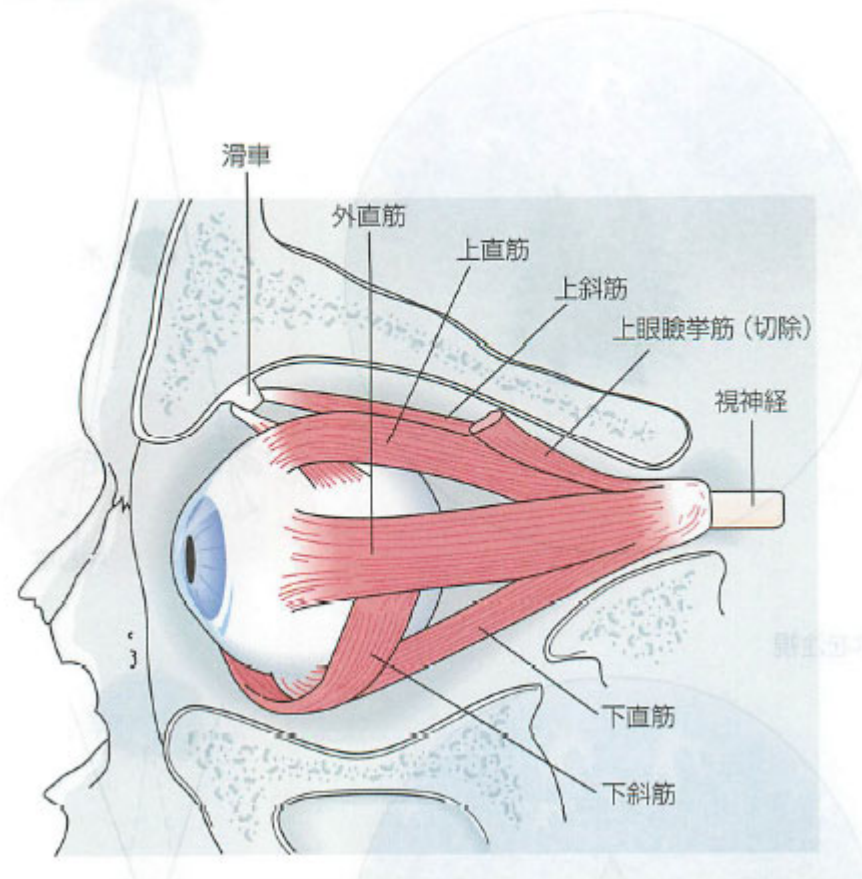

B 上方からみた図

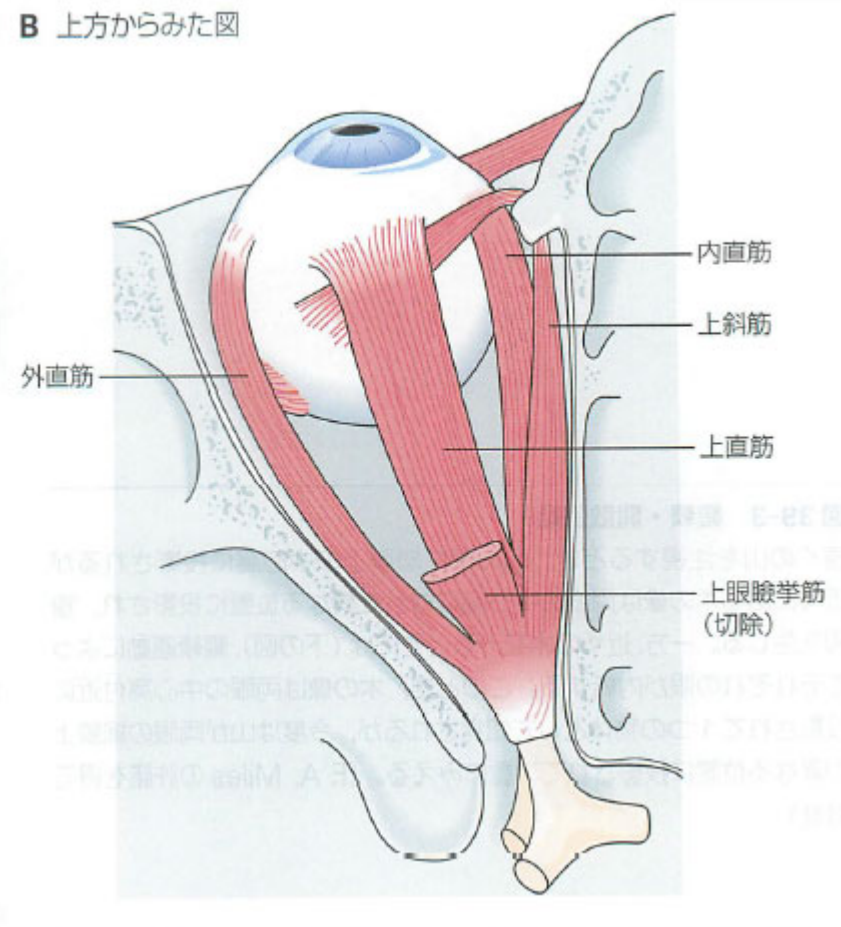

- 6 muscles (3 pairs) rotate eyes.

Eye movement: 解析手段・入力手段として / For Analysis and as an Interface



<https://www.amazon.co.jp/dp/B079T13PZK>

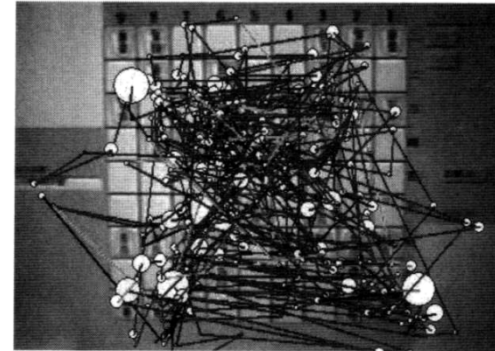

初級者の視線の動き

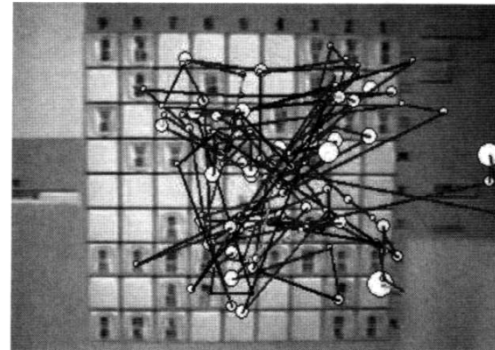

中級者の視線の動き

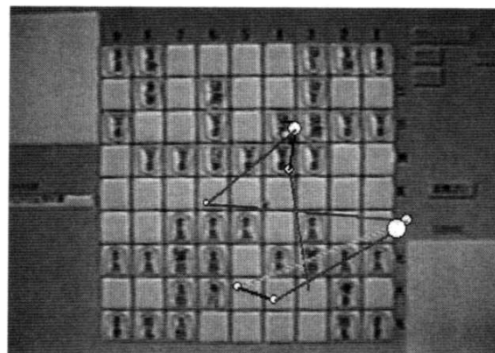

羽生さんの視線の動き



(CHI2016) EyeSwipe: Dwell-free Text Entry Using Gaze Paths

Andrew T. N. Kurauchi, Wenxin Feng, Aijen D. Joshi, Carlos H. Morimoto, Margrit Betke

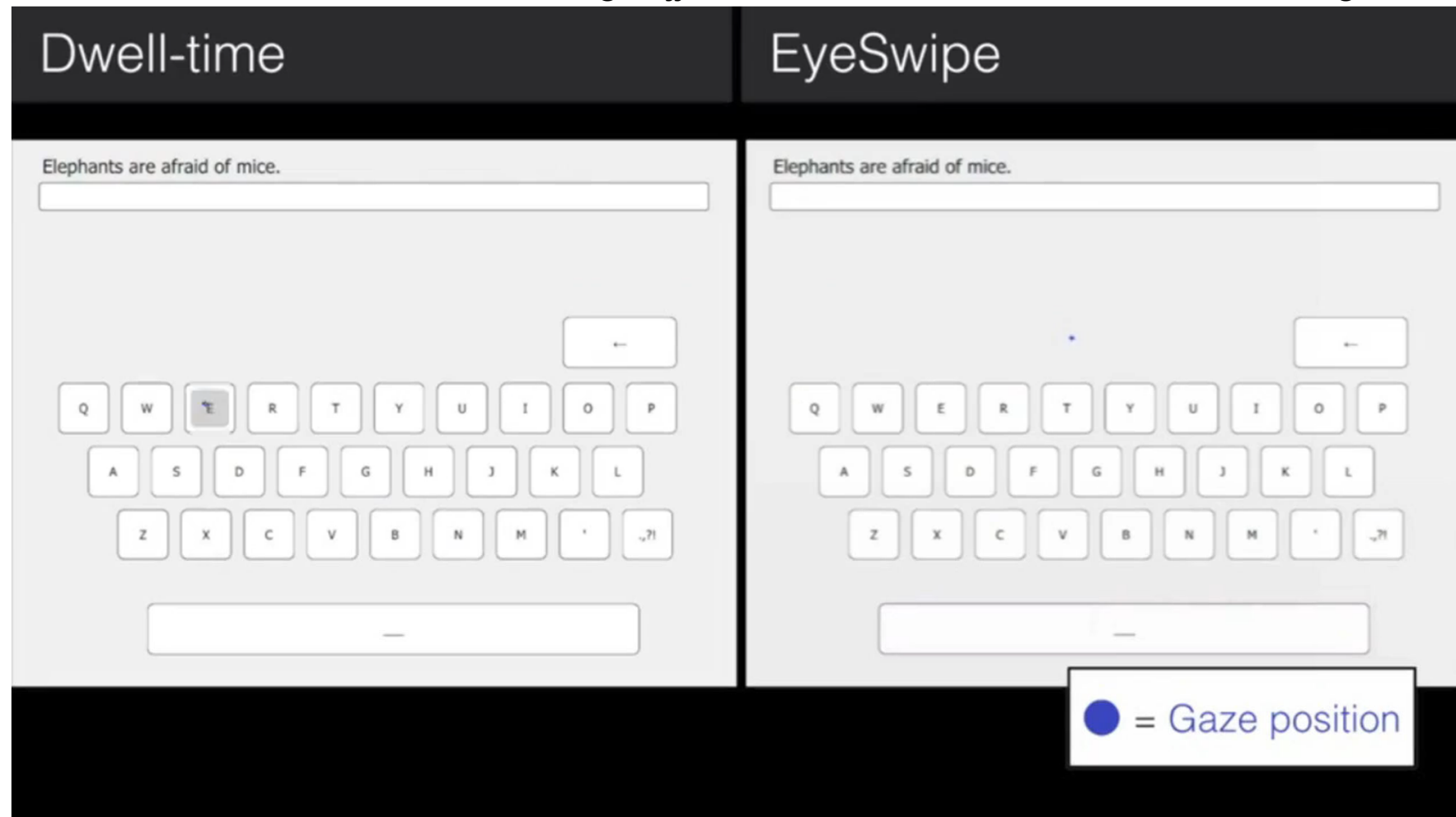

<https://www.youtube.com/watch?v=QpghYJwTMuc>

眼球運動によるキーボード入力. 単語の最初と最後の文字はしっかりと見る. 途中の文字は近傍をかするように見る. あとは登録単語辞書を使う



その他の「眼」まわりのインタフェース

Other interfaces around the eye: blinking

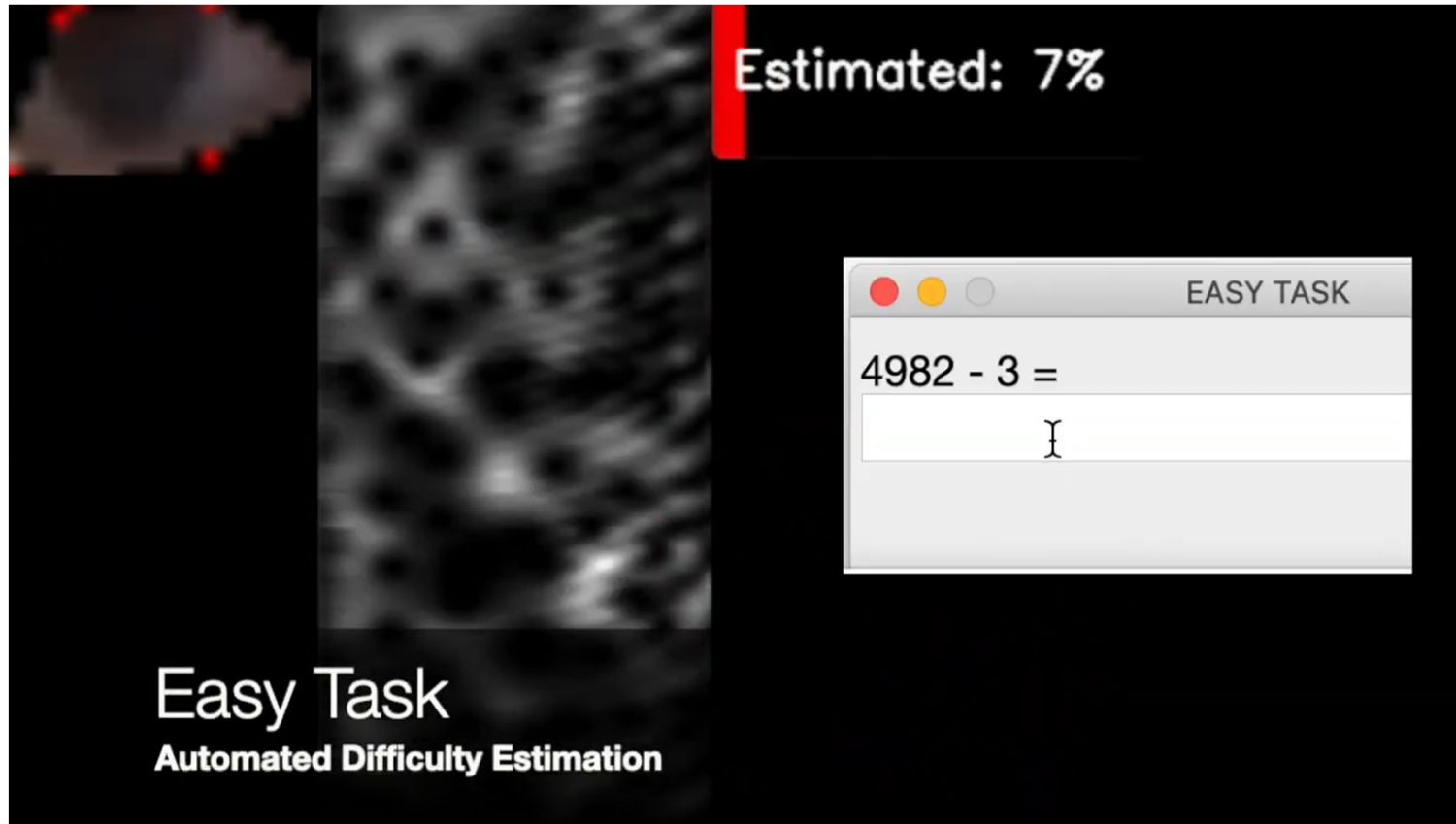

(CHI2021) Rethinking Eye-blink: Assessing Task Difficulty through Physiological Representation of Spontaneous Blinking Youngjun Cho

<https://www.youtube.com/watch?v=O8LsUmQD4hM&list=PLqhXYFYmZ-Vdsg4-okDWnptnyAs8HXjfN&index=199>

- 目の瞬きを計測すると行っているタスクの難易度がわかる。
- Measuring the blink of the eye indicates the difficulty of the task being performed.

(CHI2022)"Your Eyes Say You Have Used This Password Before": Identifying Password Reuse from Gaze Behavior and Keystroke Dynamics Yasmeeen Abdrabou, Johannes Schütte, Ahmed Shams, Ken Pfeuffer, Daniel Buschek, Mohamed Khamis, Florian Alt

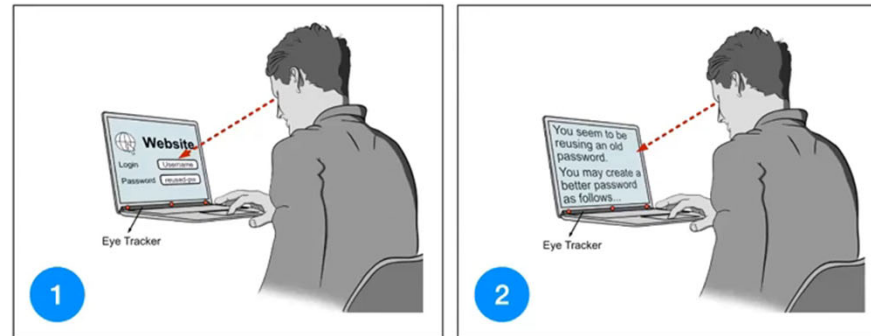

"Your Eyes Tell You Have Used This Password Before": Identifying Password Reuse from Gaze and Keystroke Dynamics

Yasmeeen Abdrabou, Johannes Schütte, Ahmed Shams, Ken Pfeuffer, Daniel Buschek, Mohamed Khamis, Florian Alt



パスワード入力時の眼球運動計測で、そのパスワードを使ったことがあることを判定
Measurement of eye movement when entering a password to determine that the password has been used before.

https://www.youtube.com/watch?v=u_NhFcmVThY&list=PLqhXYFYmZ-VcAoFsLTdH9hF26jsFkvs2B&index=183

(UIST2022) DEEP: 3D Gaze Pointing in Virtual Reality Leveraging Eyelid Movement
Xin Yi, Leping Qiu, Wenjing Tang, Yehan Fan, Hewu Li, Yuanchun Shi

DEEP

3D Gaze Pointing in Virtual Reality Leveraging Eyelid Movement

Xin Yi¹ Leping Qiu¹ Wenjing Tang² Yehan Fan³ Hewu Li¹ Yuanchun Shi¹

¹Tsinghua University

²Southeast University

³Beijing University of Posts and Telecommunications



<https://www.youtube.com/watch?v=ITz8SN7s7SY&list=PLqhXYFYmZ-VdaPIMTFVH5K5brMDJClfAn&index=87>

意識的、無意識的な瞼(まぶた)の動きをターゲットセレクションに利用する。
Conscious and unconscious eyelid movements are used for target selection.

How to measure **Eye** movement

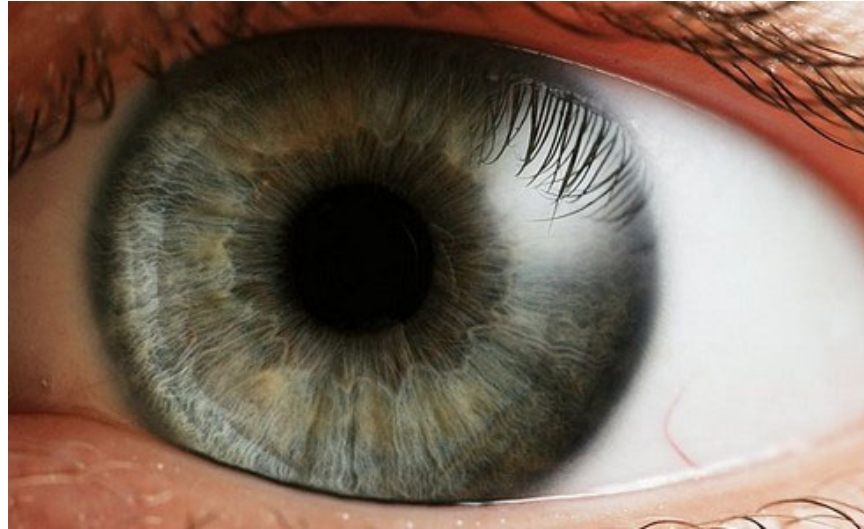

- アナログ測定 / Analog measurement
 - コンタクトレンズ / Contact Lens
 - 眼底電位 / Electrooculography
 - 強膜反射 / Limbus Tracking Method
- 画像処理 / Computer Vision
 - パッシブ・アクティブな方法 / Passive・Active Methods



カイモグラフ / Kymograph

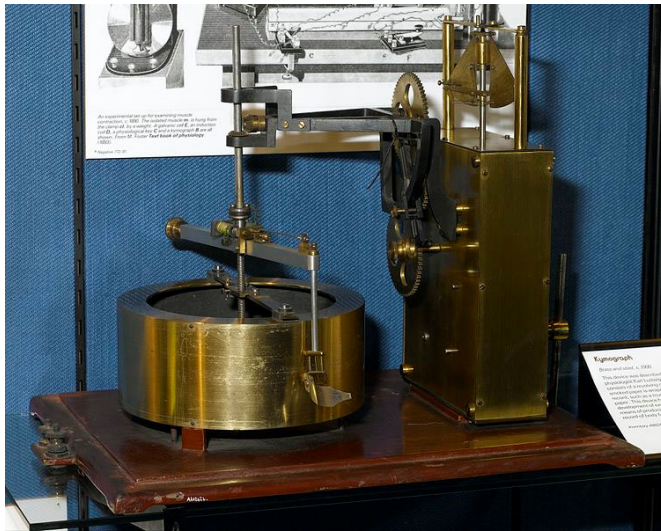

<https://wellcomeimages.org/indexplus/image/L0057897.html>

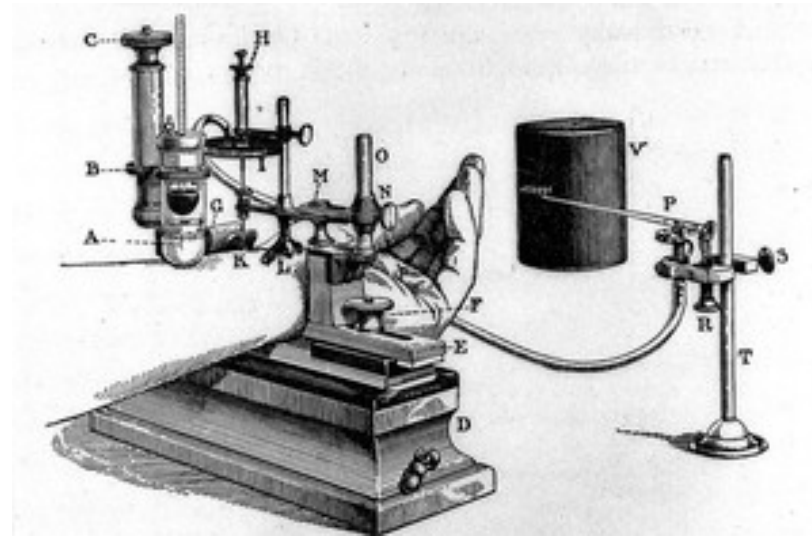

<https://wellcomecollection.org/works/fzn6j26r>

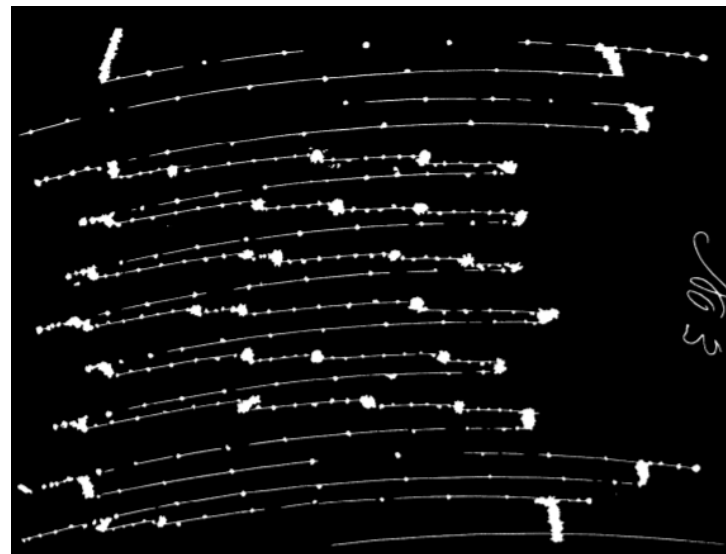
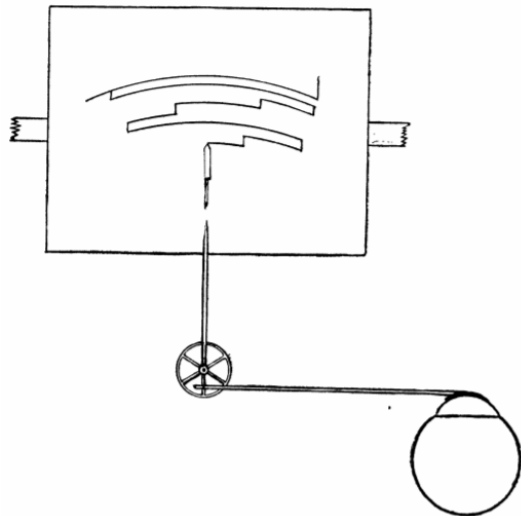

- Huey E B. "Preliminary experiments in the physiology and psychology of Reading" American Journal of Psychology. 1898;9:575-586.
- Huey E B. "On the psychology and physiology of reading. I" American Journal of Psychology. 1900;11:283-302.

- Recorded horizontal movement of the eye while reading.



コンタクトレンズ / Contact Lens

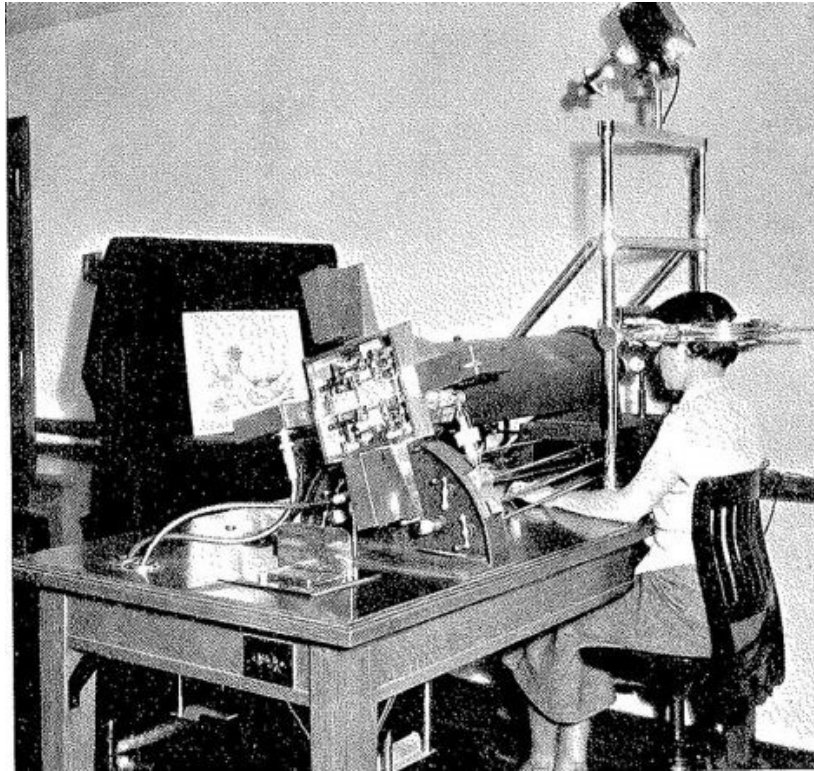

<https://medium.com/@eyesee/eye-tracking-through-history-b2e5c7029443>

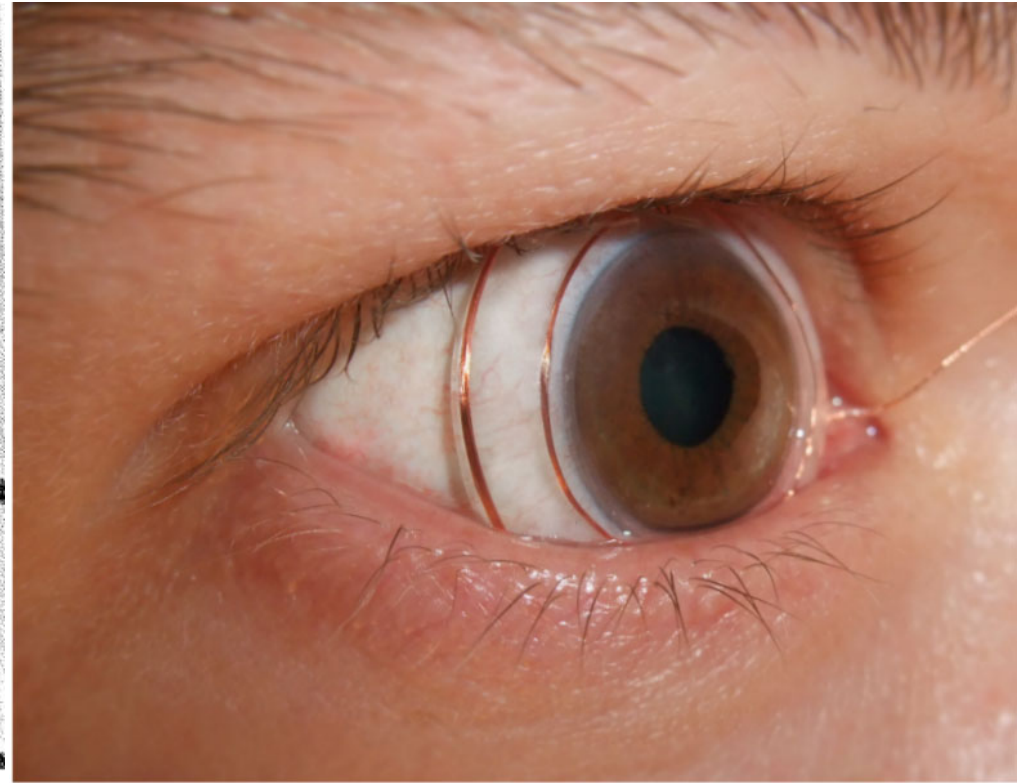

https://www.chronos-vision.de/downloads/CV_Product_SSC.pdf

- オプティカル・レバー法: コンタクトレンズに微小ミラー装着
Optical lever method using micro-mirror attached on contact lens.
- サーチコイル法: コンタクトレンズにコイルを埋込
Search coil method using coil embedded in contact lens.



(ISWC '16) Eric Whitmire et al. :EyeContact: Scleral Coil Eye Tracking for Virtual Reality



The image is a composite of four parts. Top left: A photograph of a small, dark-colored, four-wheeled robotic car with red wheels and red wires, set against a white background. Top right: A photograph of a person wearing a black VR headset with four circular scleral coils attached to the front. Bottom left: The text 'EyeContact Scleral Coil Tracking for Virtual Reality' and the authors' names. Bottom right: A diagram of a scleral coil with a 'Primary Coil' and a 'Torsion Coil', showing magnetic moments M_p and M_t .

ubiocomplab
UNIVERSITY OF WASHINGTON

EyeContact

Scleral Coil Tracking for Virtual Reality

Eric Whitmire, Laura Trutoiu, Robert Cavin, David Perek, Brian Scally, James O. Phillips, Shwetak Patel

Primary Coil
Torsion Coil
 M_p
 M_t

<https://www.youtube.com/watch?v=R8DG0aIZymg>

http://www.cs.cmu.edu/~ltrutoiu/pdfs/ISWC_2016_trutoiu.pdf

Search coil method is embedded in HMD to achieve much higher tracking accuracy.



眼底電位 Electrooculography, EOG

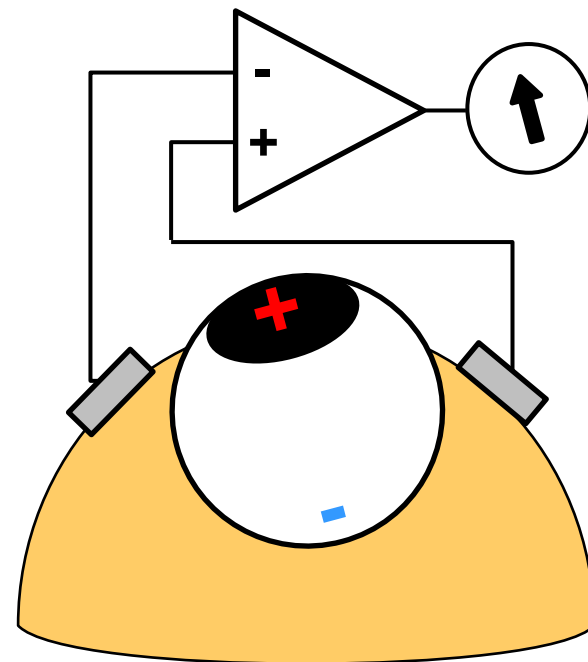
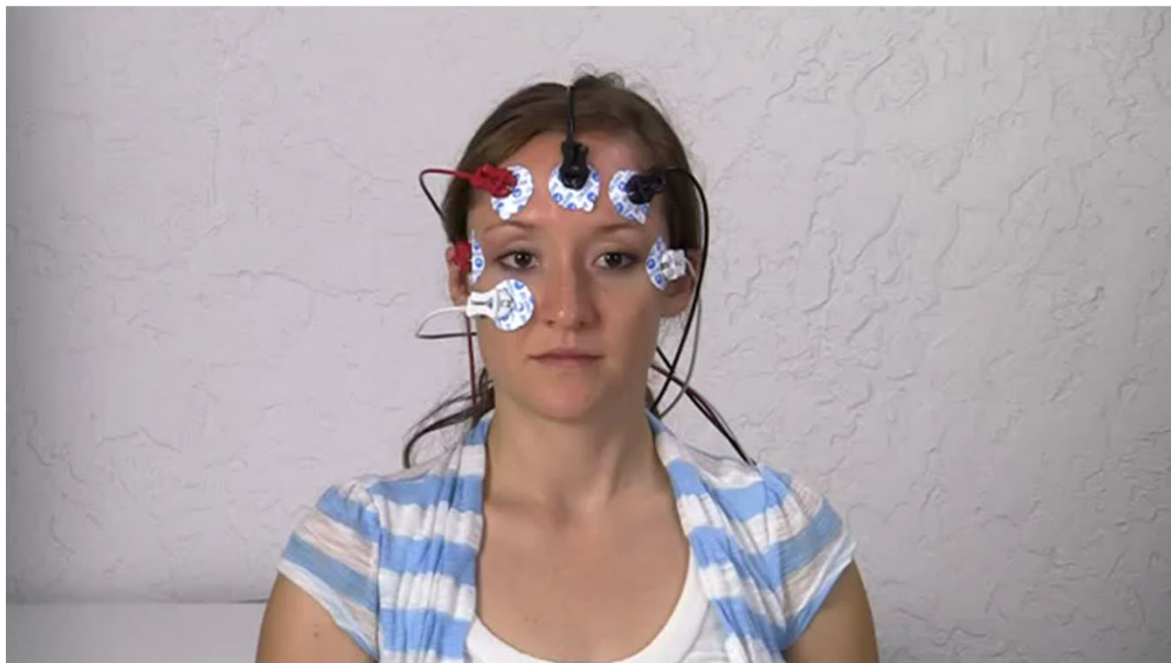

- <https://www.youtube.com/watch?v=-QXGiZBDkUw>
- Horny coat(角膜) has ~1mV positive voltage to Retina(網膜)
- Electrodes(電極) around eyes.
⇒ Measured voltage is proportional to eye rotation.
- Has wide range (velocity, frequency)
- Accuracy not so good (1 deg~)
- Might be good method for HMD?



JINS MEME <https://jinsmeme.com/>

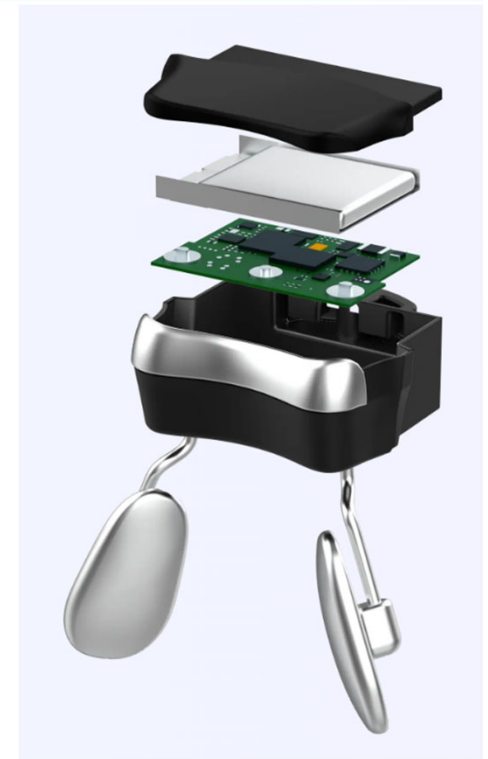

- 鼻あて部分の3点の電極による眼底電位計測＋6軸センサ（従来のメガネ型眼低電位計測の多くはツルと鼻あてを利用）
- EOG measurement using 3 electrodes on the nosepiece. (Most conventional eyeglass-type EOG measurements use the temple and nosepiece)
- <https://pc.watch.impress.co.jp/docs/news/648078.html>

強膜反射 / Limbus Tracking Method

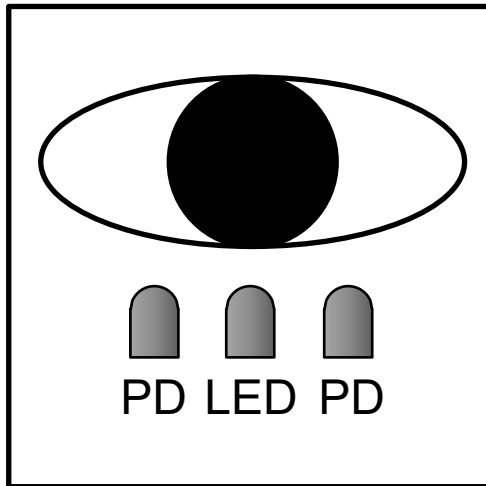

Spectacle unit
(Limbs tracker, camera)

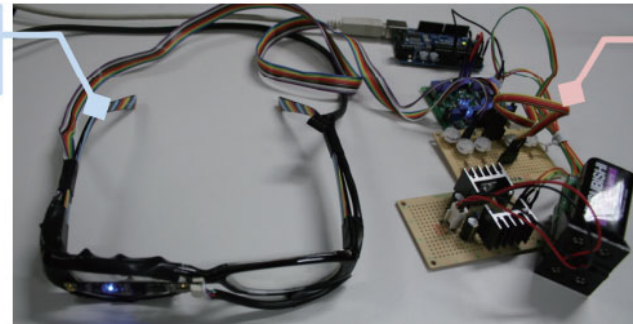

Processing unit
(Power source, Amp, MPU)



<https://lab.rekimoto.org/projects/aidedeyes/>

<https://vimeo.com/10351085>

Yoshio Ishiguro, Adiyana Mujibiya, Takashi Miyaki, Jun Rekimoto: Aided Eyes: Eye Activity Sensing for Daily Life (AH2010)

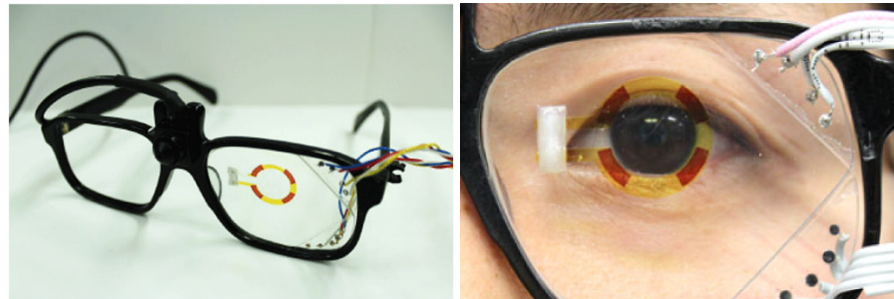

<http://www.miki.mech.keio.ac.jp/researchdetail/humaninterface/eyetracking/>

M. Ozawa, K. Sampei, C. Cortes, M. Ogawa, A. Oikawa, and N. Miki, "Wearable line-of-sight detection system using micro-fabricated transparent optical sensors on eyeglasses" Sensors and Actuators A: Physical, vol. 205, pp. 208-214, 2014.

- Emit IR light to the eye, measure reflected light.
黒目と白目の境界に赤外線照射。反射光計測
- Received light: White part > Black part.
- Good for horizontal eye motion. Easy to make.



Computer Vision

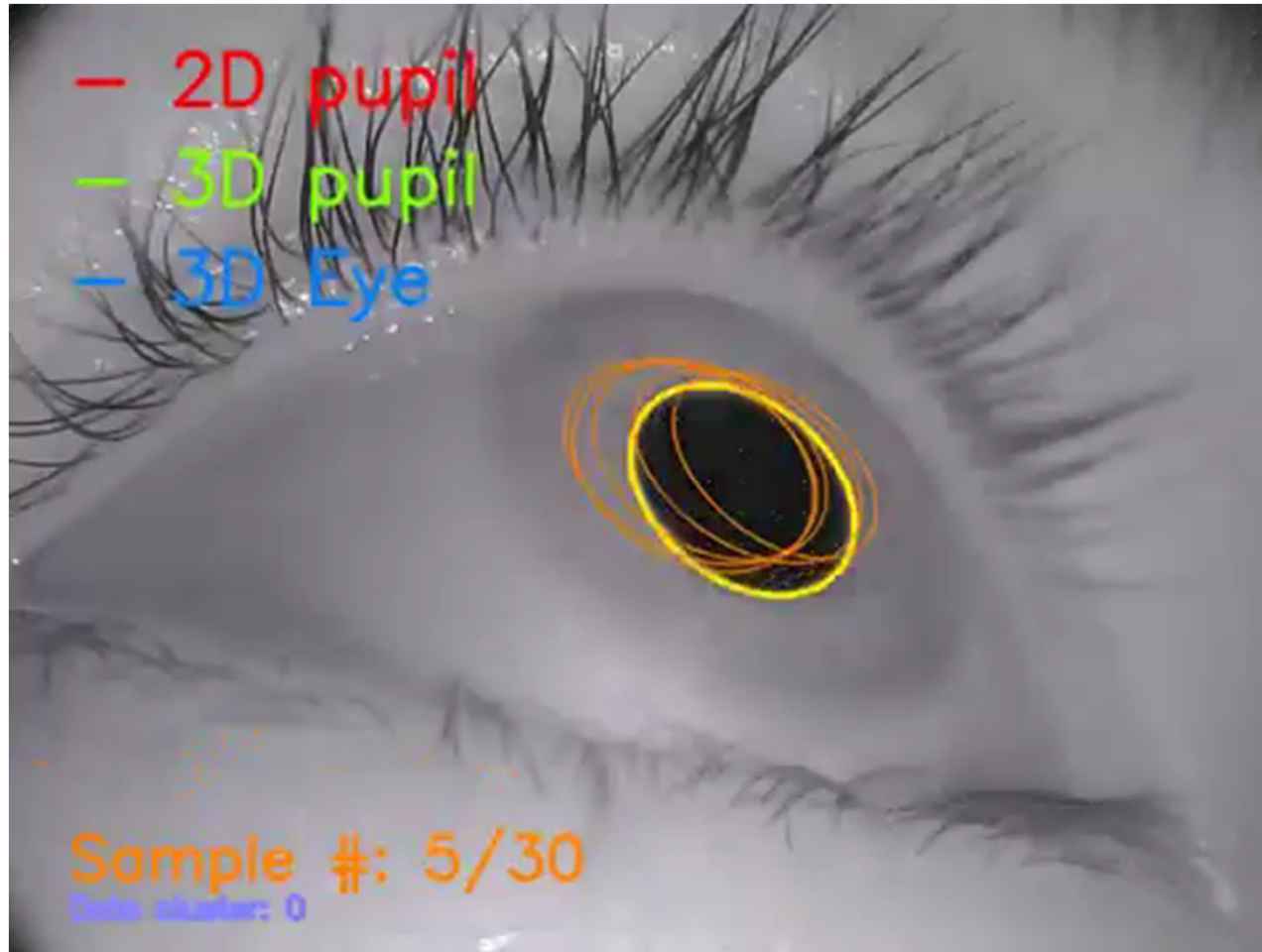

<https://www.youtube.com/watch?v=EH6UVQZgvJE>

- Capture eye image.
- By image processing (pattern matching), eye center is calculated.
- Refresh rate = video rate.



角膜反射／Reflection at Horny Coat

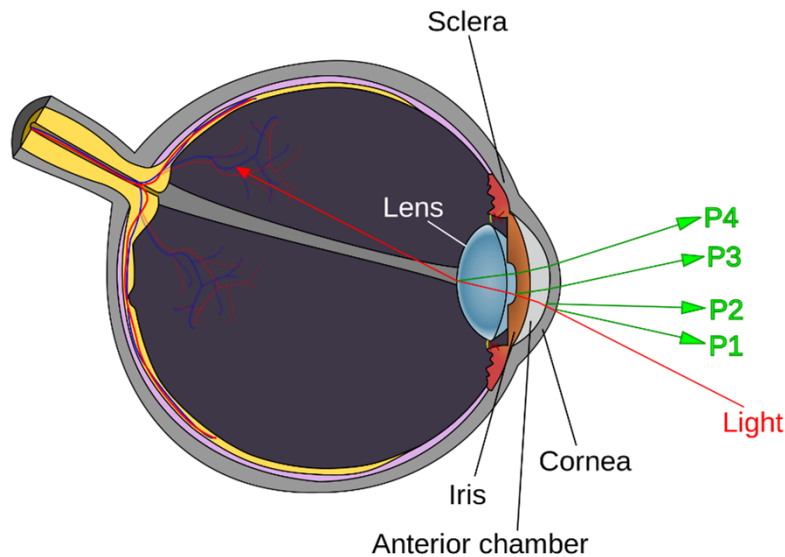

Purkinje images (Wikipedia)
https://en.wikipedia.org/wiki/Purkinje_images



<https://www.youtube.com/watch?v=RIhjd5rFANk>

- When illuminated with point light source, the horny coat gives typical reflectance image (Purkinje image), which can be used to monitor relative eye movement.
- 点光源の角膜照射時に現れる角膜反射像(プルキニエ像)から眼球運動を計測
- ビデオカメラで撮影⇒画像処理し、瞳孔中心との相対位置を取得できる。



(発展)角膜反射像による環境情報取得 / Using reflection image at horny coat for environment recognition

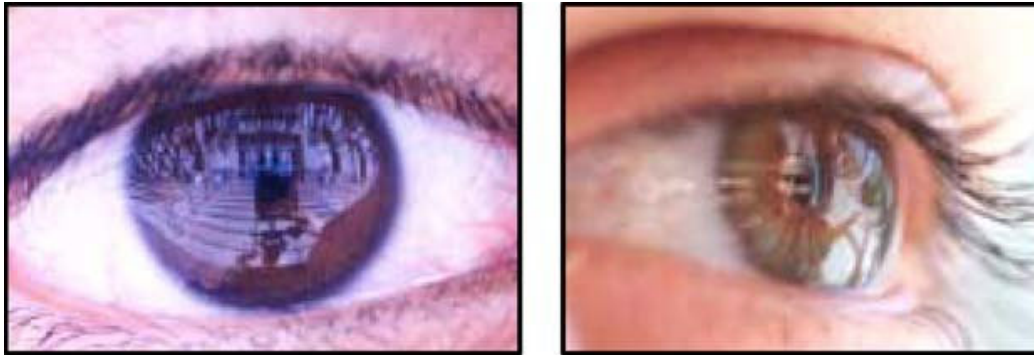

K. Nishino, S. K. Nayar: Corneal Imaging System:
Environment from Eyes, Int. J. Computer Vision 2006.



図1 角膜イメージング法によって得られたシーンの光線マップ
左：角膜反射画像 中央：光線マップ 右：シーン画像

中澤篤志:角膜イメージング法による視覚推定とその将来展望
https://www.jstage.jst.go.jp/article/tits/20/9/20_9_89/_pdf-char/ja

BBC Sign in News Sport Reel Worklife Travel Future Mc
NEWS
Home Video World Asia UK Business Tech Science Stories Entertainment &
Asia China India
Stalker 'found Japanese singer through reflection in her eyes'
© 10 October 2019 f t Share
Police say the stalker was able to locate his victim by zooming in on the reflection in her eyes

A Japanese man accused of stalking and sexually assaulting a young pop star told police he located her through the reflection in her eyes in a picture, according to local media reports.

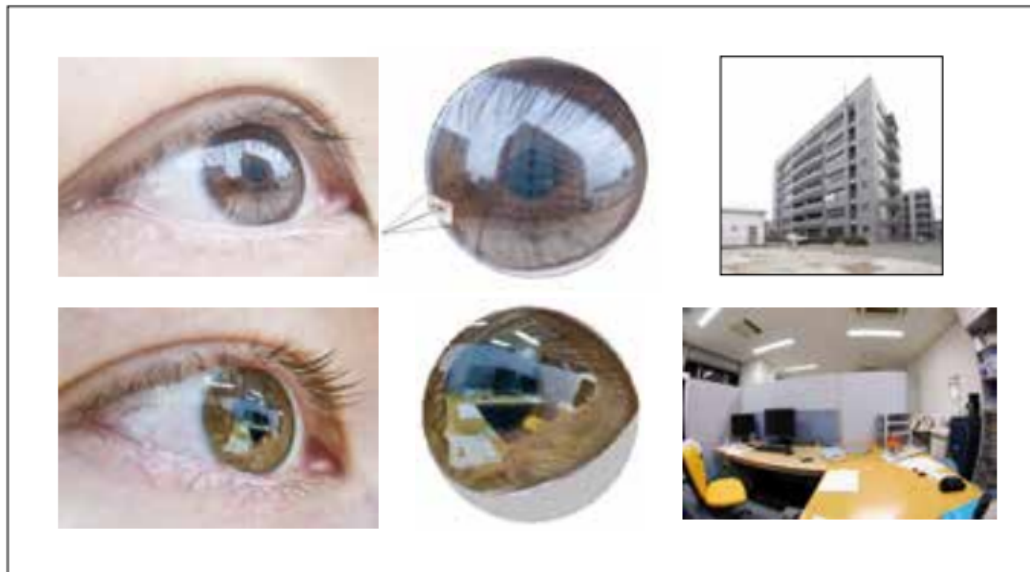
<https://www.bbc.com/news/world-asia-50000234>

(CHI2022) ReflecTouch: Detecting Grasp Posture of Smartphone Using Corneal Reflection Images

Xiang Zhang, Kaori Ikematsu, Kunihiro Kato, Yuta Sugiura

ReflecTouch: Detecting Grasp Posture of Smartphone Using Corneal Reflection Images

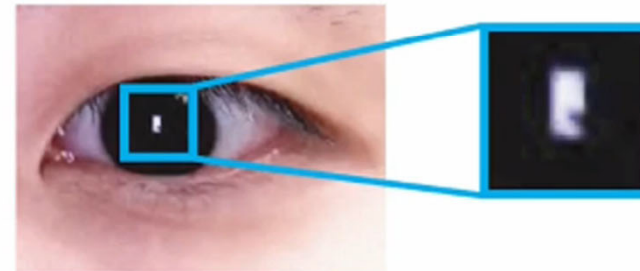

Xiang Zhang¹⁾, Kaori Ikematsu²⁾, Kunihiro Kato³⁾, Yuta Sugiura¹⁾
¹⁾Keio University, ²⁾Yahoo Japan Corporation, ³⁾Tokyo University of Technology

<https://www.youtube.com/watch?v=RTW3CeWke8w&list=PLqhXYFYmZ-VcAoFsLTdH9hF26jsFkvs2B&index=336>

スマートフォンのカメラで眼球の角膜反射像を撮影。そこからスマートフォンを握っている手の状態を推定

A corneal reflection image of the eyeball is captured by the camera of a smartphone. The state of the hand holding the smartphone is estimated from this image.

赤目現象の利用／Red-eye Effect



Red eye effect (Wikipedia)

https://en.wikipedia.org/wiki/Red-eye_effect

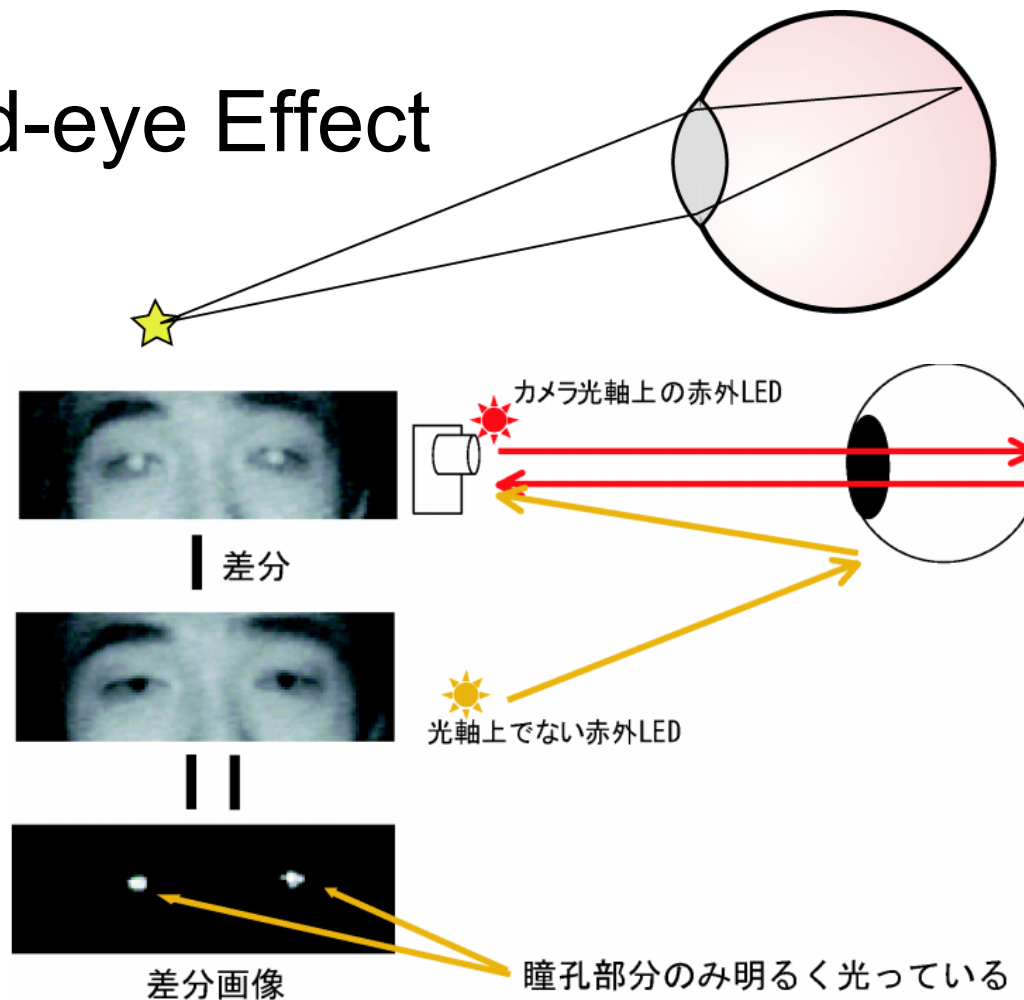

渡邊他: 網膜再帰反射を利用した遠隔サッカー検出手法の研究、TVRSJ2004.

https://www.jstage.jst.go.jp/article/tvrsj/9/1/9_KJ00007553951/_pdf

- 目のレンズによる再帰性反射で網膜の色(血管)が反射する現象. 光源に戻る
- 光源を2種類(同軸上か否か)用意すれば差分画像として瞳孔だけ検出可能
- Red-eye effect (=retroreflection by eye lens) can be used to extract eye pupils by taking two pictures; one with concentric light and one with surrounding light.

<https://dailyportalz.jp/kiji/140317163585>



眼球運動の種類／Eye movements

- スムーズパースート(滑動性眼球運動)
Smooth Pursuit
 - Follow slow movement of small dots.
Voluntary (conscious)
- サッケード(跳躍性(衝動性)眼球運動)
Saccade
Stepwise movement
 - Motion start is voluntary and involuntary.
 - During motion,
 - You cannot stop (involuntary)
 - Visual acuity drops.
- 固視微動
Miniature eye movement
 - Very small vibration. 30~100Hz.
 - Refresh the image on the retina.
 - Anesthetization of muscles⇒No visual image.

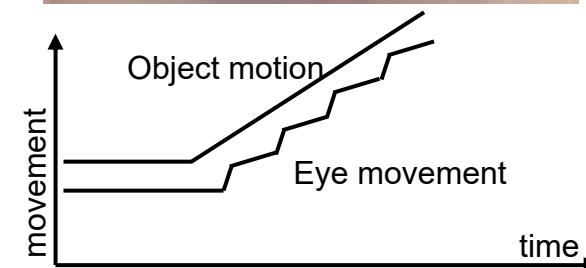
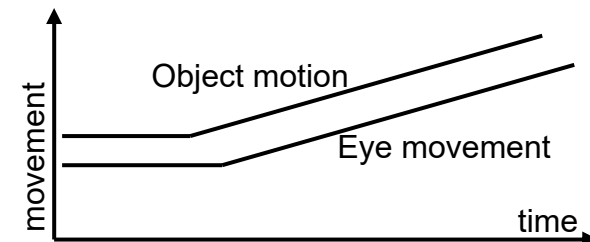

眼球運動の種類 / Eye movements



Smooth Pursuit



Saccade



安定化のための反射としての眼球運動

Eye movement for stabilization

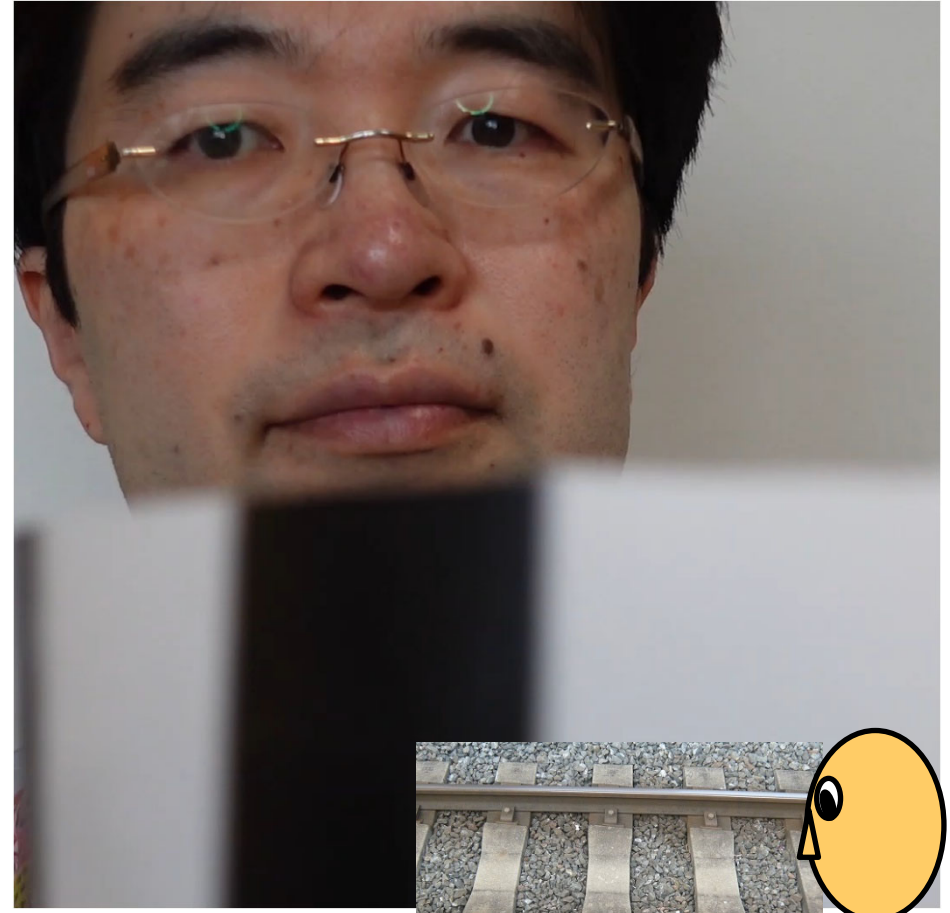
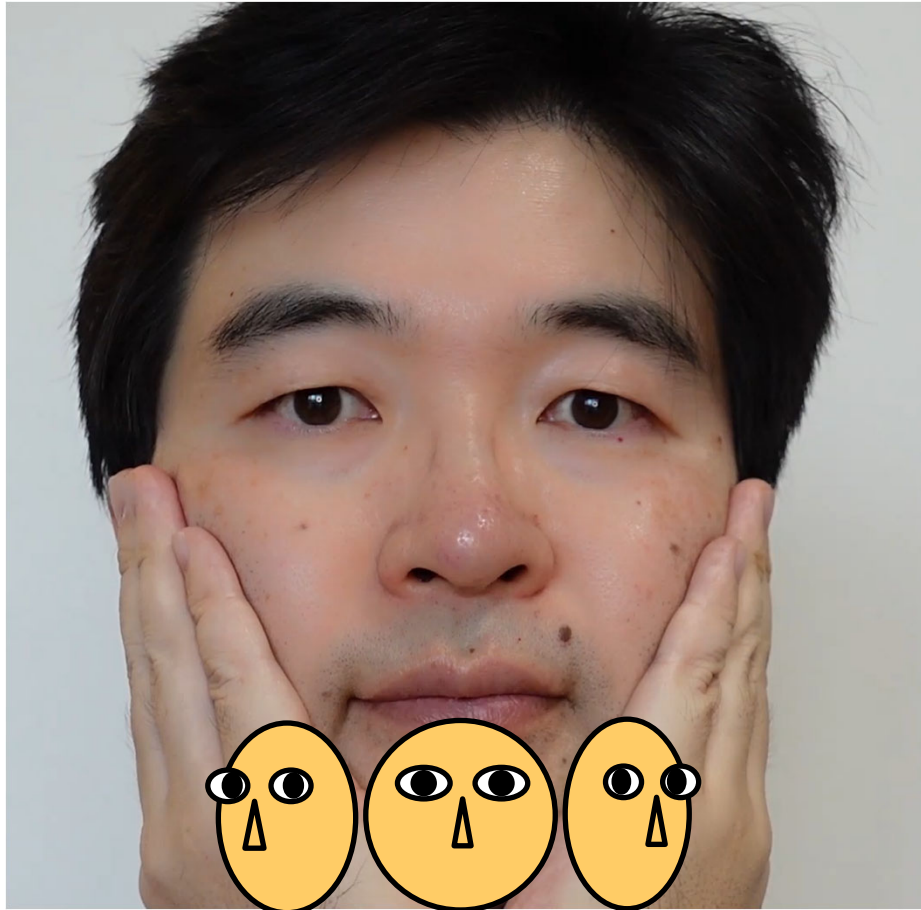

- 前庭動眼反射／Vestibulo-ocular reflex(VOR)
 - Cancels head rotation.
- 視運動性眼球運動／Optokinetic Response(OKR)
 - When the whole visual field moves, the eye follows.



参考: Chicken Head Tracking - Smarter Every Day



http://www.youtube.com/watch?v=_dPIkFPowCc



参考:カナヘビ Reptile



TODAY'S SUMMARY

- 眼の構造／Eye structure
 - cornea, retina, fovea, blind spot
- 眼のセンサ／Eye sensors
 - rod cell, cone cell, color vision
 - peripheral & central vision
 - image processing
- 奥行き知覚／Depth perception
 - accommodation, vergence
 - binocular disparity
- 眼球運動／Eye movement
 - smooth pursuit, saccade,
 - VOR, OKR

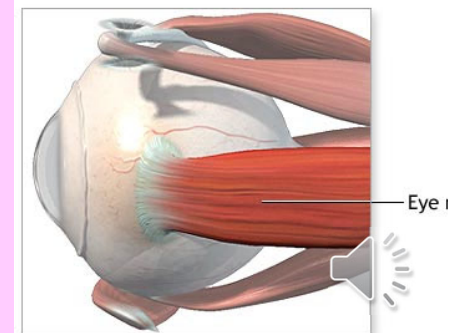
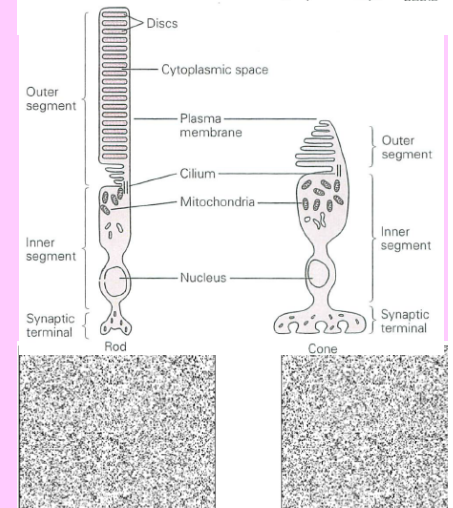
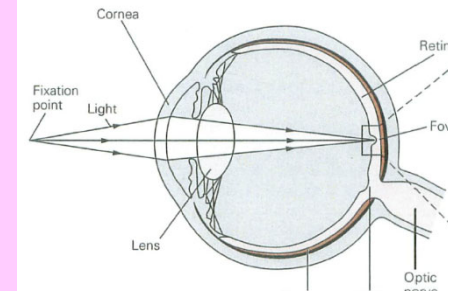

小テスト：一週間以内に提出

Mini Test: Submit in one week

以下の全てに100字以内程度で解答せよ／Answer all questions within 50 words

1. ウェバー・フェヒナーの法則について説明せよ Explain Weber-Fechner's law
2. 調整法について説明せよ Explain the method of adjustment.
3. 極限法について説明せよ Explain the method of limit.
4. 恒常法について説明せよ Explain the method of constant.
5. 錐体細胞と桿体細胞の分布の違いについて述べよ Describe difference of distribution of cone cell and rod cell.
6. 錐体細胞と桿体細胞の明暗および色感受性の違いについて述べよ Describe difference of color and brightness perception of cone cell and rod cell.
7. 焦点調節について説明せよ Explain Accommodation
8. 運動視差について説明せよ Explain Motion Parallax
9. 輻輳について説明せよ Explain Vergence Eye Movement
10. 輻輳調節矛盾について説明せよ Explain Vergence-Accommodation Conflict
11. 両眼視差について説明せよ Explain Binocular Disparity
12. 前庭動眼反射について説明せよ Explain Vestibulo-ocular reflex(VOR)
13. 視運動性眼球運動について説明せよ Explain Optokinetic Response(OKR)
眼底電位計測について説明せよ Explain Electroculography (EOG)
14. 強膜反射法について説明せよ Explain Limbus Tracking Method
15. 角膜反射法について説明せよ Explain Eye Capture System Using Reflection at Horny Coat



実験レポート： pdf形式で一週間以内に提出 Experiment Report: Submit in one week (pdf)

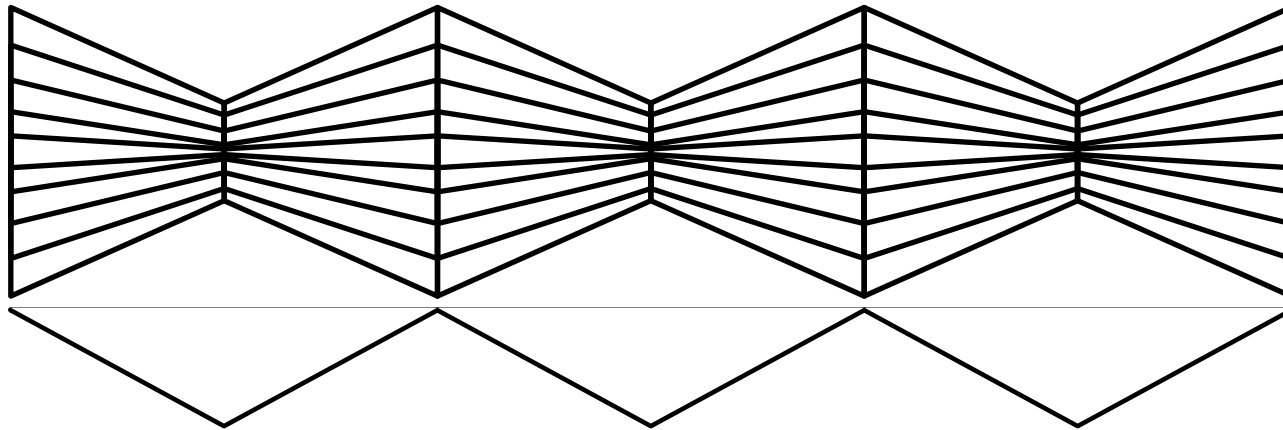

逆遠近錯視(Reverse Perspective Illusion)、ホロウマスク錯視(Hollow Mask Illusion)は、人間の奥行き知覚を利用した錯視である。下記の動画等からその仕組みを理解し、どちらか一方を実際に作成すること。オリジナルの絵であることが望ましい。レポートでは実際に作成したものを複数視点から撮影した様子を示すこと。

Reverse Perspective Illusion and Hollow Mask Illusion are illusions based on human depth cues. Understand the mechanism of these illusions from the following movies, etc., and create either one. It is preferable to use your own original drawing. In your report, you should show the actual picture taken from multiple viewpoints.

<https://www.youtube.com/watch?v=A4QcyW-qTUg&t=119s>

<https://www.youtube.com/watch?v=5pkga3X36MU>





<https://www.youtube.com/watch?v=A4QcyW-qTUg&t=119s>



<https://www.youtube.com/watch?v=5pkg3X36MU>