

Interactive System インタラクティブ システム特論 (3)

Hiroyuki Kajimoto
kajimoto@uec.ac.jp
Twitter kajimoto



Outline of the lecture

1. 人間計測手法／Measuring Human
2. 視覚／Human Vision System
3. 視覚センシング／Visual Sensing
4. 視覚ディスプレイ／Visual Display
5. 聴覚、聴覚インタフェース／Auditory Interface
6. 触覚、触覚インタフェース／Tactile Interface
7. 力覚、力覚インタフェース／Haptic Interface
8. 移動感覚インタフェース／Locomotion Interface

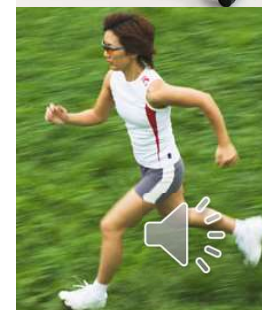
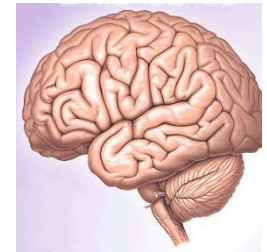

TODAY's TOPIC



- 光学素子 / Optical Elements
- 光学の基礎 / Basics of Optics
- 3次元イメージング / 3D Image Sensing



Structure of a Camera

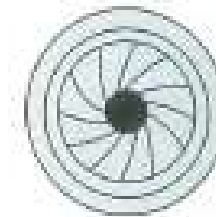
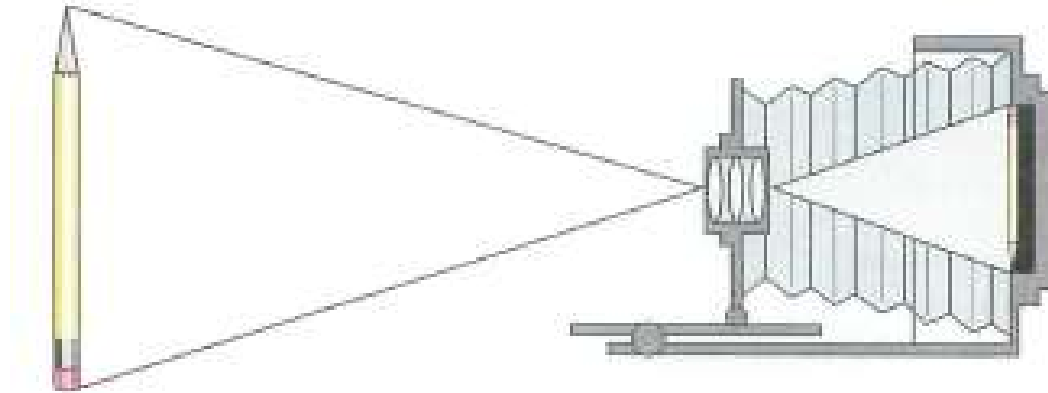

カandel神経科学(Principles of Neural Science)

<https://www.medsi.co.jp/kandel/syousai/index.html>

- Lens
- Iris
- Shutter
- Film



レンズ / Lens

- Convex Lens

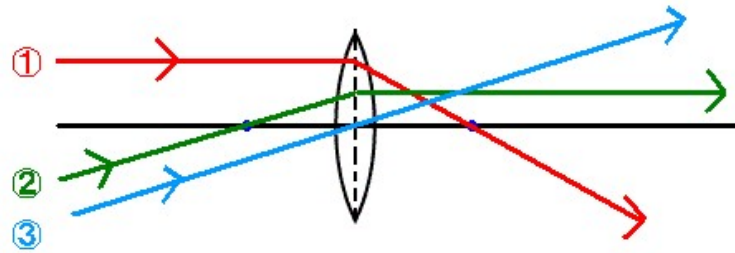

- Concave Lens

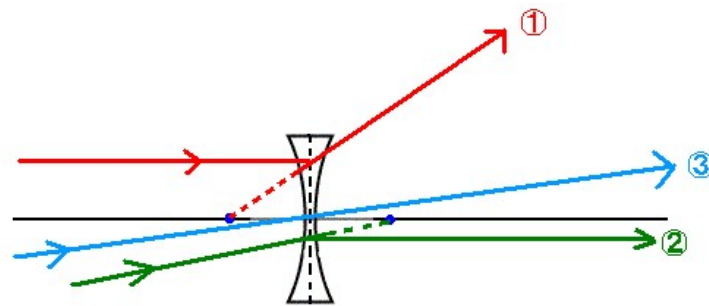

レンズ, ミラー以外でインタラクティブシステムでよく用いられる光学素子(の一部)

Other optical elements for interactive system

- フレネルレンズ / Fresnel Lens
- レンチキュラレンズ / Lenticular Lens
- ハーフミラー / Half Mirror
- 偏光板 / Polarization Plate
- プライバシーフィルタ
- 波長フィルタ / Low-pass/High-pass/Band-pass Filter
- 光ファイバ / Optical Fiber
- 再帰性反射材 / Retroreflector
- 再帰透過光学素子 / Micro Mirror Array Plates



フレネルレンズ / Fresnel Lens

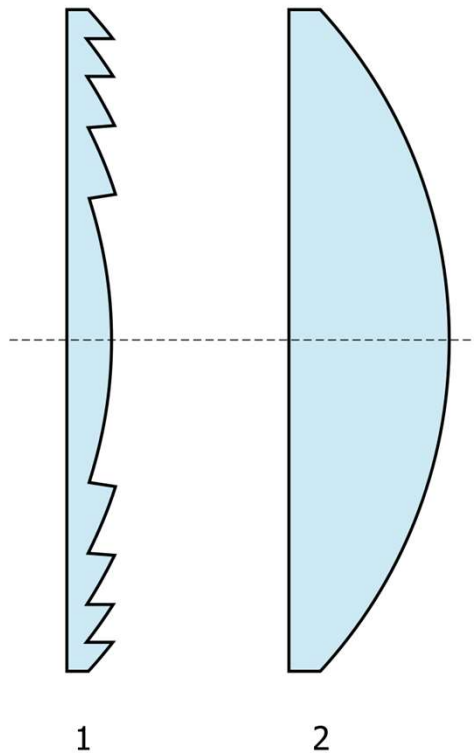

- 薄い平板状のため、大面積のレンズが安価、軽量に作成可能
Thin plate which surface has lens structure. Becomes cheap and light weight.
- 照明光学系に多く使用(カメラのストロボ, 灯台等)
Occasionally used for lighting (flash, lighthouse, etc)
- フレネルミラーもある(表面に蒸着)
Fresnel mirror can be made with surface metal coating.



フレネルレンズ / Fresnel Lens

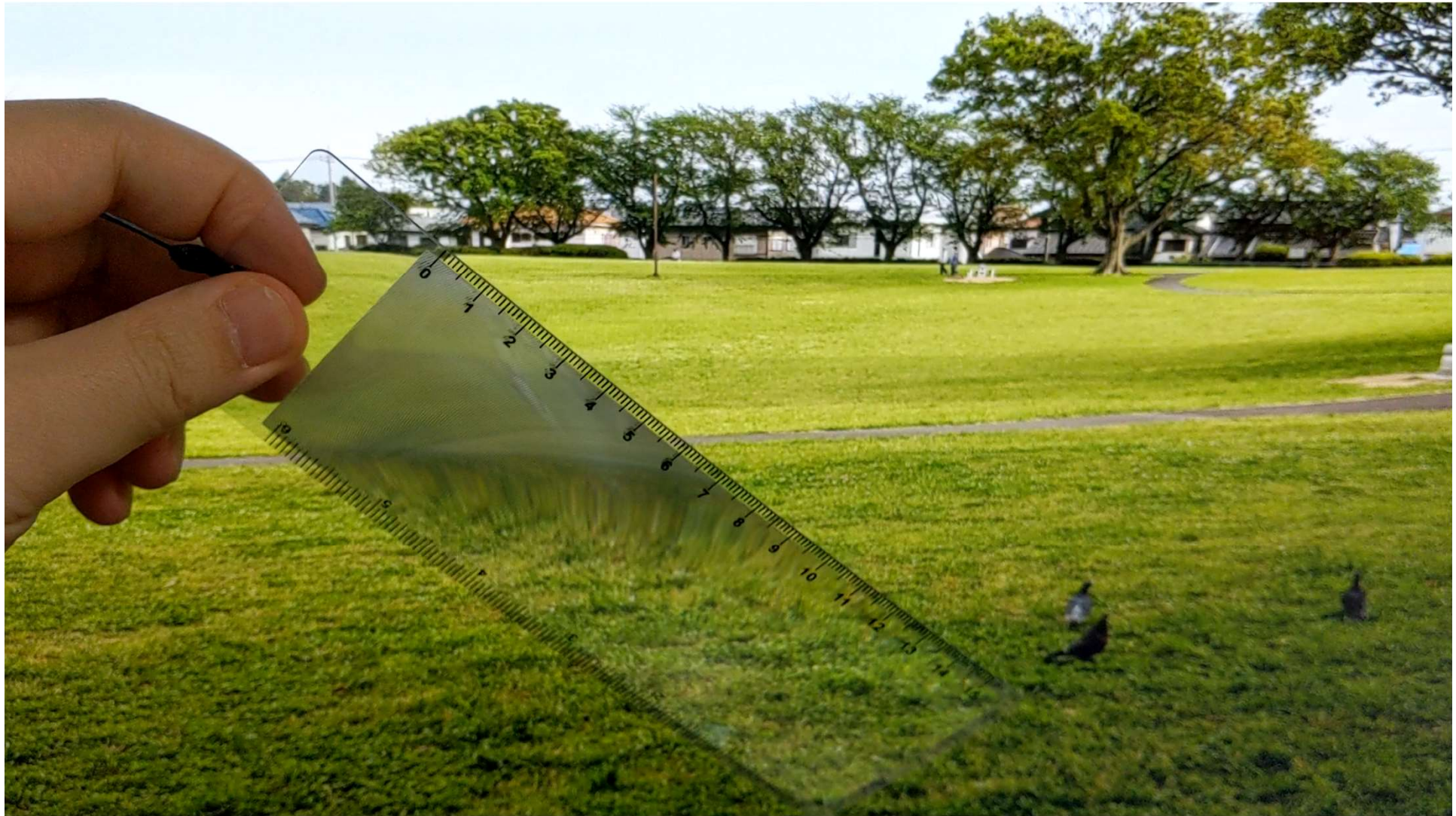

オーバーヘッドプロジェクタ Overhead Projector



Overhead Projector (Wikipedia)
https://en.wikipedia.org/wiki/Overhead_projector



- ミラー
光路屈曲+反転
- レンズ
実像の生成(反転)

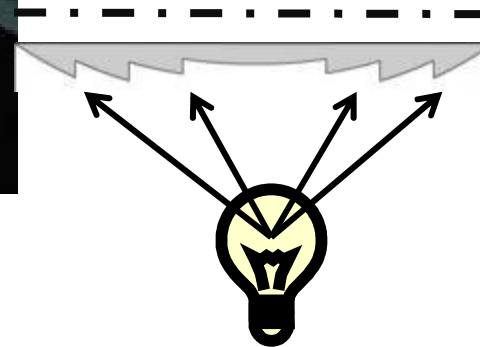

- OHPシート
- フレネルレンズ
平行光ないし集約光
の生成(コリメータ)
- 光源



レンチキュラレンズ／Lenticular Lens

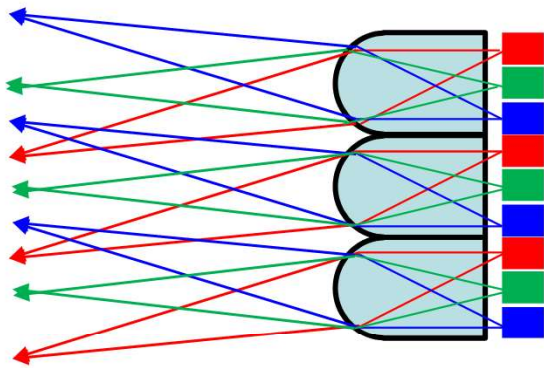

- かまぼこ型レンズの群れ
array of magnifying lenses.
- マイクロレンズアレイの1次元版

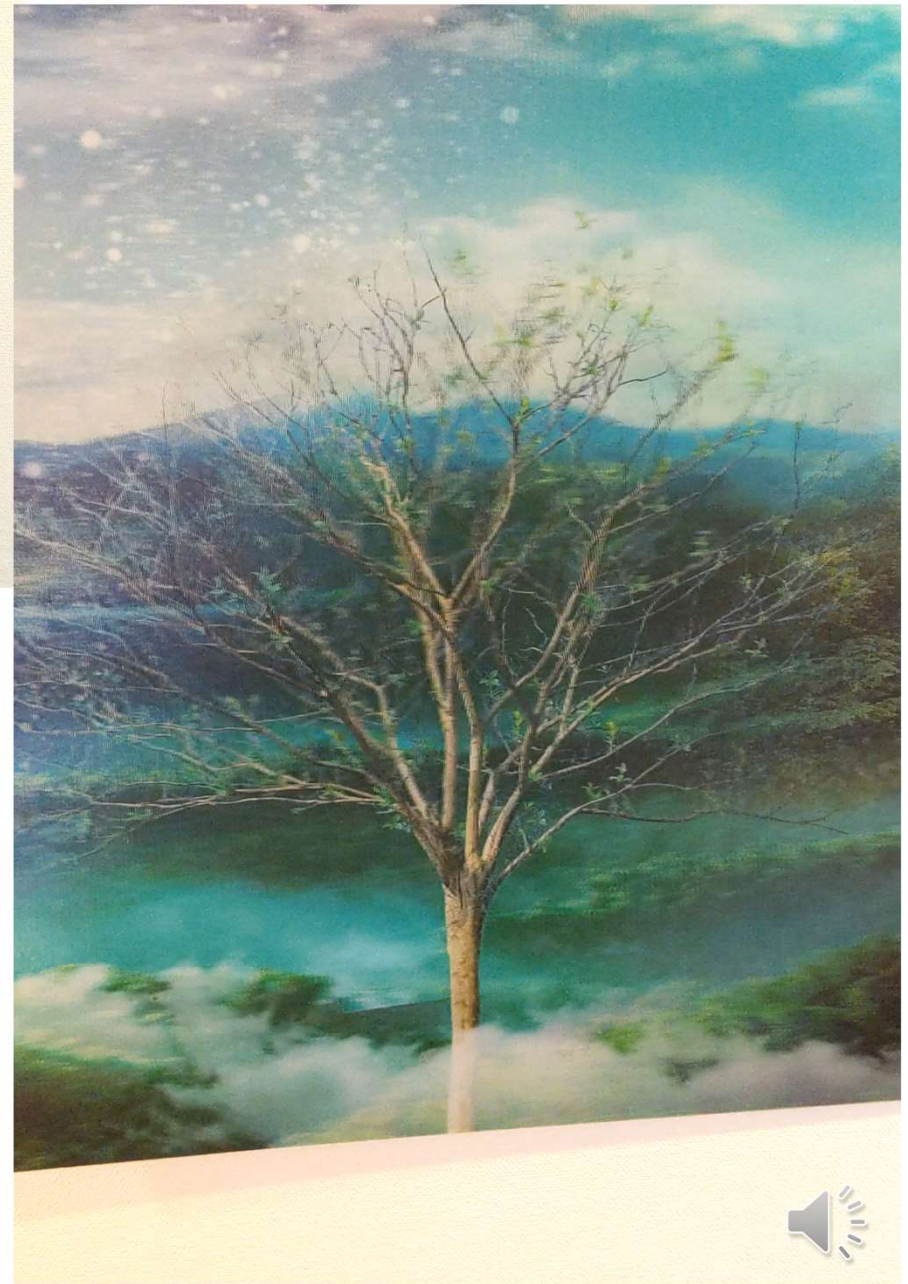

(参考)リアプロジェクションTV

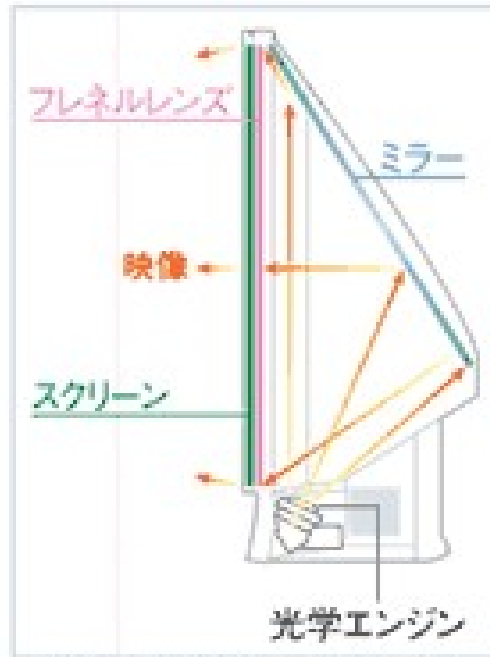

<http://joshinweb.jp/av/project4.html?CKV=051104&ACK=REP>

<「HD-61/52MD60」の構造図>

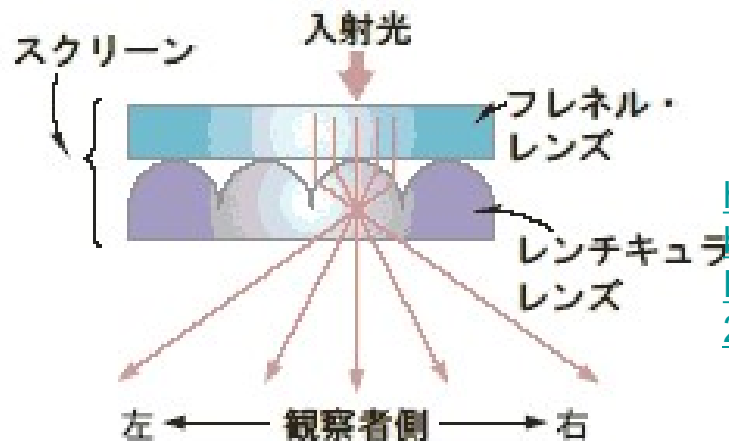

<http://techon.nikkei.co.jp/article/WORLD/20060306/114225/>

- フレネルレンズ: 入射光の平行化
- レンチキュラレンズ: 左右方向の視認性の向上



(参考)レンチキュラレンズを用いた歩行誘導
／Walk Navibation by Lenticular Lens



http://www.youtube.com/watch?v=VSBRG1_5s2E

Hiromi Yoshikawa, Taku Hachisu, Shogo Fukushima, Masahiro Furukawa, Hiroyuki Kajimoto: ""Vection Field" for Pedestrian Traffic Control", Emerging Technologies Session, ACM SIGGRAPH, 2011



ハーフミラー(ビームスプリッター・マジックミラー) ／Half Mirror, Beam Splitter

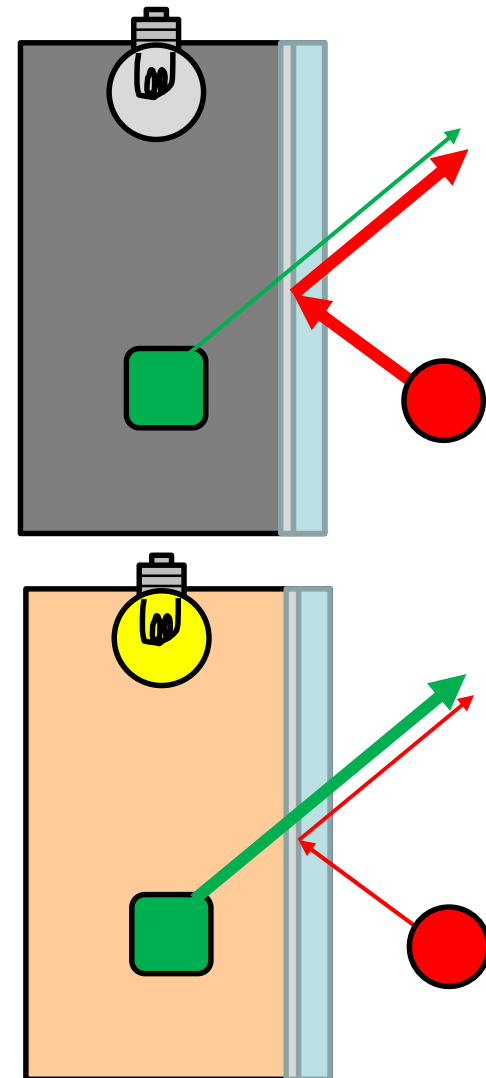

全反射＋透過の両方の性質を持つ
Half reflected and half transmitted.

- 平面蒸着タイプ、プリズムタイプ、特殊タイプ
half-silvered mirror, prism, etc.

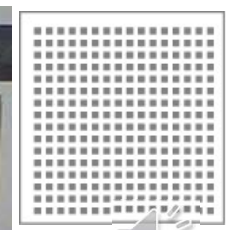

Beam splitter (Wikipedia)

https://en.wikipedia.org/wiki/Beam_splitter



ハーフミラーで表情？を作る / Half Mirror for face modification



ハーフミラーを用いたインタラクティブAR Interactive AR using Half Mirror



A-me: Augmented Memories (SIGGRAPH ASIA2013)
J. Puig, A. Perkis, A. S. Hoel, A. Cassinelli
https://www.researchgate.net/publication/262389666_A-me_Augmented_memories

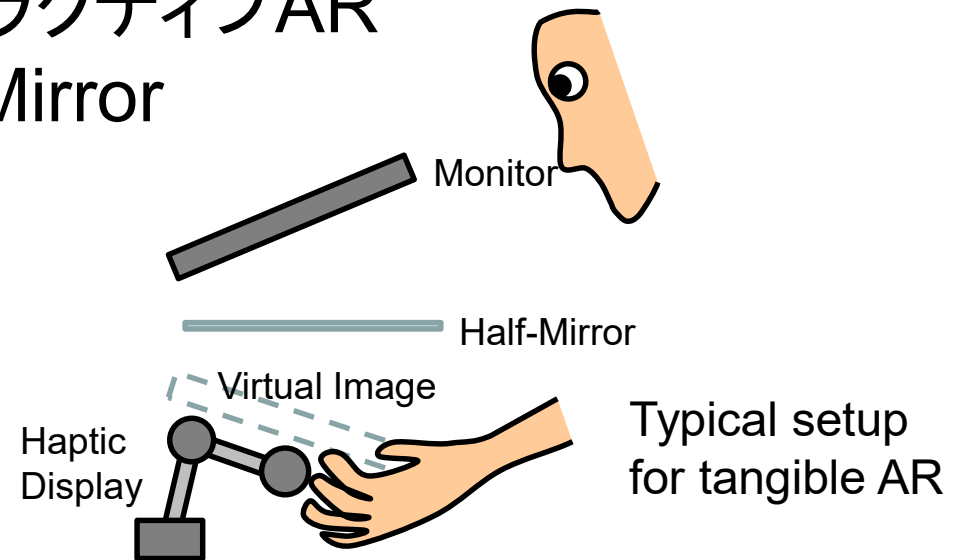

<https://www.youtube.com/watch?v=l-gXGT-guPQ>

T. Yoshinaga, Tabletop Holographic AR with Half-mirror and Marker Tracking



ダイクロイックミラー: 特定波長のみ反射

Dichroic Mirror: reflect specific wavelength



<https://www.sony.co.jp/Fun/design/history/product/1990/dcr-vx1000.html>

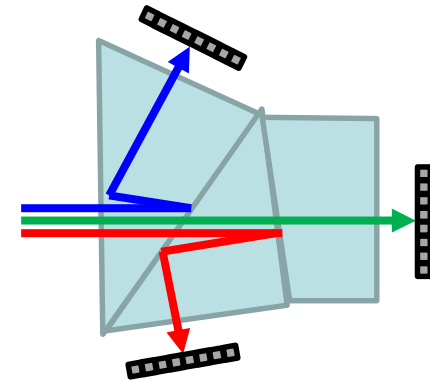

- 3板式CCDカメラ等で色分解に使用
- コールドミラー: 可視光を反射, 赤外を透過
- ホットミラー: コールドミラーの逆



偏光板 / Polarization Plate

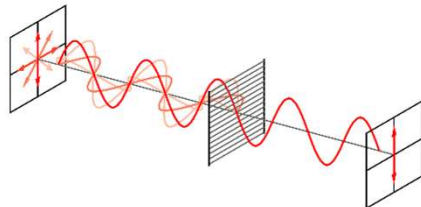
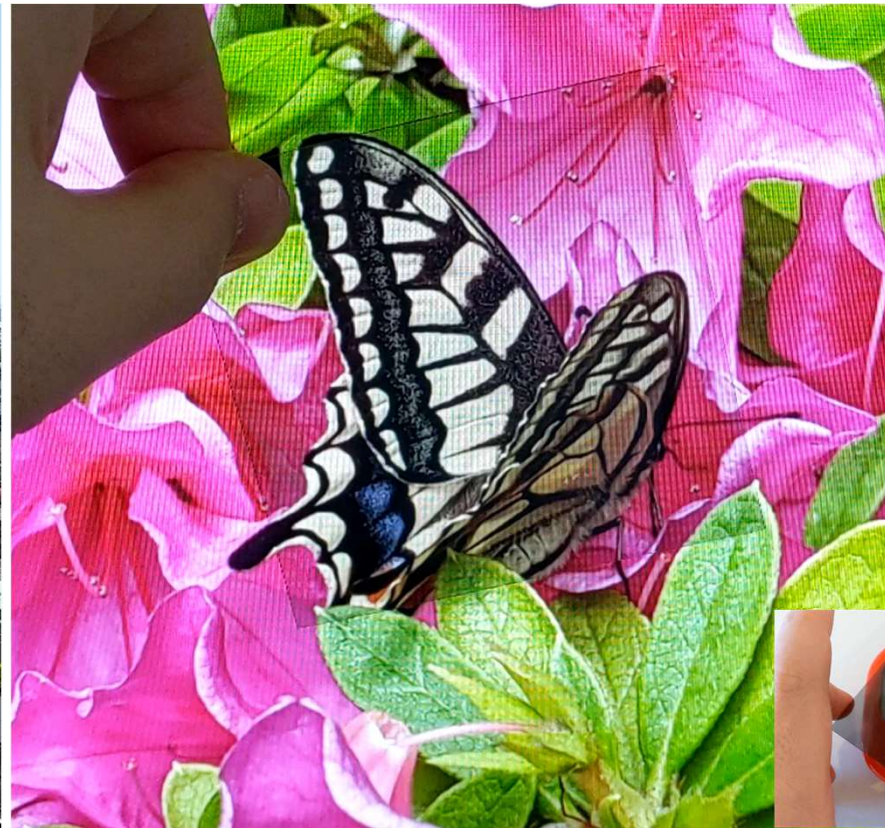

Polarizer (Wikipedia)
<https://en.wikipedia.org/wiki/Polarizer>

- Optical filter that lets light waves of a specific polarization pass through while blocking light waves of other polarizations.
- Two polarization plates can modulate the amount of light.
- Used in LCD displays.

液晶分子の性質を利用した液晶パネルの仕組み

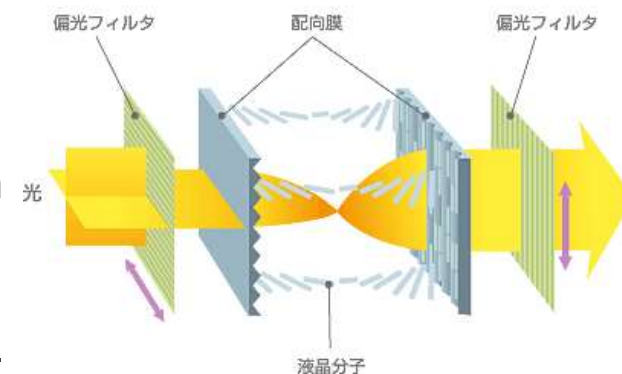

<http://www.tdk.co.jp/techmag/knowledge/200702/index.htm>



プライバシーフィルタ / Privacy Filter

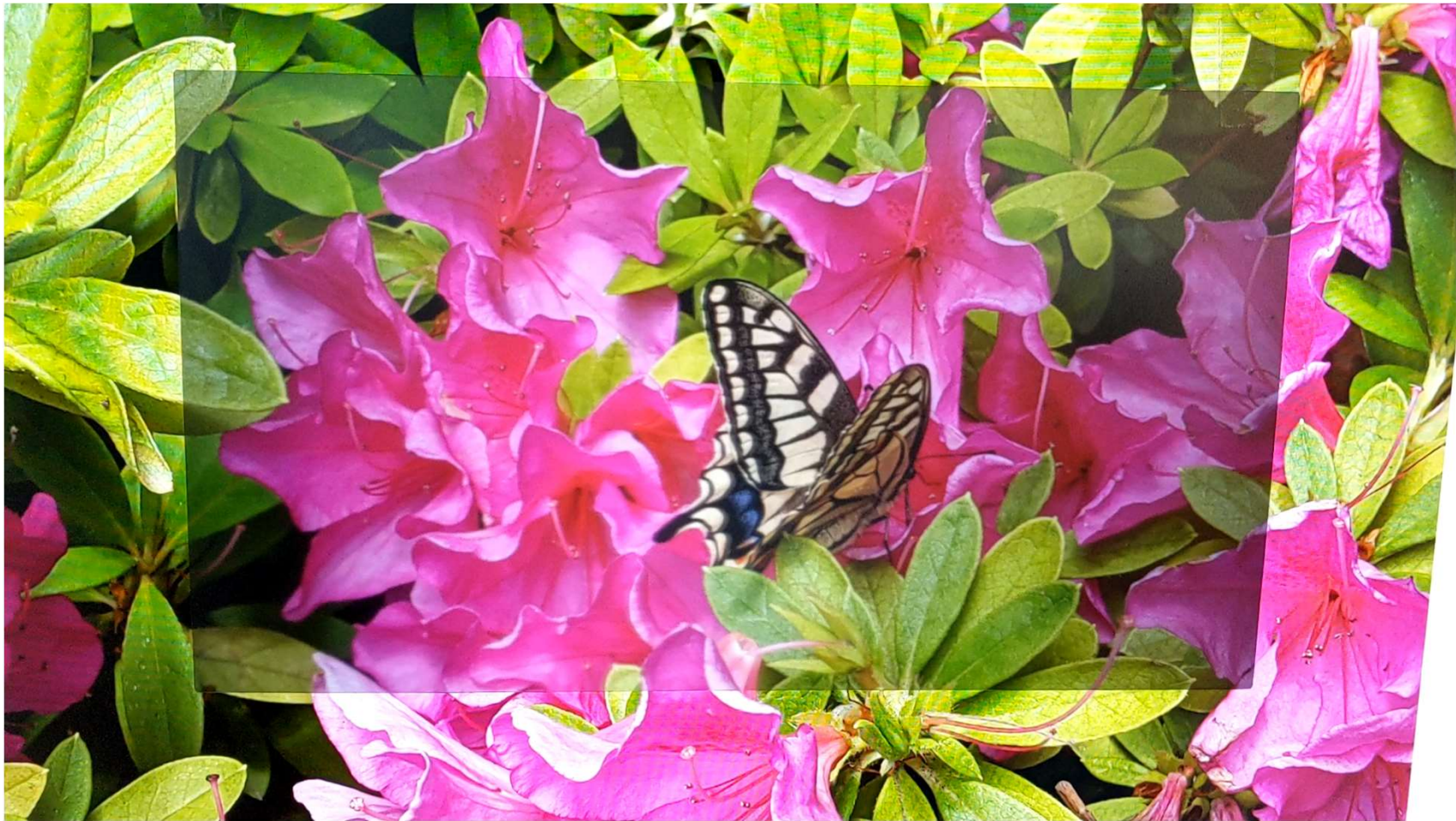

- 深さ方向の微小な柵により覗き見防止
Fine shutters blocks oblique incident light.
- 撮影時の照明光入射防止など

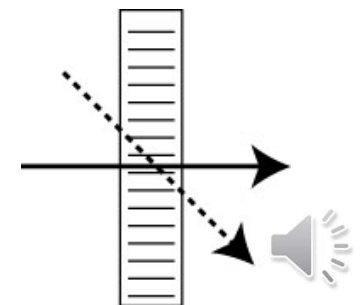

波長フィルタ

／Low-pass/High-pass/Band-pass Filter

- 照明光による反射光のみ撮影したい
- 太陽光の影響を避けたい
- ハイパスフィルタ(赤外防止フィルタ)
 - カメラレンズに必ず付属。
赤外光でホワイトバランスが崩れるのを防ぐ。



- ローパス(ロングパス)フィルタ(赤外透過フィルタ、IRフィルタ)
 - 赤外照明による撮影
 - 水蒸気等による拡散が少なくなり、風景がクリアになる
- バンドパスフィルタ



(参考)IRフィルタの利用

- 水蒸気等による拡散が少なくなり、風景がクリアに
- 血管をクリアに観察

<http://www.youtube.com/watch?v=S2eexdjHHSU>

<http://www.youtube.com/watch?v=l7qq6XPDVO8&NR=1>



赤外線を用いた接触検出 / Touch detection by IR

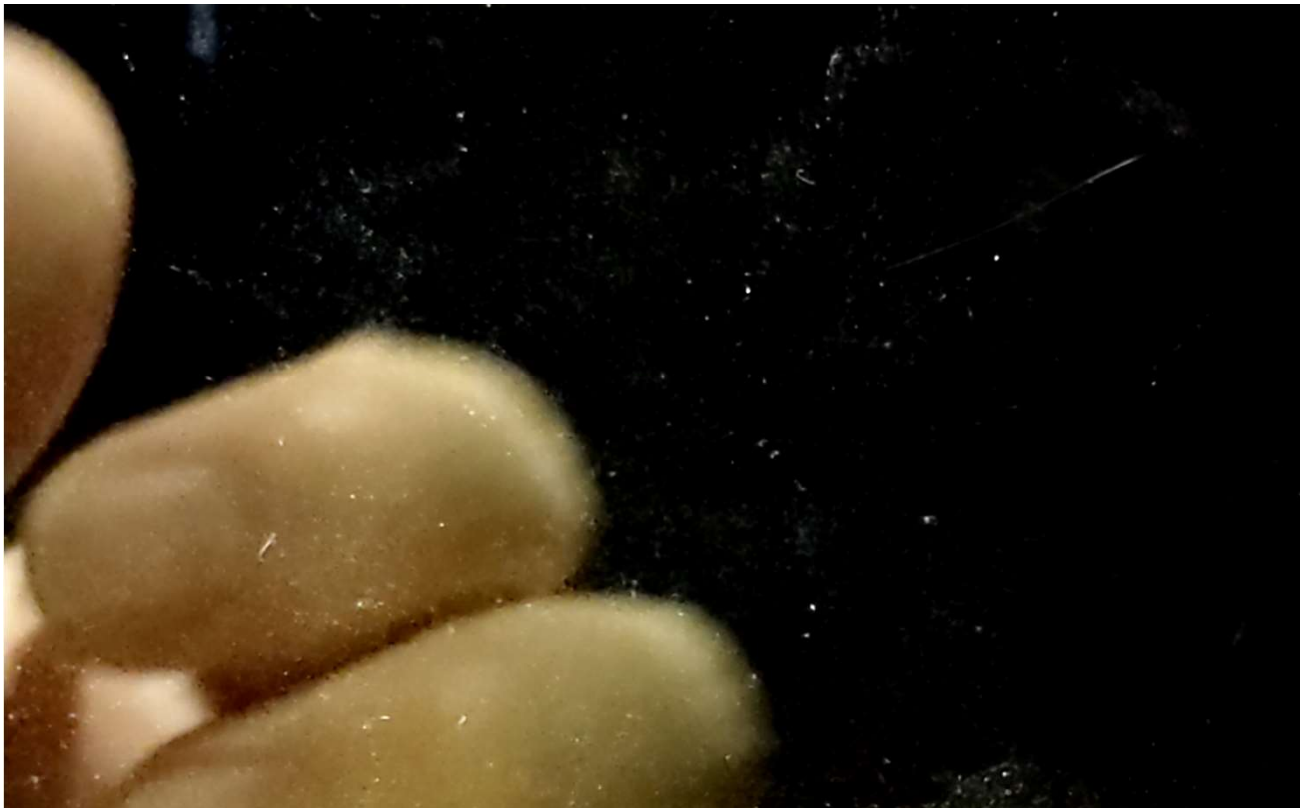
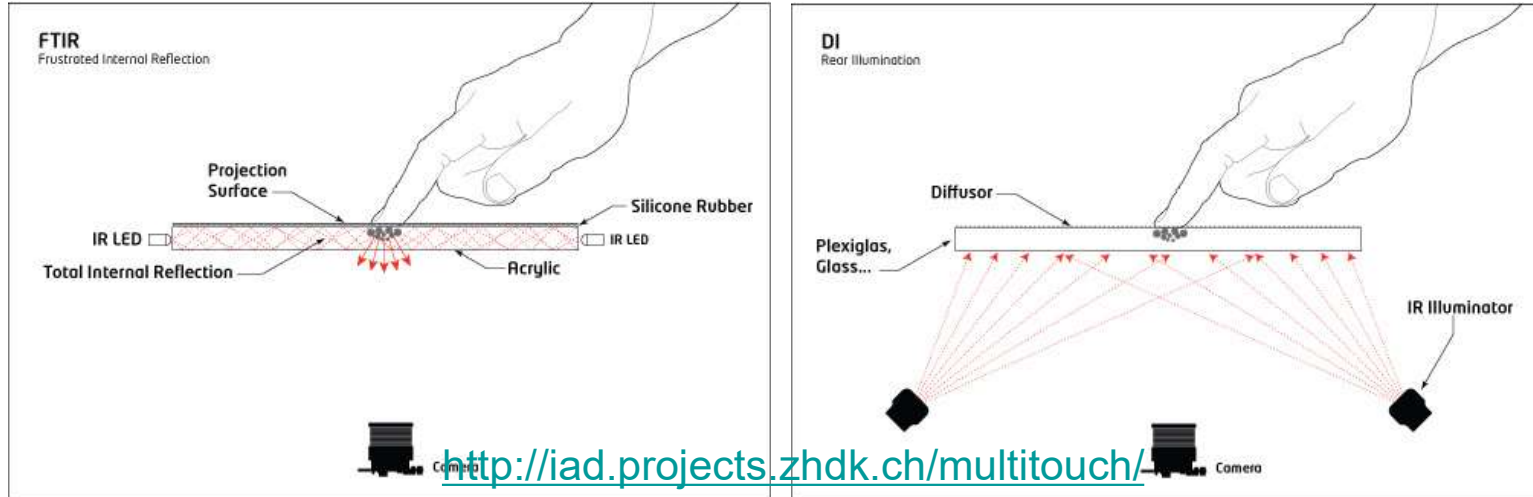

FTIR方式。
白色光＋通常の
カメラでの撮影例
White lighting +
RGB cam
example.



光ファイバ／Optical Fiber



<https://www.olympus-ims.com/ja/fiberscope/>



Fiber scope (Wikipedia)

<https://en.wikipedia.org/wiki/Fiberscope>

- ファイバースコープ／Fiber Scope
 - 撮像素子が入れない微細な場所で使用。現在はほぼイメージセンサに置換。
Used to observe thin places. Most is now replaced by image sensor.
- テレビ石／Ulexite
 - 光ファイバ束。自然の鉱石。人工的にも作成。テーパをつけた拡大鏡としても。
Bundle of Optical Fiber. Natural
 - テーパー型で画素拡大／縮小機能をもつものも。
Tapered-type is used to change size of the image.



<https://ja.gz-honsun.com/china/optic-dcmos-fiber-optic-taper>

テレビ石の再発見 / Rediscovery of Ulexite



<https://www.youtube.com/watch?v=82r4I9Ks5Zc> (ITS2011) K. Fukuchi, R. Nakabayashi, T. Sato, Y. Takada: Ficon: a tangible display device for tabletop system using optical fiber

<https://www.youtube.com/watch?v=eTeXTbXA6-Y> (UIST2012) K.D. D. Willis, E. Brockmeyer, I. Poupyrev: Printed Optics: 3D Printing of Embedded Optical Elements for Interactive Devices

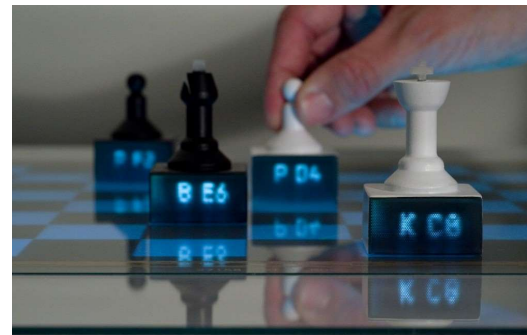

<https://la.disneyresearch.com/publication/printed-optics-3d-printing-of-embedded-optical-elements-for-interactive-devices/>

3Dプリンタが光ファイバ構造を造形できるようになり、テレビ石がインタラクション要素として再発明された。



TODAY's TOPIC



- 光学素子 / Optical Elements
- 光学の基礎 / Basics of Optics
- 3次元イメージング / 3D Image Sensing



凸レンズの原理 / Convex Lens Principles

- Rule1 : Ray that runs parallel to the lens axis passes through focal point.

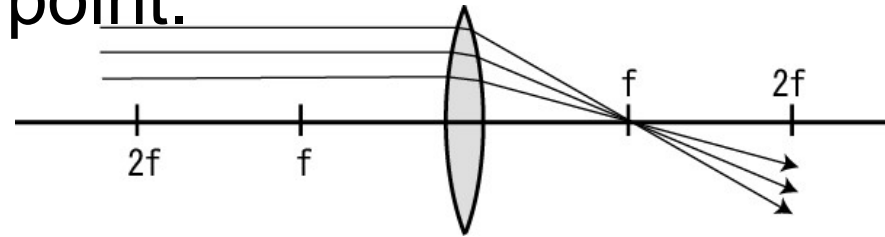

- Lemma : Ray that passes focal point becomes parallel to the lens axis.

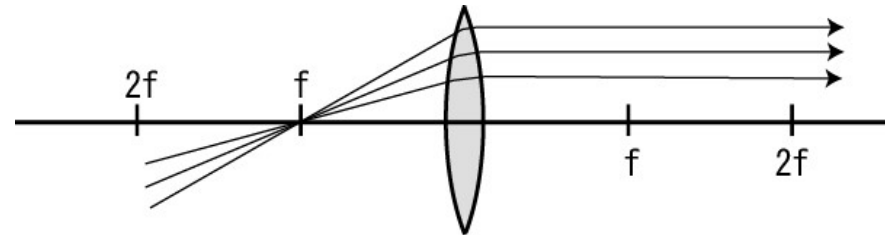

- Rule2 : Ray that passes lens center does not change its direction.

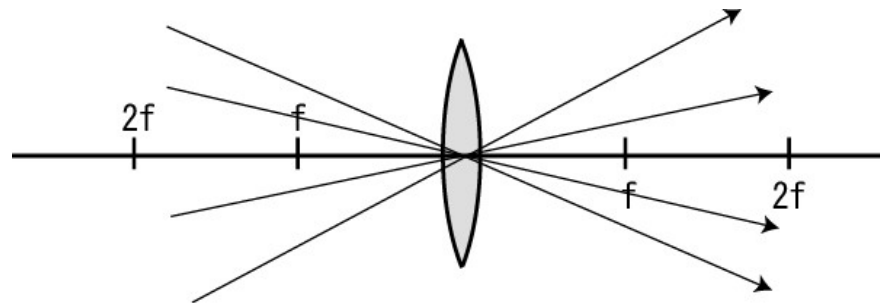

虚像と実像

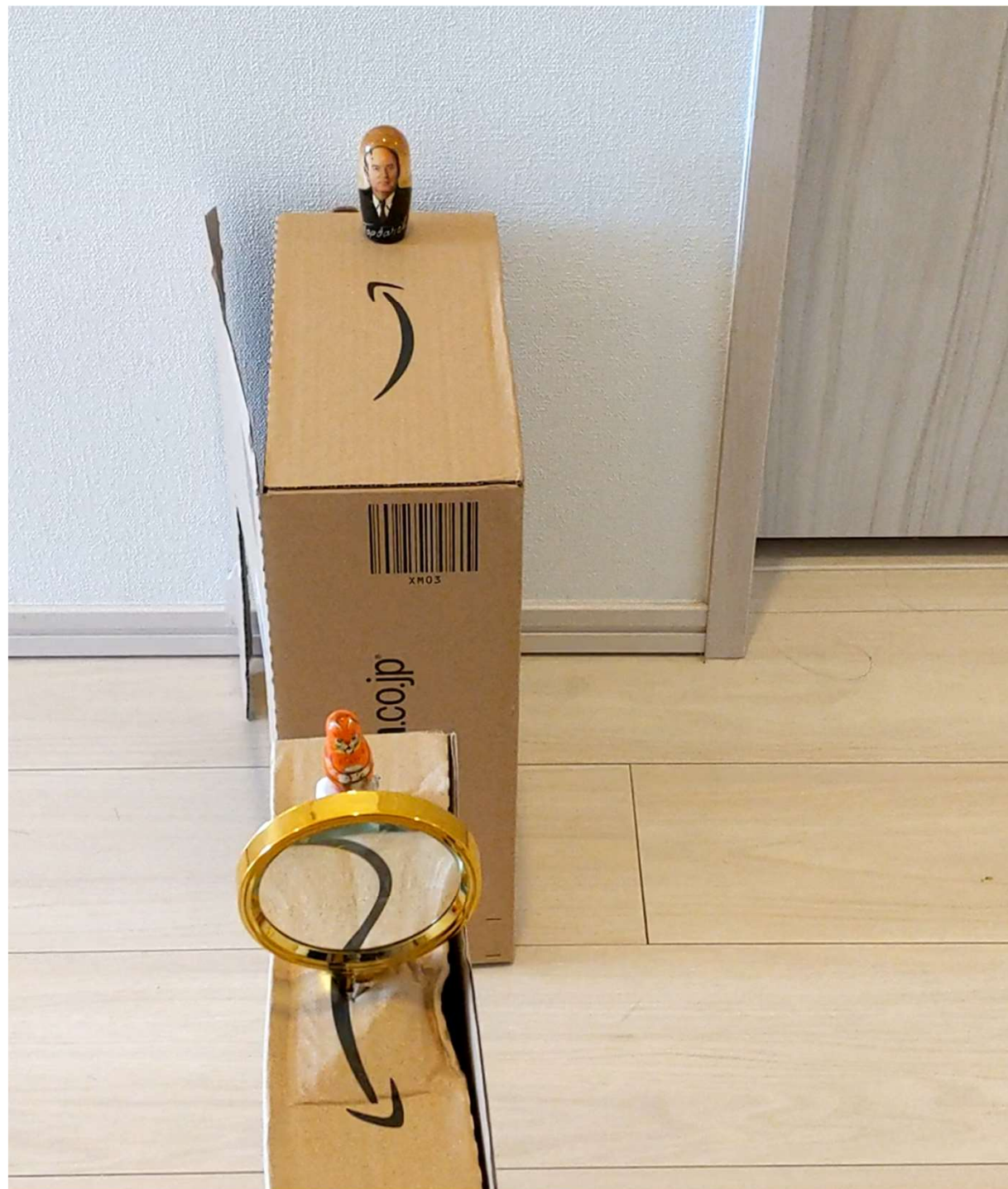

実像 / Real Image

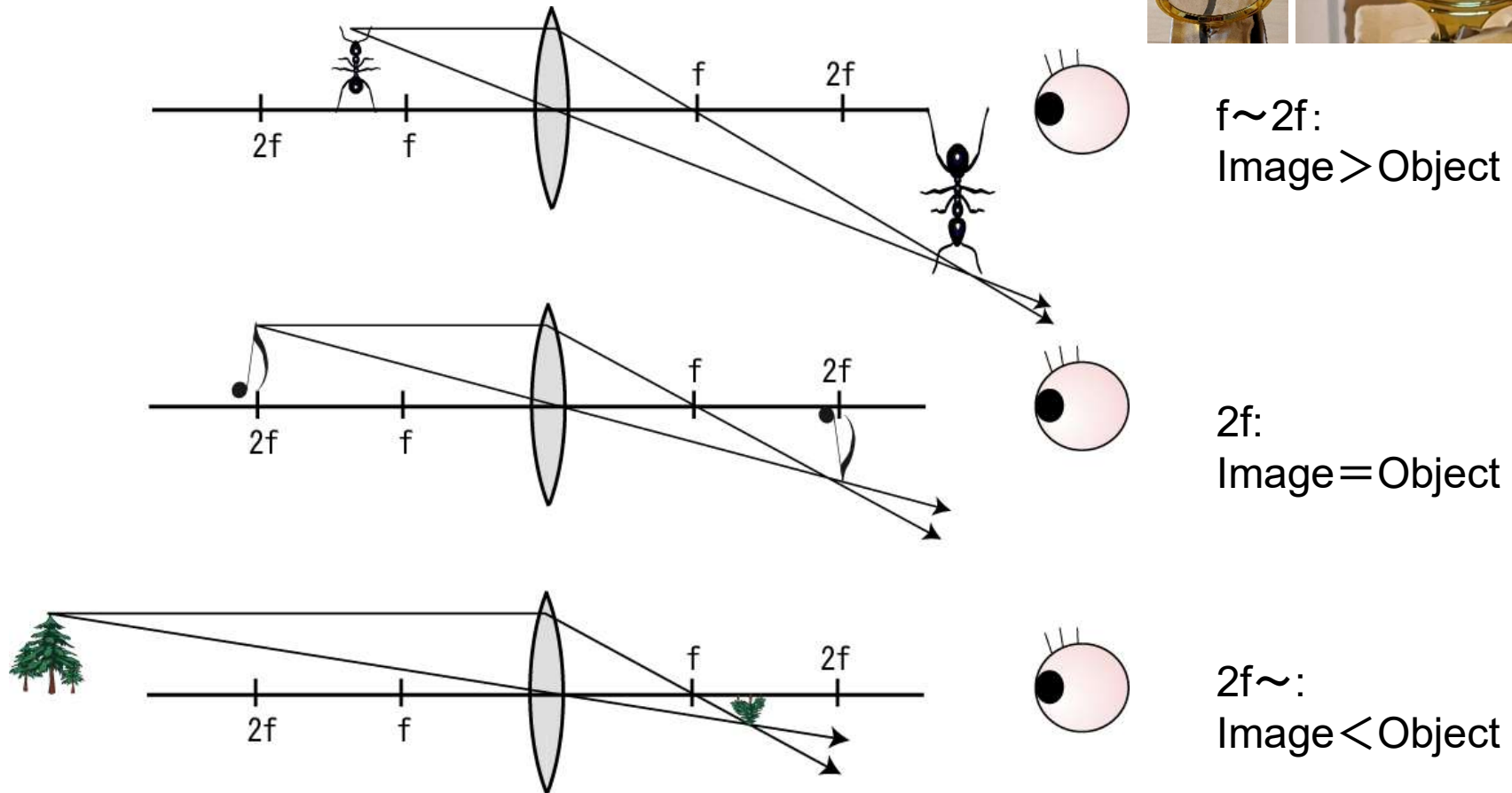

The rays **really** comes out from the **image**.



虚像 / Virtual Image

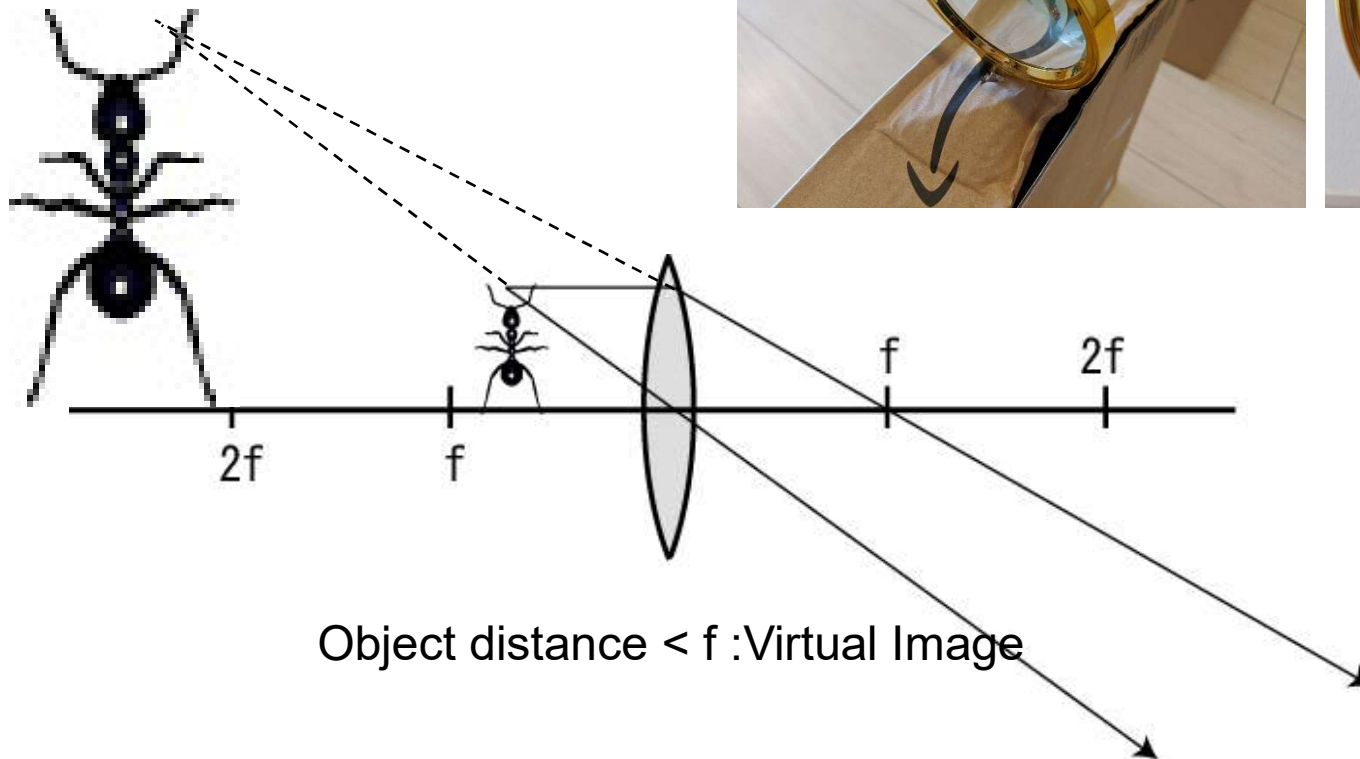

The ray does **not really** come out from the image, but **virtually** (=has the same effect as if) comes out from the image.



凹レンズの原理 / Concave Lens Principles

- Fixed Rule 1 : Ray that runs parallel to the axis refracts, and runs as if it comes from back focal point.

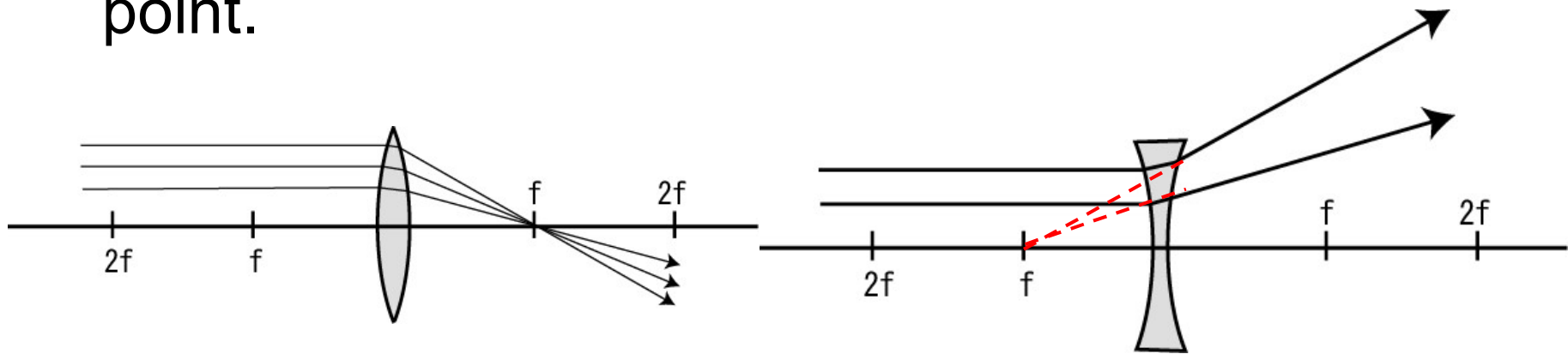

- Only virtual image can be formed.

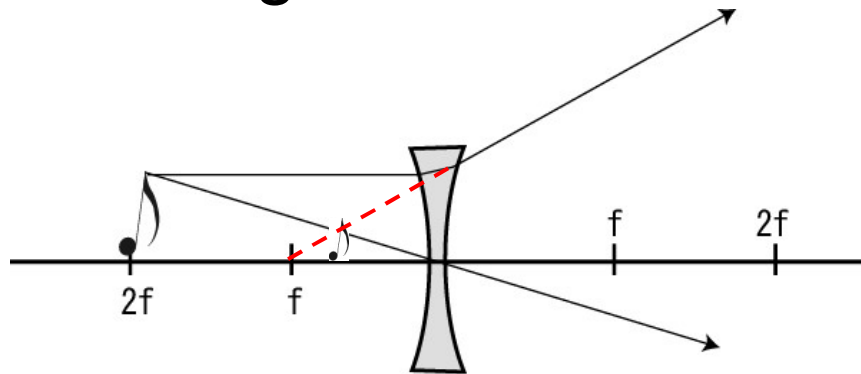

像とは何か

What is **Image**?



クイズ／Quiz

You are wandering
dark space.

Now, One directional,
parallel rays fill the
whole space.

What do you see?

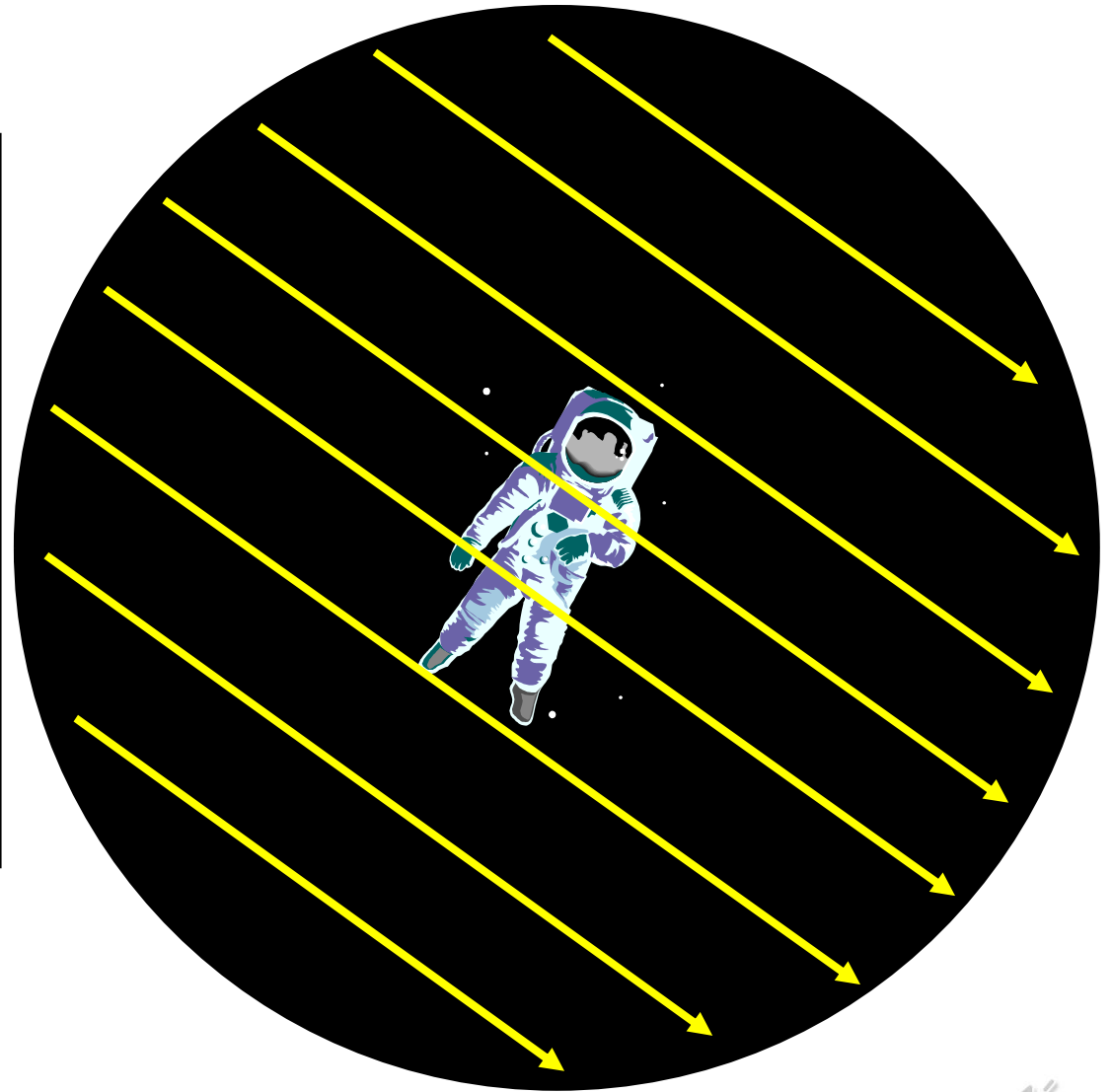

※このクイズは東京大学の稲見昌彦先生に伺ったものです。



像とは何か？ / What is **IMAGE**?

Image is a
virtual/real
light source
from which
rays come out

omnidirectionally.



「像」の理解は簡単ではない

Do we really understand refraction **IMAGE**?

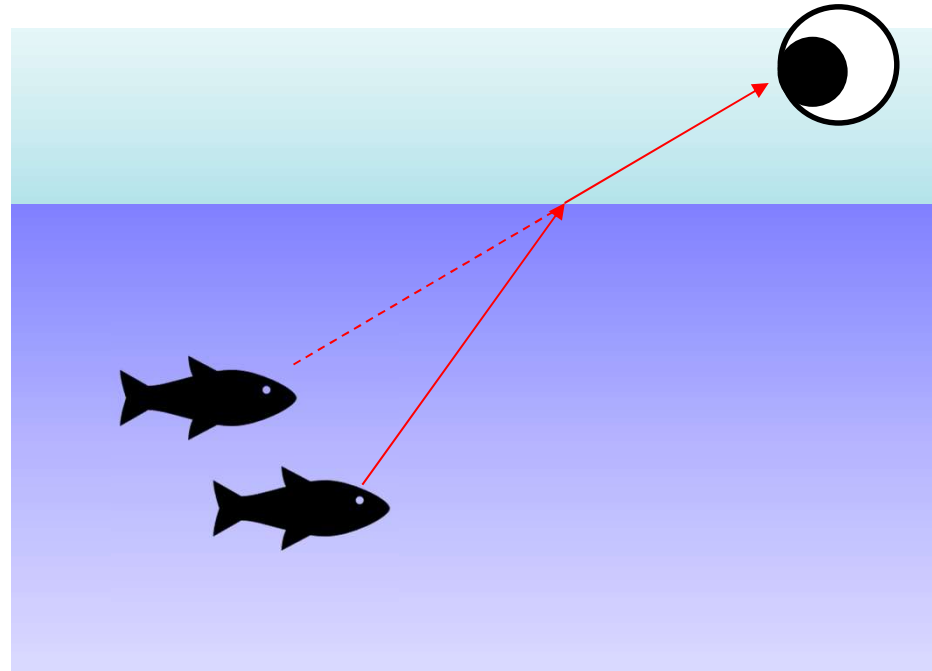

Figures in elementary school textbooks:

Only one line explains “shallow fish”.

- Is one line **enough** to explain the fish position?
- Is **oblique incident angle** necessary?



クイズ / Quiz

What we know: Due to refraction, objects in water seem shallower.

Question: What about **horizontal distance**?

- (A) A little far
- (B) A little near
- (C) Does not change

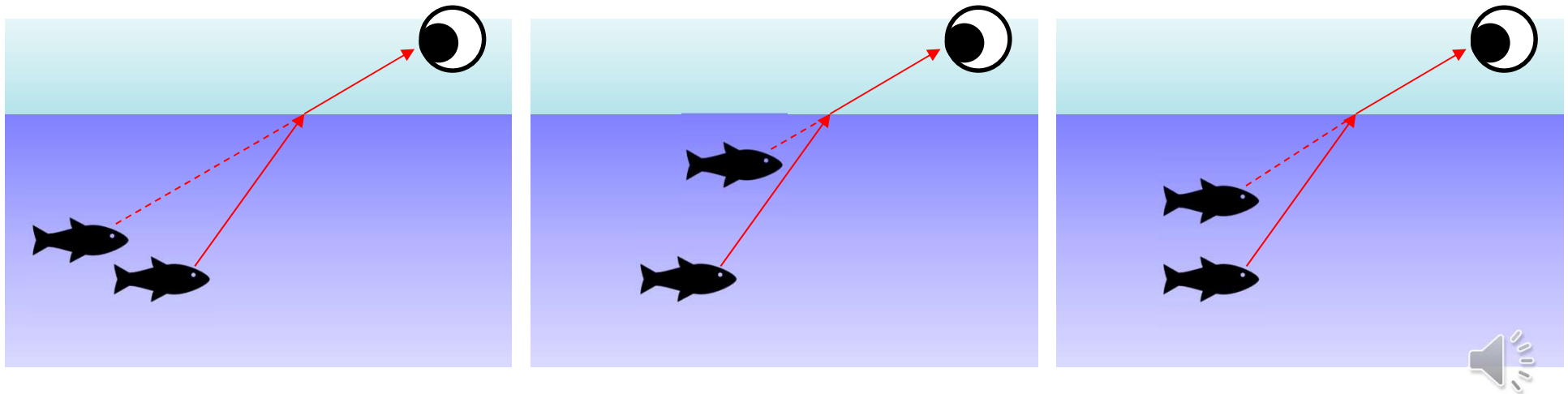

クイズからわかること / What the quiz shows is

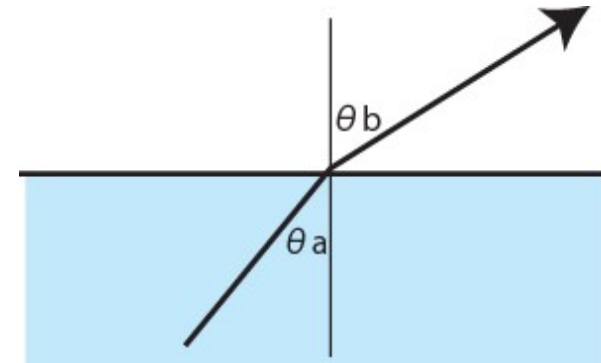
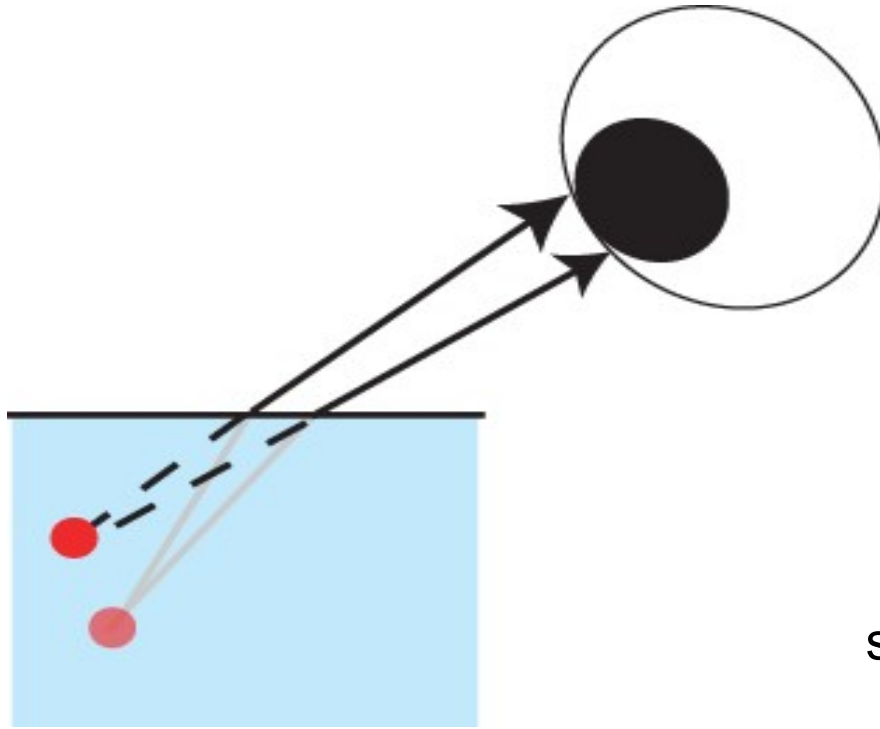

Snell's law:
 $\sin\theta_b / \sin\theta_a = n$ (index of refraction)

“One line” does not explain everything.

Remember the definition of “IMAGE”,
and think about omnidirectional rays
by using 2 rays.

It gives the position of “IMAGE”



「浅く見える」ためには「斜めから見る」必要なし

Oblique incident angle is not necessary for “Shallow” perception.

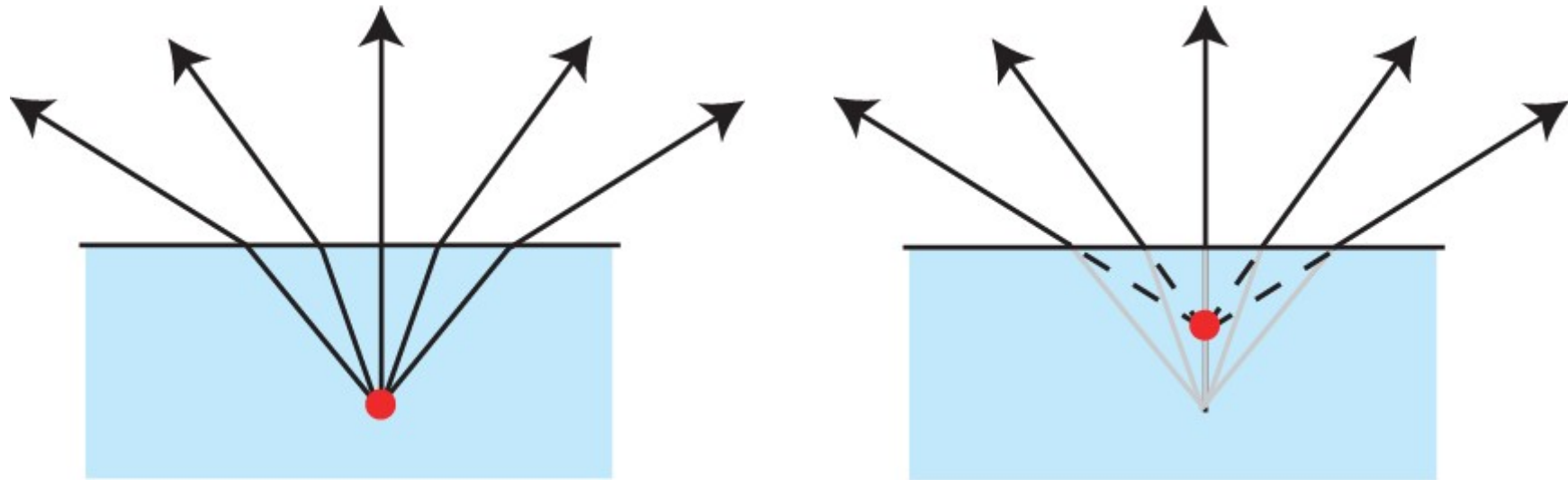

Looking from overhead, it still looks shallower.

IMAGE redefinition:

● Ideally... **Any rays** from a point can be regarded as rays from different point.

● Practically... Rays from a point to eye's pupil can be regarded as rays from different point.

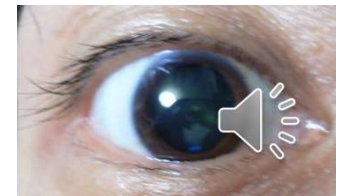

「屈折像」に関する誤解

Misunderstanding of refraction phenomenon.

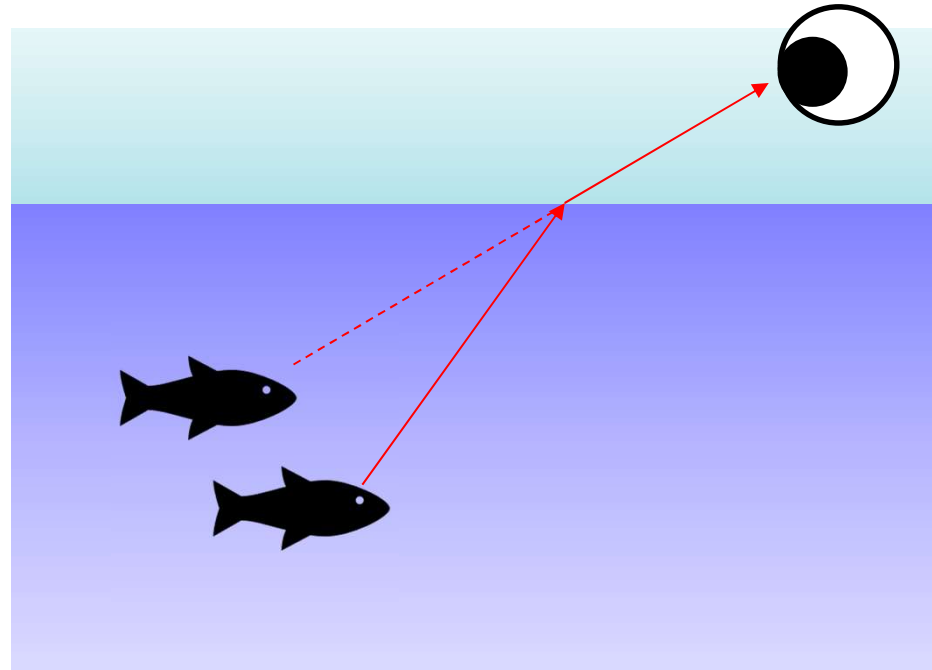

“Single line” can explain refraction
phenomenon, but not **IMAGE**.

IMAGE should emit rays to any
directions, like real object .



そもそも「反射像」を理解しているか？

Do we really understand reflection **IMAGE**?

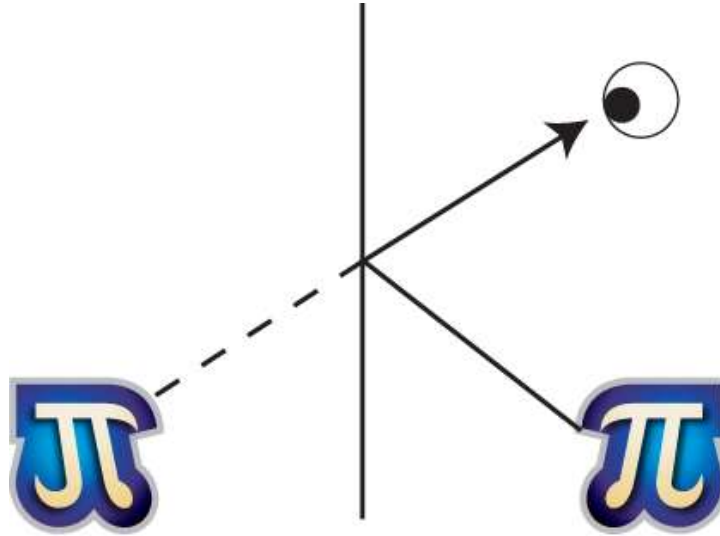

Single ray line can explain reflection **phenomenon**,
but can not explain reflection **IMAGE**.

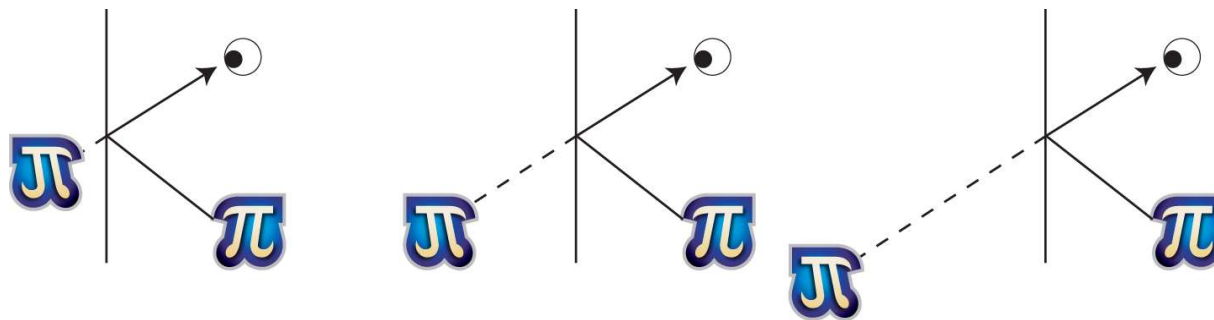

Which one is correct? → can not be judged by single line.



ミラーはミラクル / Mirror is Miracle

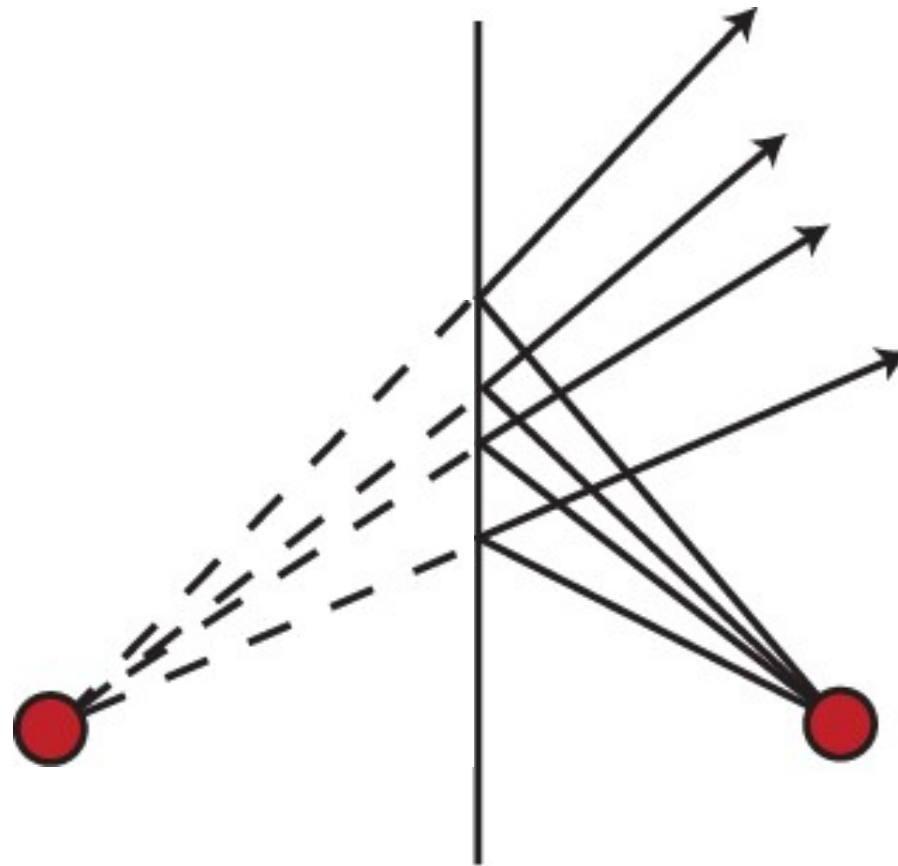

By flat mirror, (almost) ANY rays from a point can be regarded as rays from a different point, which obeys the pure definition of IMAGE.

In this case, the image is “**Virtual Image**”



(IEEEVR2021) Fatma Ben Guefrech, Florent Berthaut, patricia plénacoste, Yvan Peter
Revealable Volume Displays: 3D Exploration of Mixed-Reality Public Exhibitions



<https://pod.univ-lille.fr/video/19141-revealable-volume-displays-3d-exploration-of-mixed-reality-public-exhibitions/>

- 博物館等の展示物の前にガラス板があることを利用、手持ちのタブレットをかざすことで、展示物の情報や断面等を展示物の位置に表示する。
- Using a glass plate in front of an exhibit at a museum, etc., by holding up a handheld tablet, information and cross-sections of the exhibit are displayed at the location of the exhibit.



再帰透過光学素子 / Micro Mirror Array Plates (MMAPs)

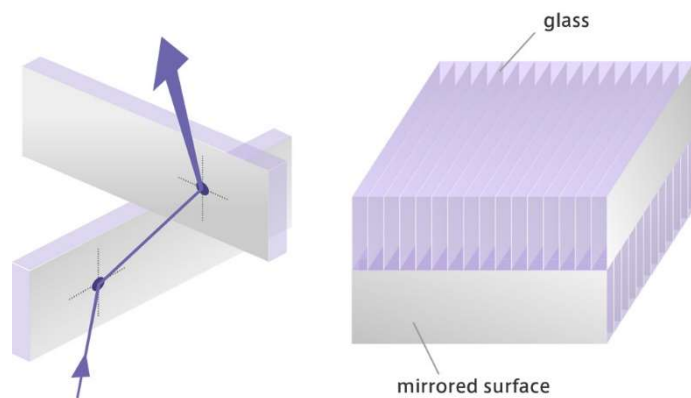
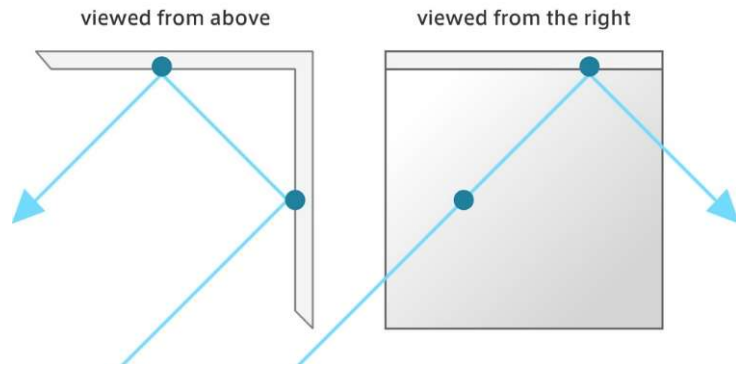

<https://aska3d.com/en/technology.php>

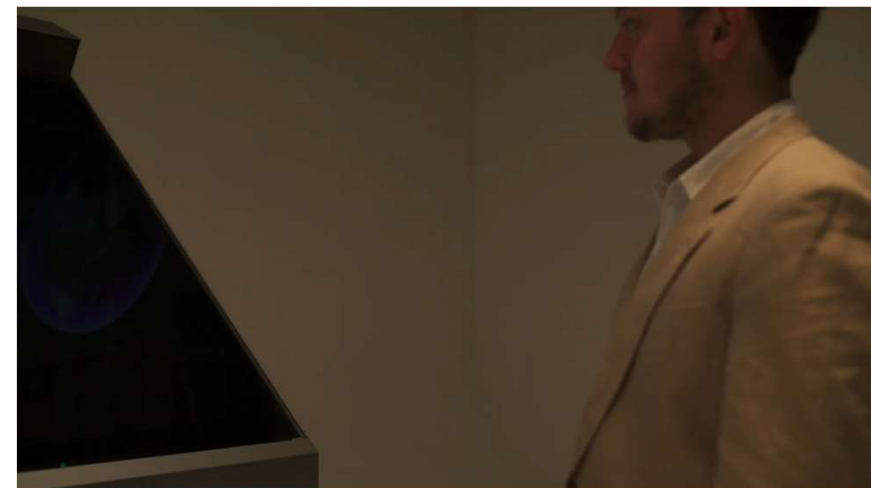
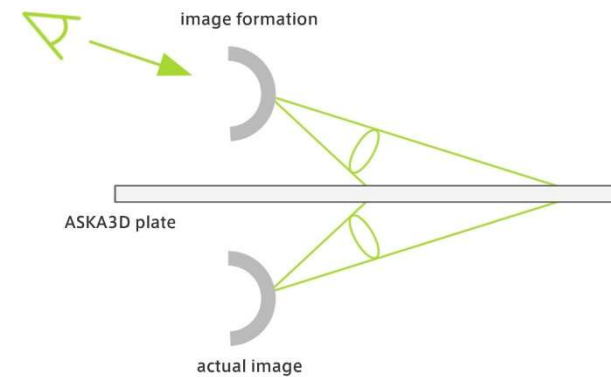

<https://www.youtube.com/watch?v=KgAvRtpPY-4>
DS976 - ASKA3D

- 直交する短冊状ミラーの集合体を貼り合わせたもの。
- コーナーキューブと同様に再帰反射する軸と透過する軸。
- 歪みのない空中像(実像)を簡便なセットアップで実現可能。
- 2D corner cubes made by orthogonal plates, to achieve retroreflection and transparency.



平面ミラーの奇跡：他の可能性は？ Is Flat Mirror Really Miracle?

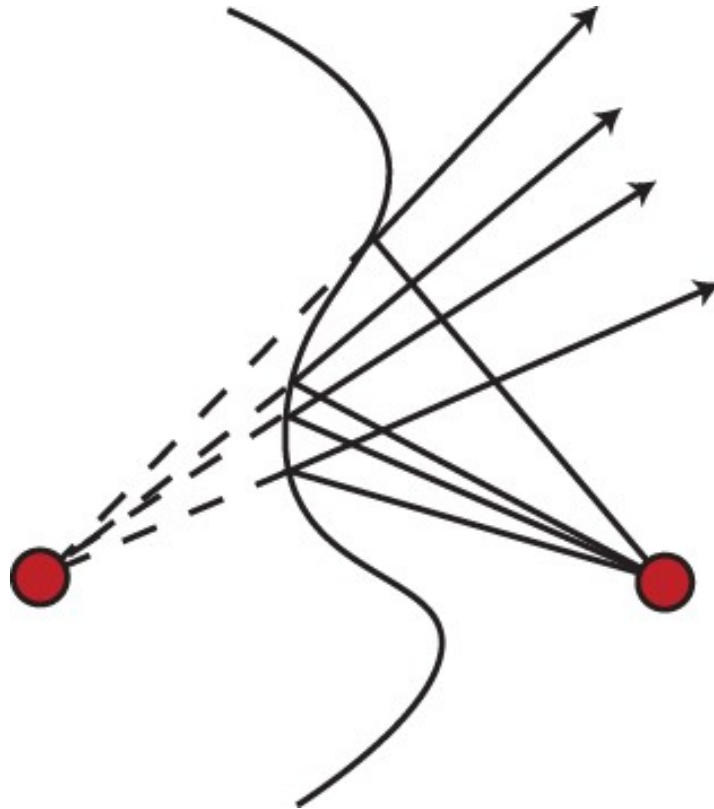

Is there any other surface shape,
that can convert “rays from a point” into
the “rays from a different point”.



橢圓鏡 / Elliptic Mirror

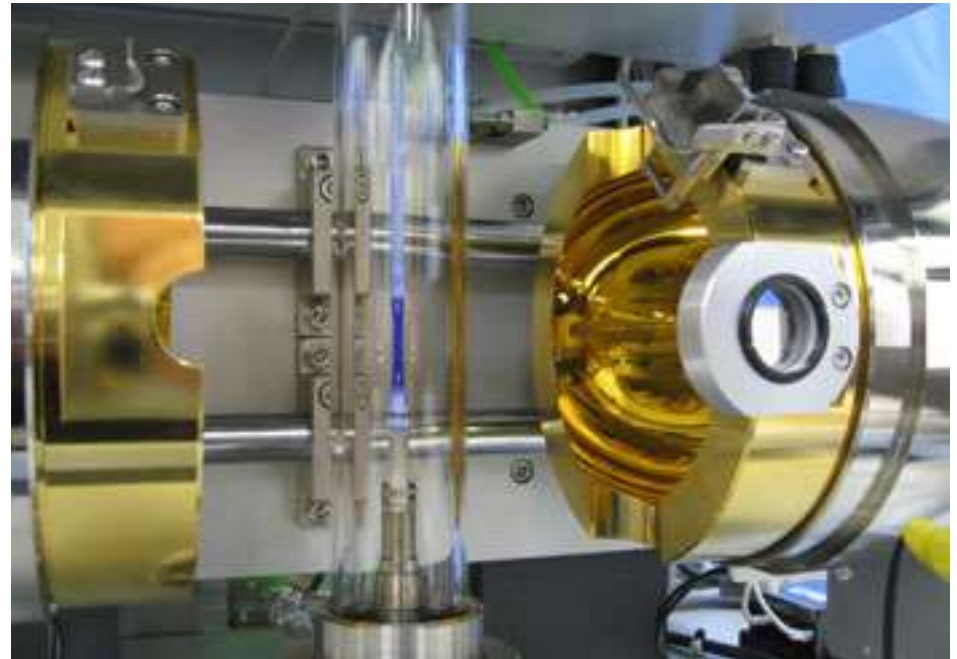
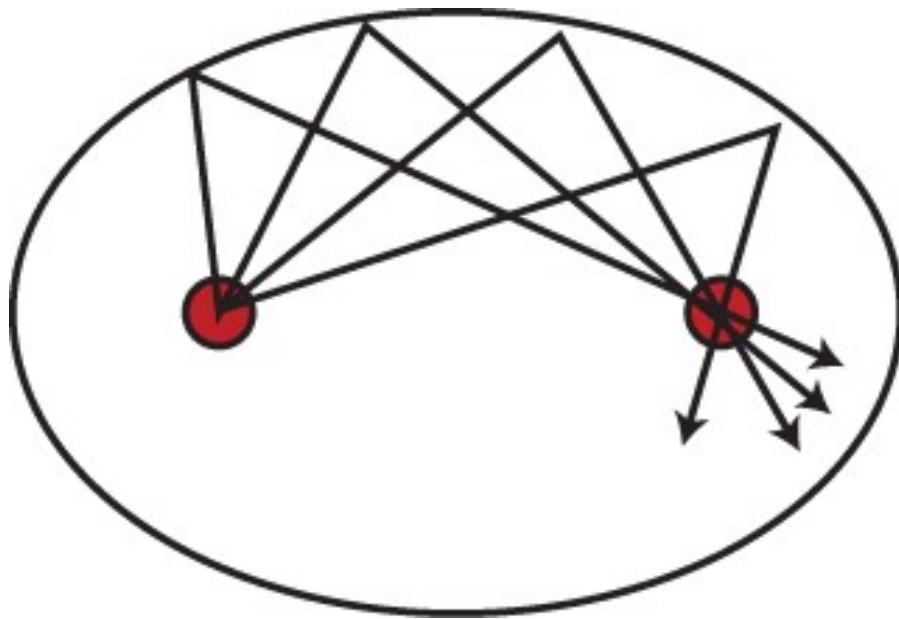

Quantum Design IR Image Furnace

https://www.qdusa.com/products/ir_image_furnace.html

- Generates Real Image
- Used in IR image furnace



双曲面鏡 / Hyperbolic Mirror

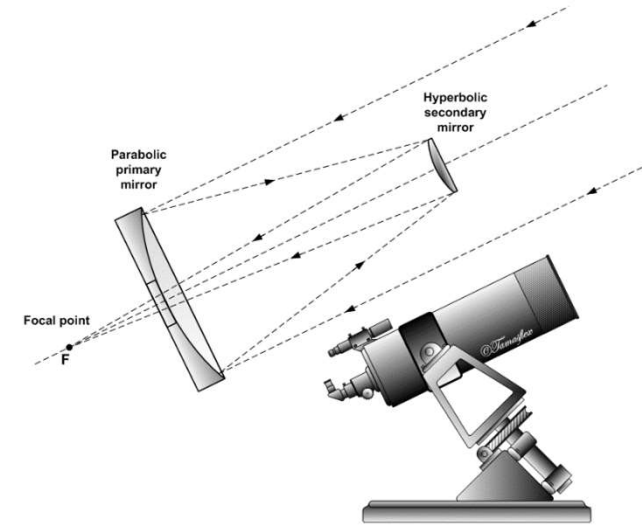
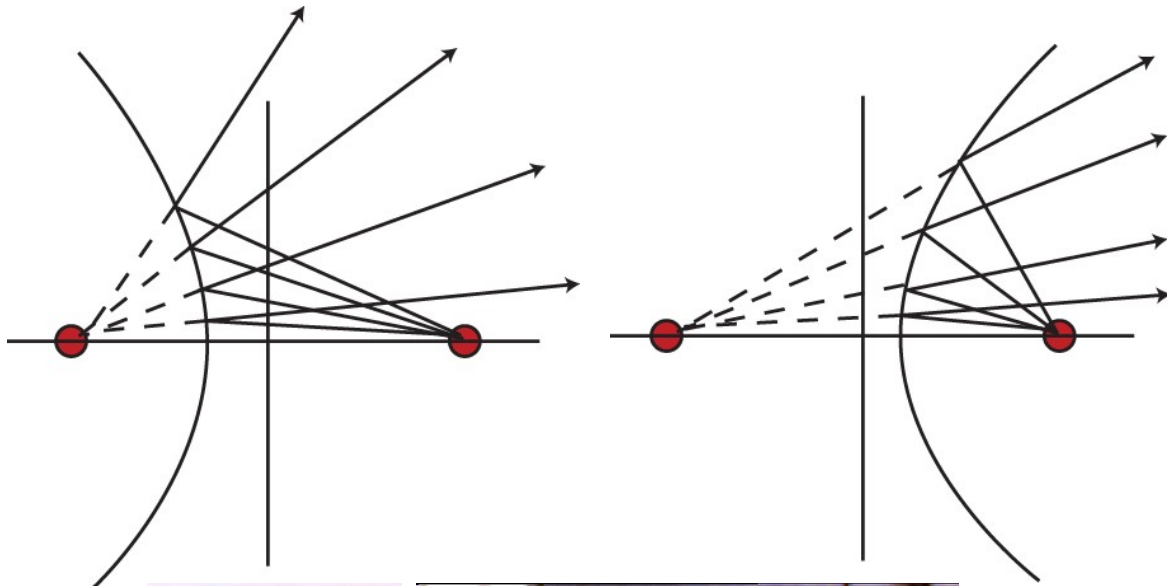

Cassegrain reflector (Wikipedia)
https://en.wikipedia.org/wiki/Cassegrain_reflector



Omnidirectional Vision

<http://cmp.felk.cvut.cz/~svoboda/Demos/Omnivis/>



- Generates Virtual Image.
- Used for secondary mirror for telescope.
- Used for surveillance camera.



放物面鏡 / Parabolic Mirror

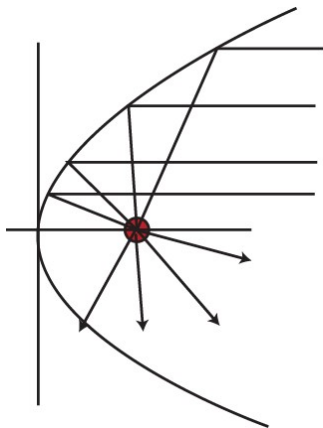
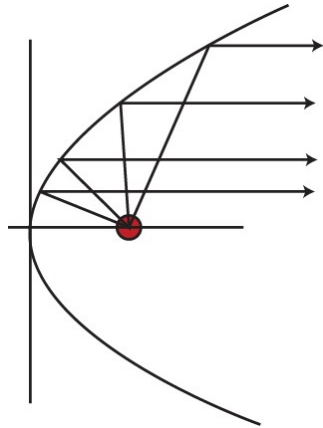

- Converge parallel rays to a focus.
- Change rays from focus to parallel beam and vice versa.



ミラースコープ、マジックスコープ
Mirascope, magic scope

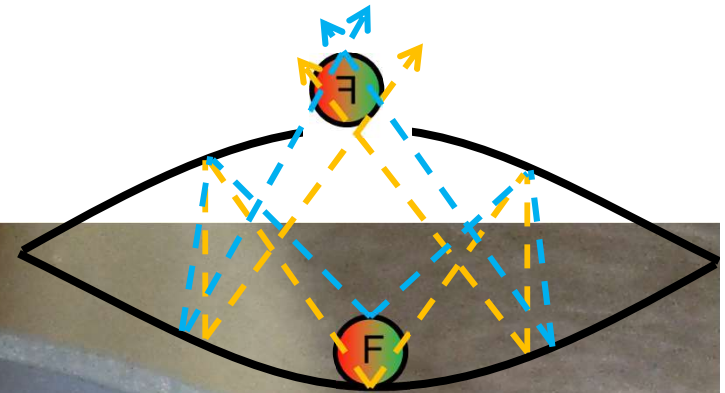

- Two near-parabolic mirrors gives floating real image.



レンズの「像」に戻って / Go back to the lens image

We draw **two representative rays**,
But actually, there are **infinite** number of rays,
and seems as if the rays come out from the image.

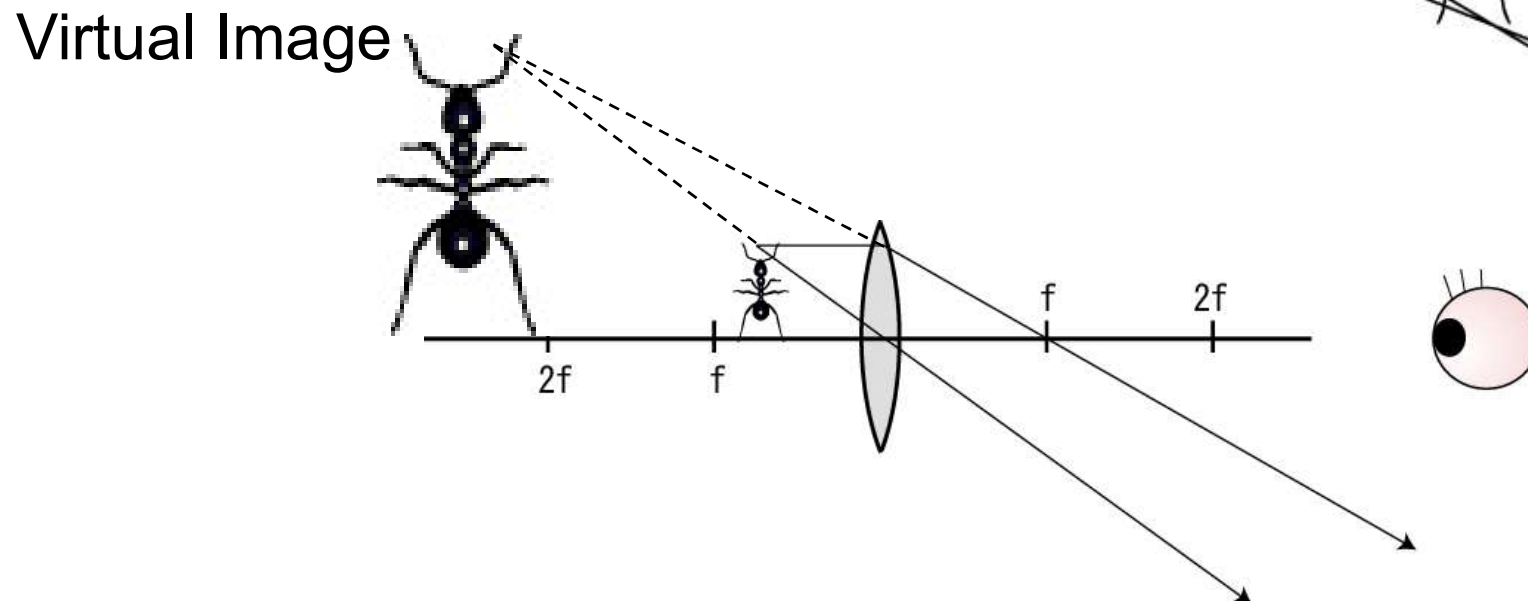
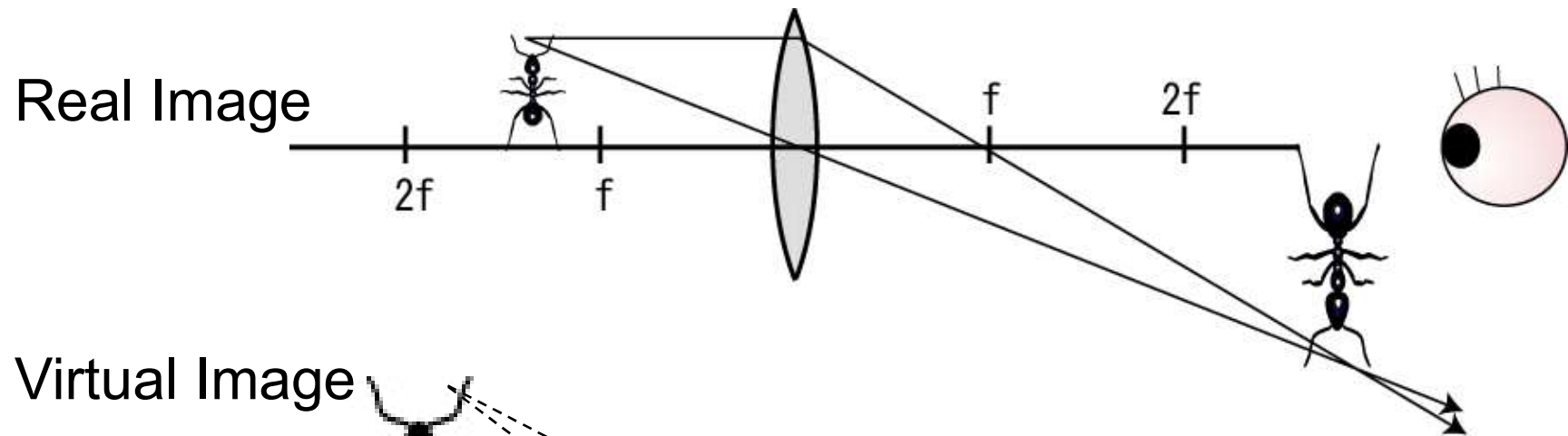

HMDは虫眼鏡／HMD and Magnifying glass

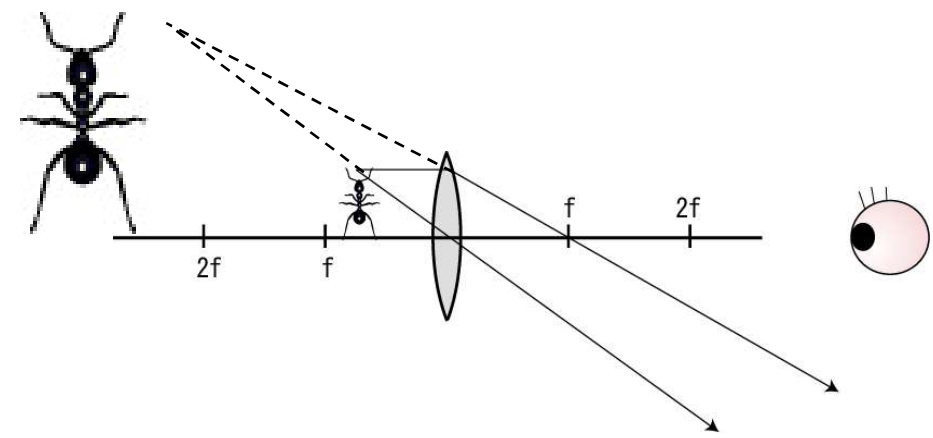

- Head Mounted Display

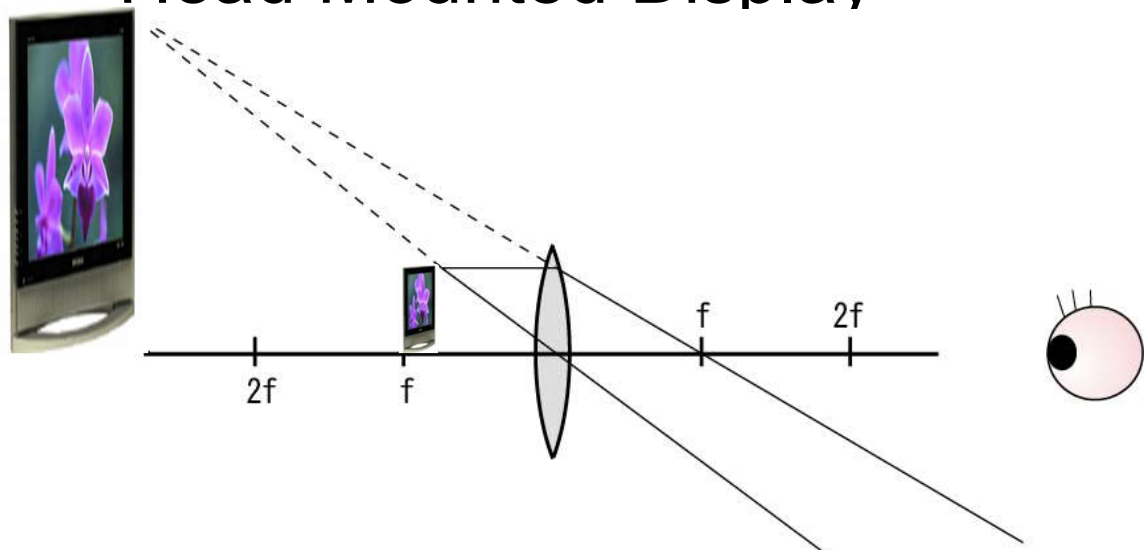

Purpose: change the distance from eye to the image



(復習 / review) 輻輳・調節矛盾 Vergence-accommodation conflicts



- Accommodation & vergence are slightly coupled.
- Stereo display problem:
 - Accommodation = constant
 - Vergence = variable**⇒ Severe Fatigue**

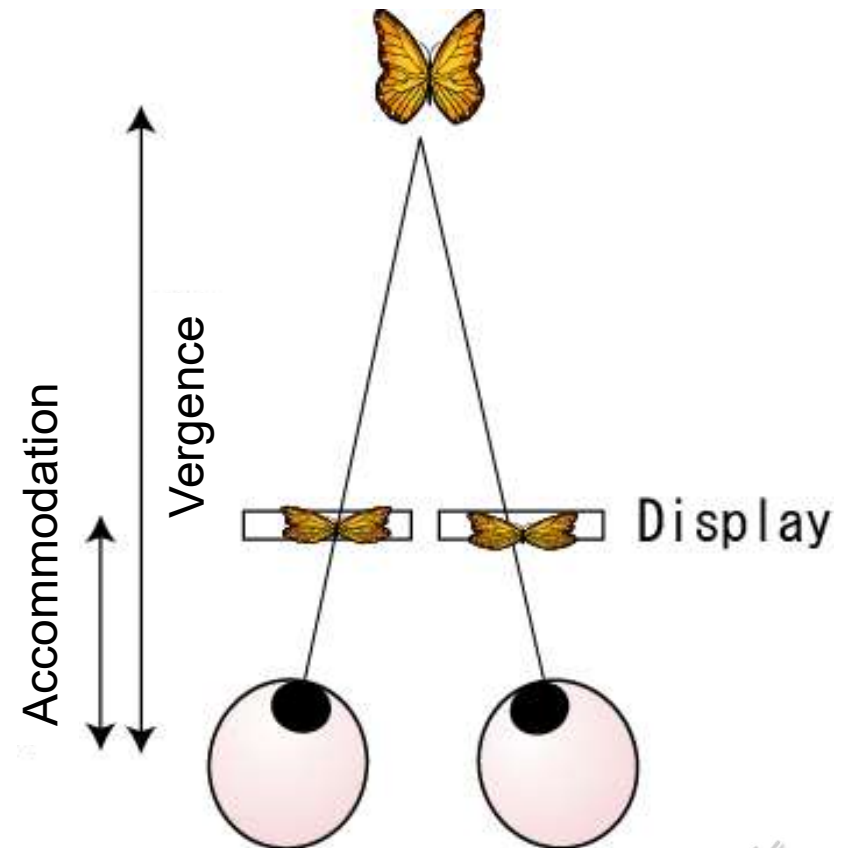

(参考) Zograscope

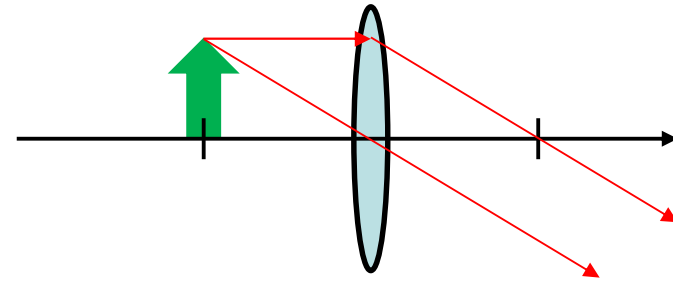

鈴木春信「高野の玉川」1788

<https://en.wikipedia.org/wiki/Zograscope> <https://g.co/arts/r8GnM9QknmewdLAU9>



京洛・中国風景図巻 四条橋芝居
円山応挙宝暦9年(1759)頃

<https://g.co/arts/vwPksWe7W3a15fnV7>

大型凸レンズの焦点付近に絵を置く(鏡を使い、絵は机に置く場合が多い)。光は平行光(コリメート光)となり、遠方からの光に近く、調節による奥行き手がかりが失われる。絵の強調された遠近法と合わせて立体的な風景が感じられる。 Place the picture near the focal point of a large convex lens. The light becomes parallel (collimated), closer to the light from the distance, and depth perception by accommodation becomes impossible. This, together with the emphasized perspective of the picture, gives the impression of a three-dimensional landscape.



望遠鏡／telescope

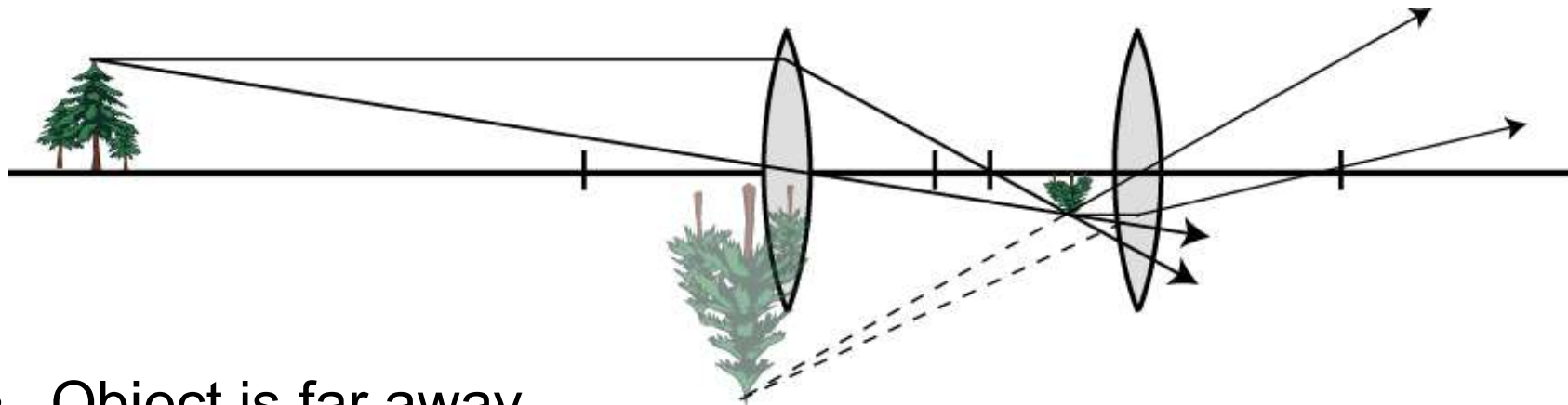

- Object is far away
- Real-image by objective lens (対物レンズ)
- Converted to Virtual-image by ocular lens (接眼レンズ)

- 双眼鏡／binocular glasses

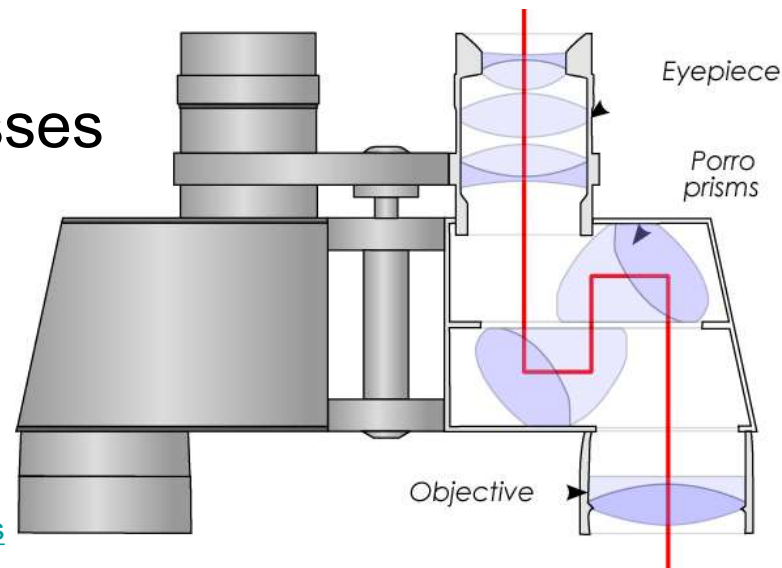

Binoculars (Wikipedia)
<https://en.wikipedia.org/wiki/Binoculars>



測距儀 / Stadimeter

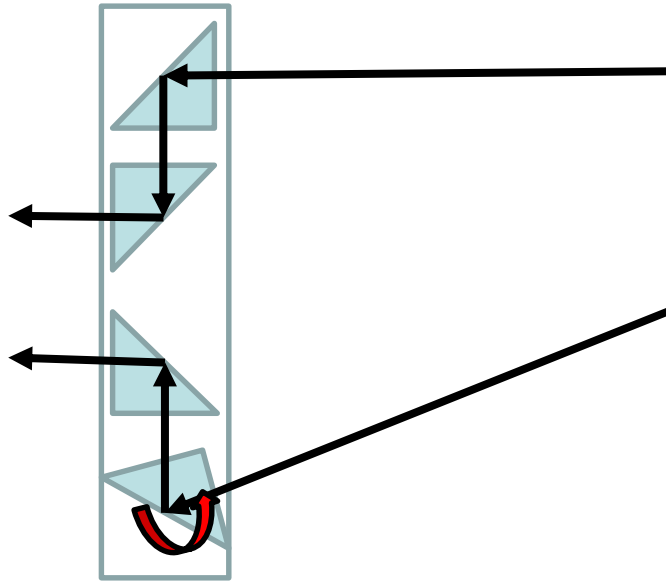

- 片側のミラーを回転、両目映像を重ねる。ミラー回転角度から距離計算。
- 遠い距離だと誤差が大きい(回転角度が非常に小さい)。
- レンズ(望遠鏡光学系)によって距離を等価的に近づける。
- Rotate one mirror to match right and left images. The rotation angle corresponds to distance.
- Lens are used to make optical distance closer.



顯微鏡 / Microscope

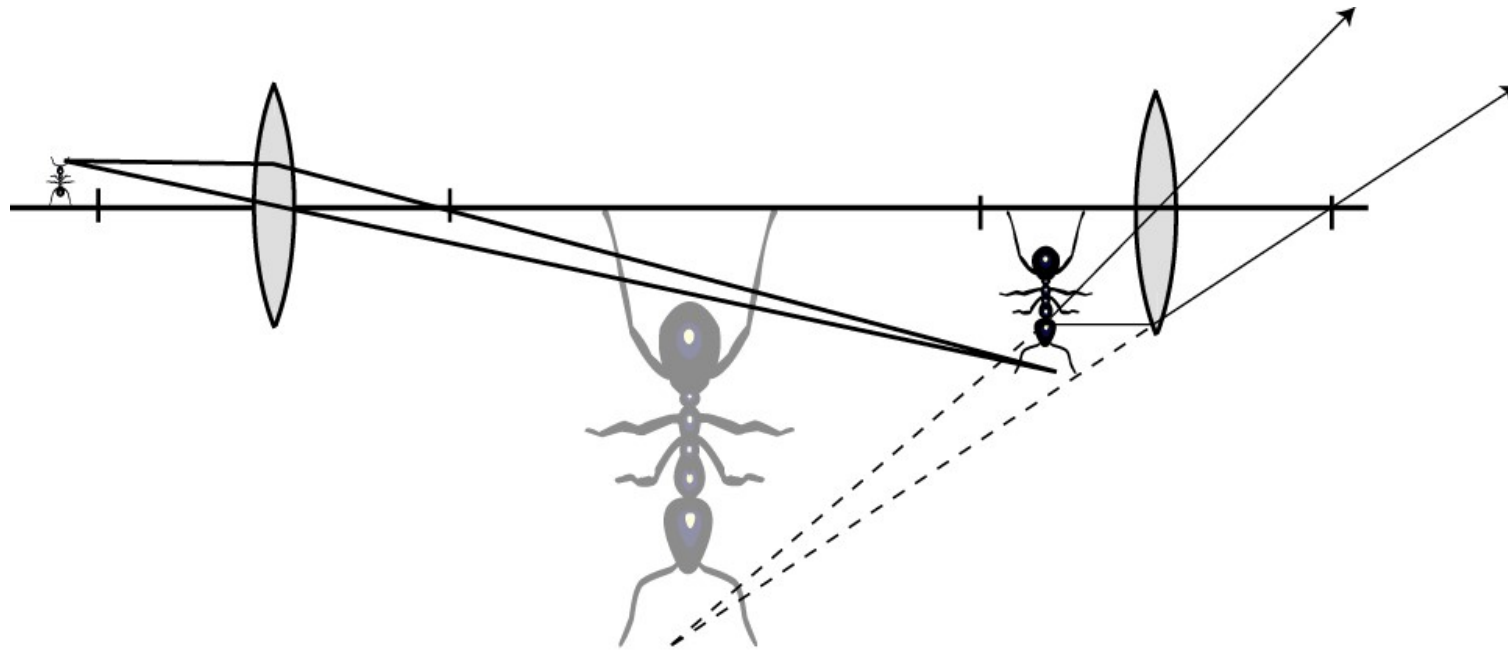

- Object is close to focus of objective lens.



被写界深度／Depth of Field



- 左: 被写界深度が浅い／Left: Shallow (F2)
- 右: 被写界深度が深い／Right: Deep (F11)



被写界深度／Depth of Field

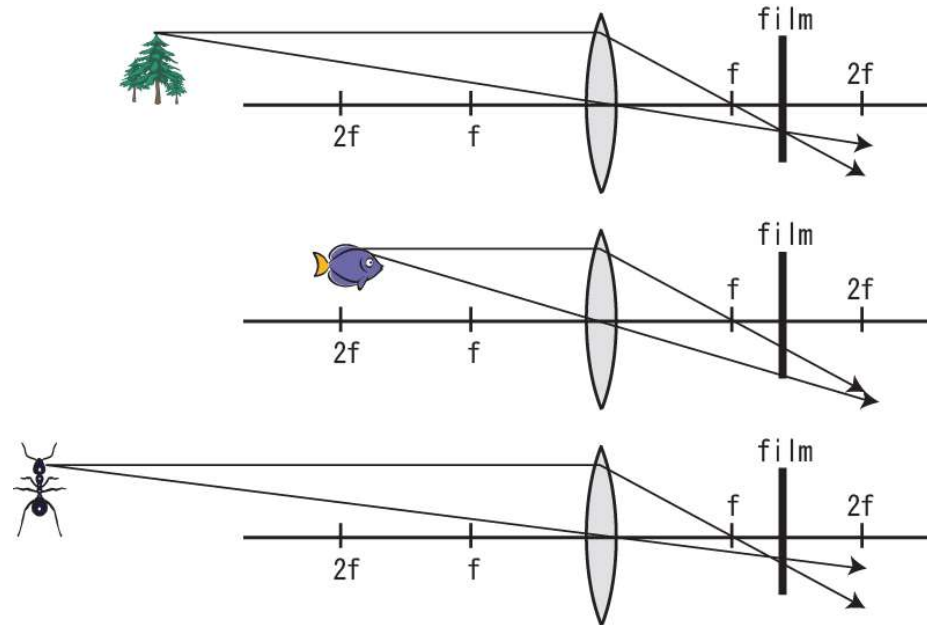

- 焦点の合う距離は一つだけ。他の距離ではすべてボケる。
When distance between lens and film is fixed, object distance is fixed. Other objects always blur.
- しかし、ボケが人間に判別できないレベルの範囲であれば許容できる⇒この許容範囲のことを被写界深度と呼ぶ。
Depth of Field=Acceptable distance



被写界深度／Depth of Field

- 被写界深度は、絞りと焦点距離に依存
 - Depth of field is related to aperture & focal length
- 絞り／Aperature (=レンズの実質的な大きさ/lens size)
 - Large aperature = Shallower Depth of Field
 - Minimum Aperature = Pinhole Camera
 - 応用: 視力の良くなるアイマスク

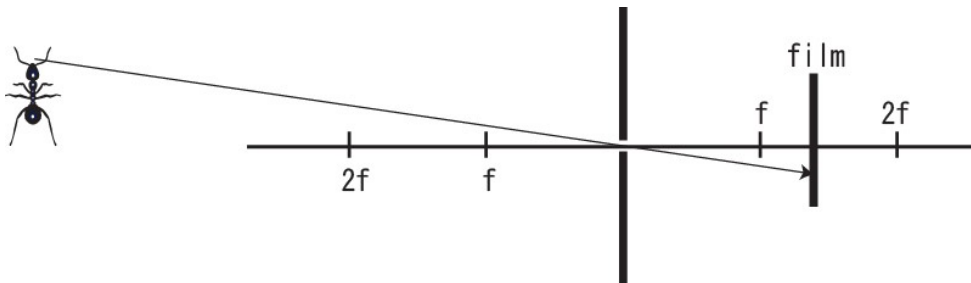

- 焦点距離／Focal Length
 - 短い(=広角)ほど深い(極端な例: 魚眼レンズ)

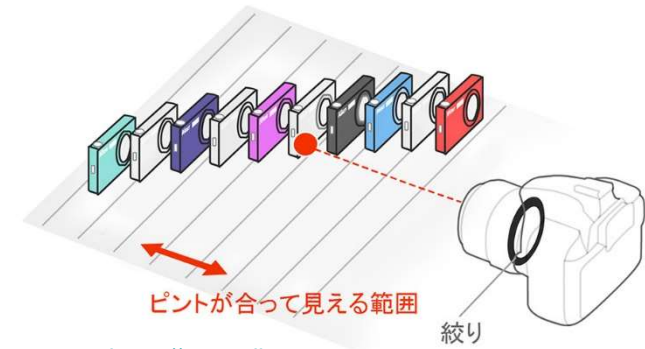
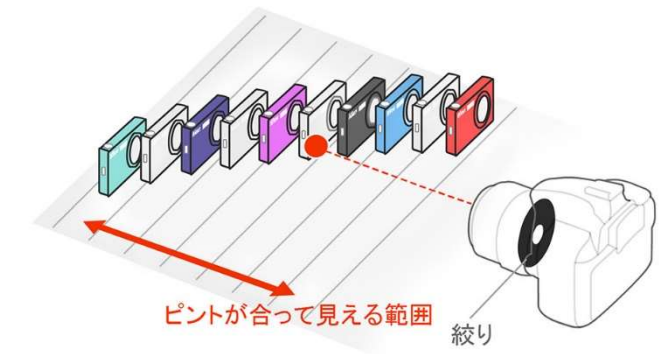

<https://www.nikon-image.com/enjoy/phototech/manual/04/04.html>



ピンホール＝被写界深度無限

Pinhole makes the depth much larger.



- (左)普通に撮影(スマートフォン)/ Photo by ordinary smartphone.
- (中)アルミホイル+穴でピンホール化 / Pinhole by aluminum foil.
- (右)遠くも近くもピントが合った写真に/ Photo again.



被写界深度:コンパクトカメラの大問題

Depth of field as an issue of compact-size camera.



- レンズが小さい=ピンホールに近い=被写界深度を浅く出来ない。
- Small lens = close to pinhole = shallow depth is difficult.



被写界深度・焦点の「後処理」 / Synthetic Refocusing

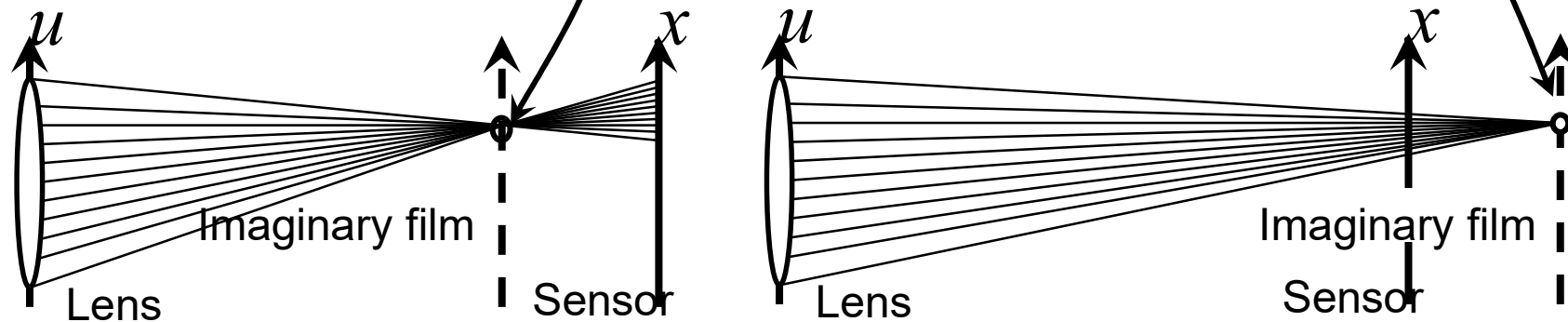

<https://www.lytro.com/renng-thesis.pdf>

- 到来する光線を方向も含めて記録できればピントを合わせる距離の後処理可能
- If incident light “direction” is recorded, refocusing after the shoot is possible.



Synthetic Refocusing (idea)

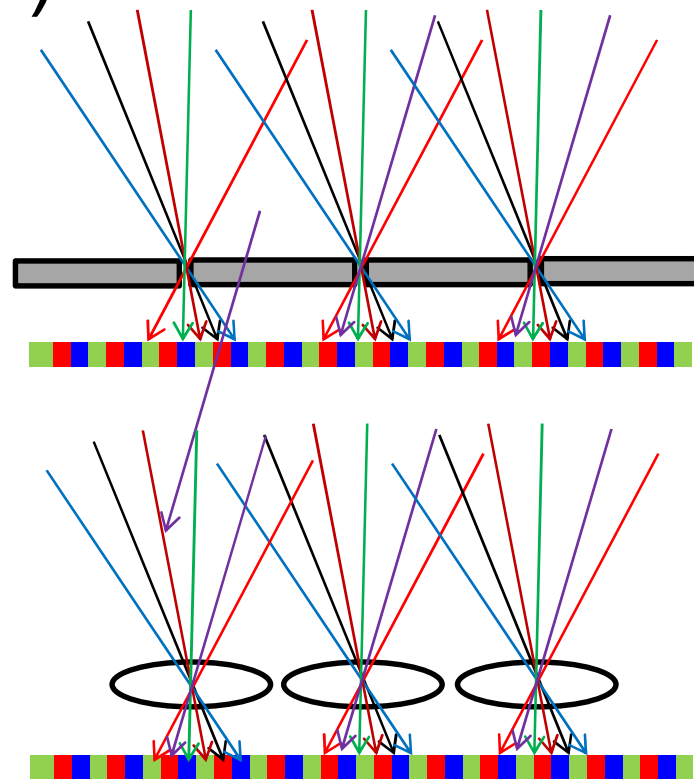
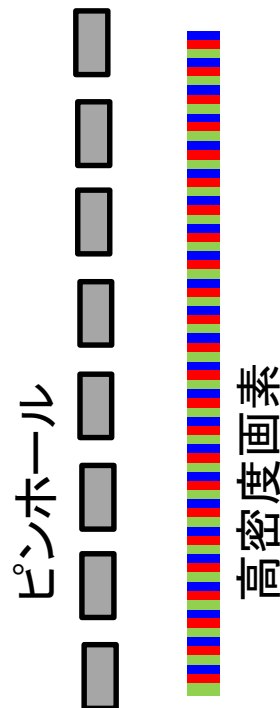

ピンホール(個数=実現すべき画素数) + より高密度な画素で「方向も含めた」光線群を記録。 / Pinhole + high-resolution sensors can record incident light and its direction.

- 実際には多数のレンズを用いる。 / Normally micro lens are used.
- 複数のカメラで実現等、多くのバリエーション。 / Multiple cameras are also used.

製品 : Lytro(2012)

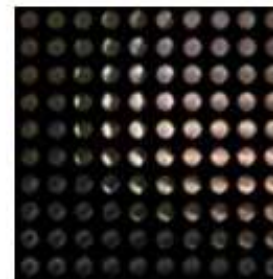
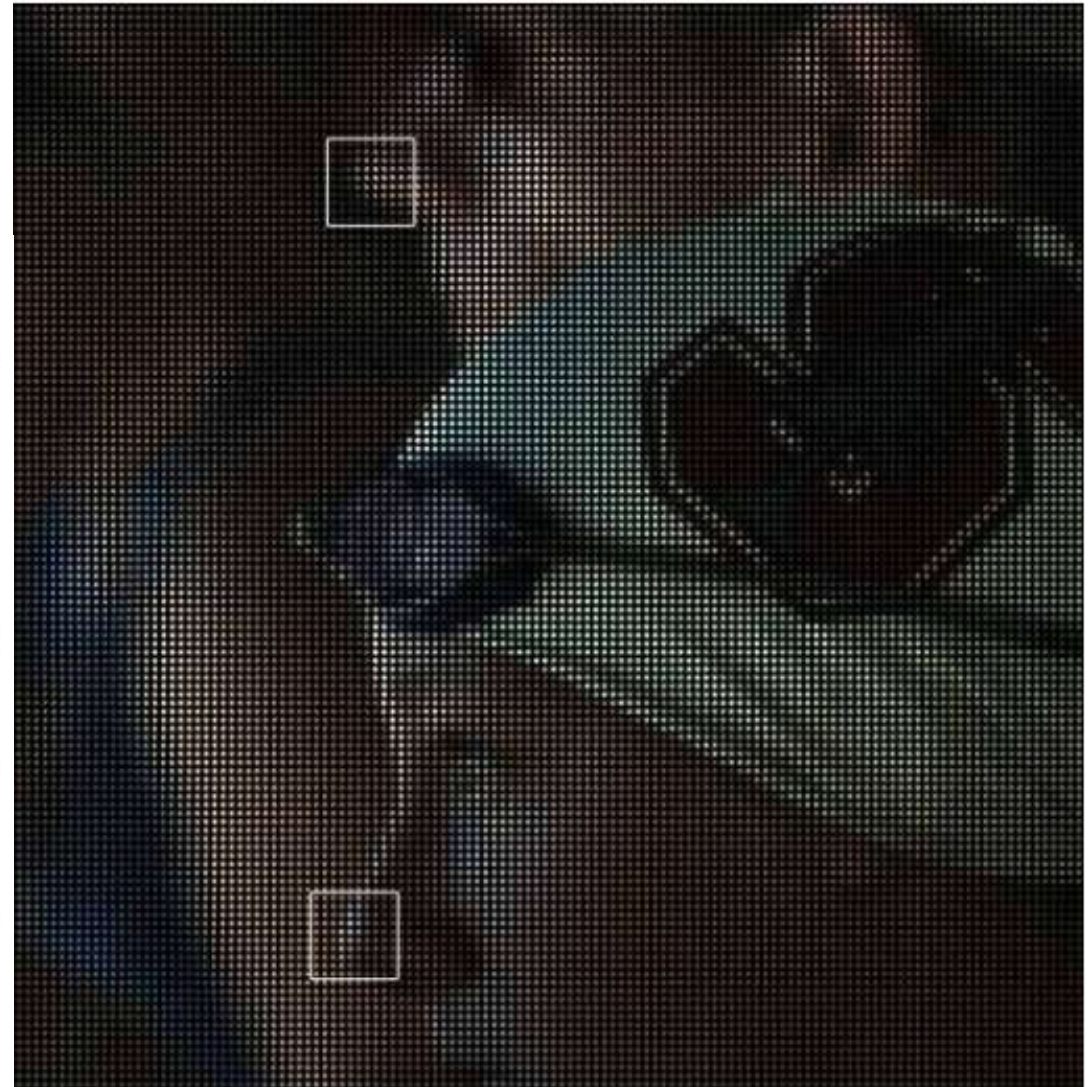
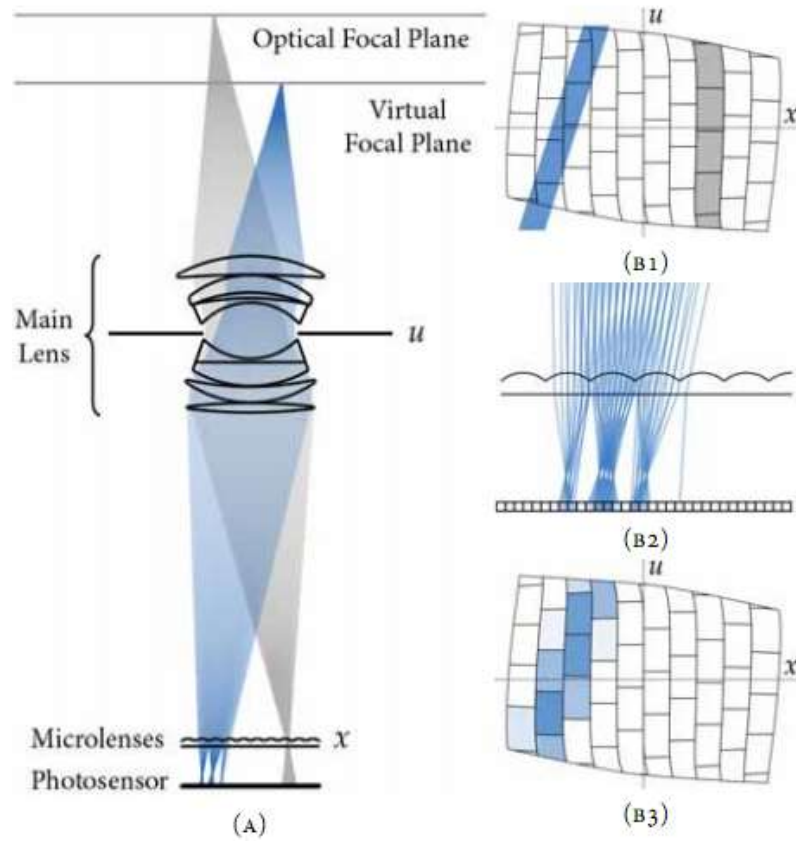

(Z1)

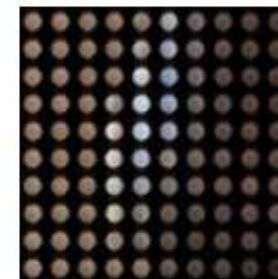

(Z2)

<https://www.lytro.com/renng-thesis.pdf>



製品 : Lytro(2012)



Lytro Illum review

<https://www.youtube.com/watch?v=bUd7xXhmugM>



屈折率、曲率と焦点距離／

Refraction factor, curvature and focal length

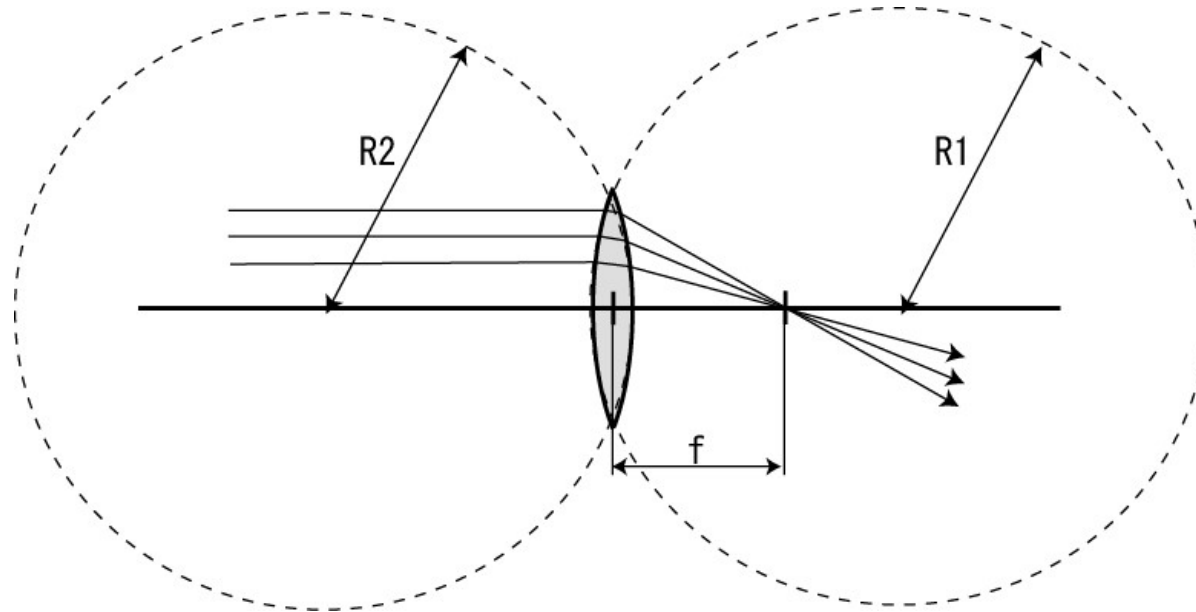

- 球面レンズの場合の近似式／For spherical lens

$$\frac{1}{f} = (N - 1) \left(\frac{1}{R_1} + \frac{1}{R_2} \right) - \frac{(N - 1)^2 d}{NR_1 R_2}$$

- f :焦点距離, N :ガラスの屈折率, R_1, R_2 :レンズの曲率半径, d :レンズの厚み
- 薄いレンズでは第二項は無視することが多い。



What happens if N=2 ?

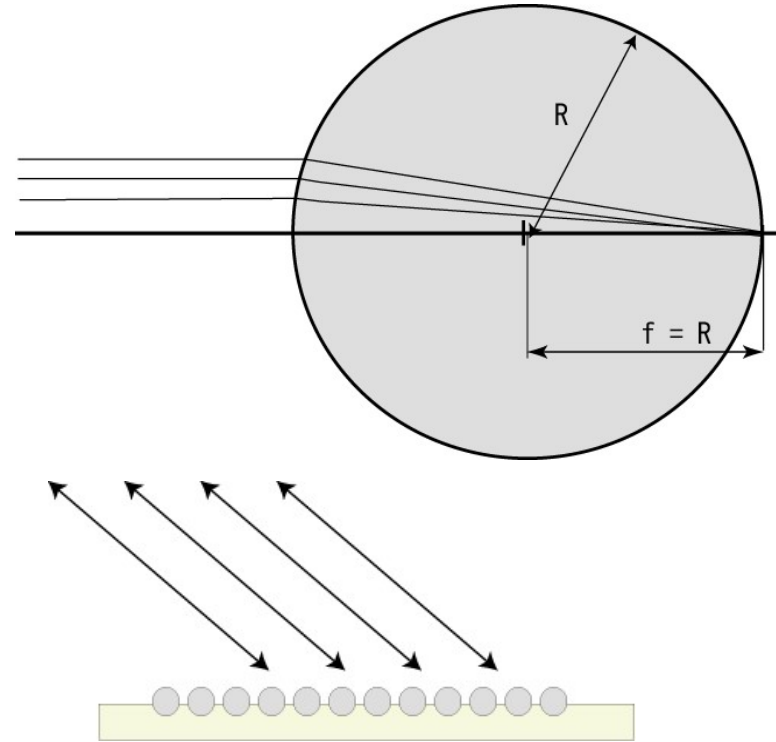
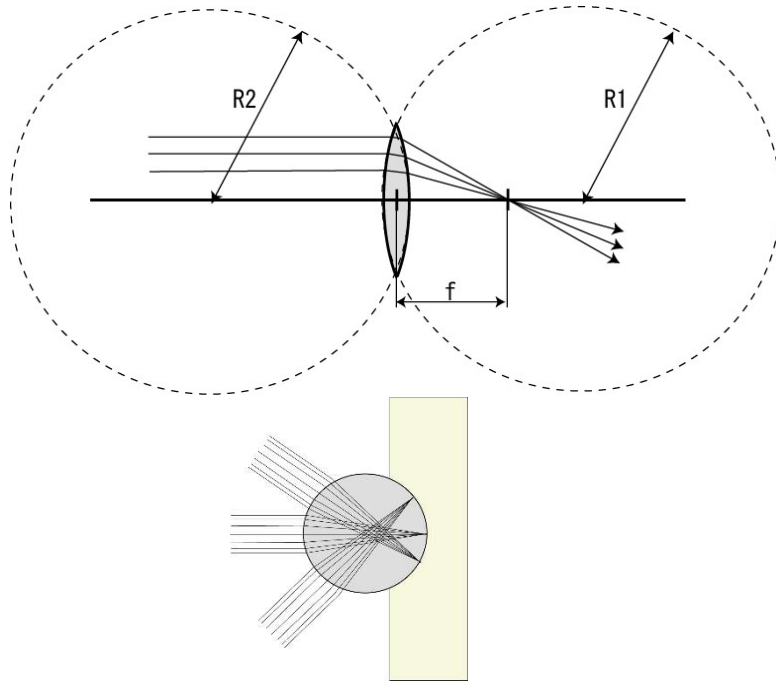

- $N=2$, $R_1=R_2=R$, $d=2R$ を代入

$$\frac{1}{f} = (N-1) \left(\frac{1}{R_1} + \frac{1}{R_2} \right) - \frac{(N-1)^2 d}{NR_1 R_2} = (2-1) \left(\frac{1}{R} + \frac{1}{R} \right) - \frac{(2-1)^2 2R}{2R^2} = \frac{1}{R}$$

$$\therefore f = R$$

- 球面の反対側表面に焦点を結ぶことを意味する
- Meaning focal point is just at the back side of the lens



再帰性反射材／Retro-reflector

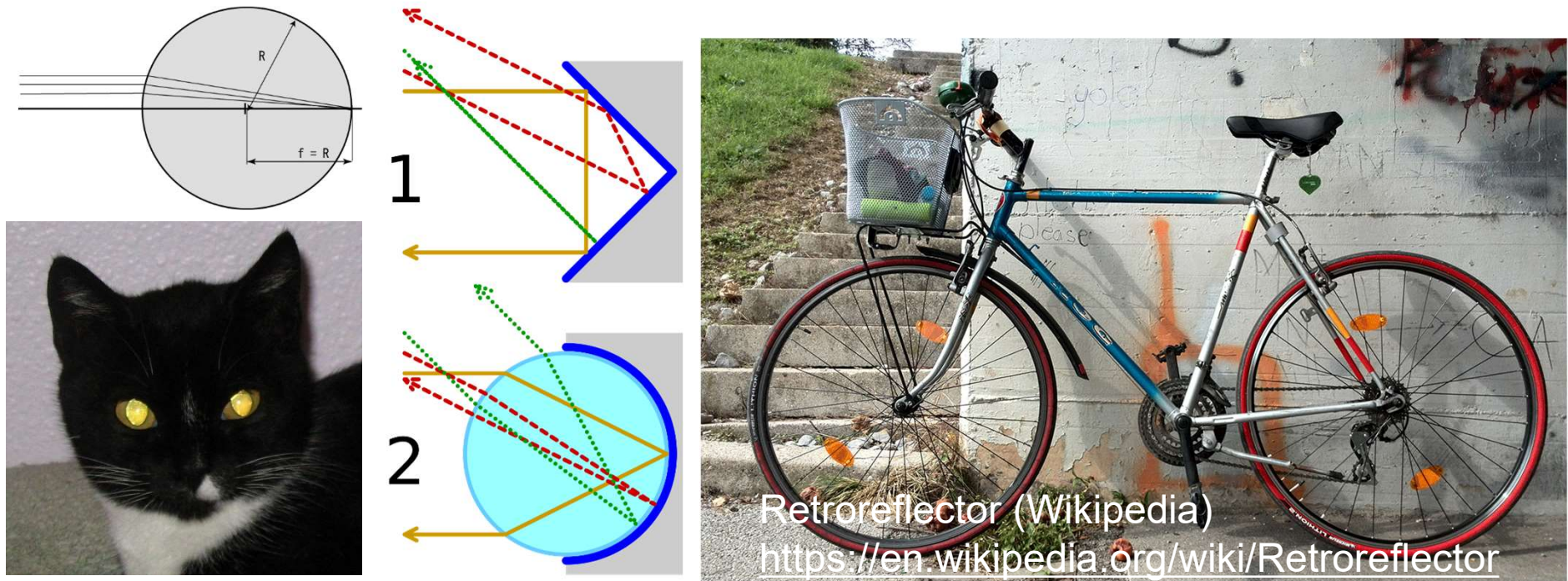

- 屈折率2のガラスビーズは、光が来た方向に帰る
glass beads with refractive index=2 works as retro-reflector.
 - 球面内側表面での「鏡面」反射は本質ではない。拡散反射しても再帰性反射は生じる(赤目現象と同じ。当然鏡面反射の方が強い反射光を得られるが)
- コーナーキューブタイプも多用される。
Corner cube is also used.



再帰性反射材 / Retro-reflector

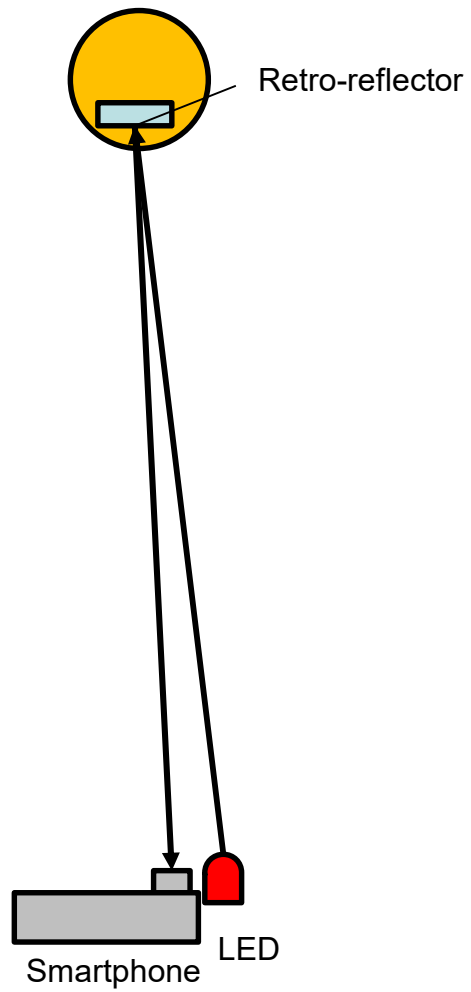

公園/park

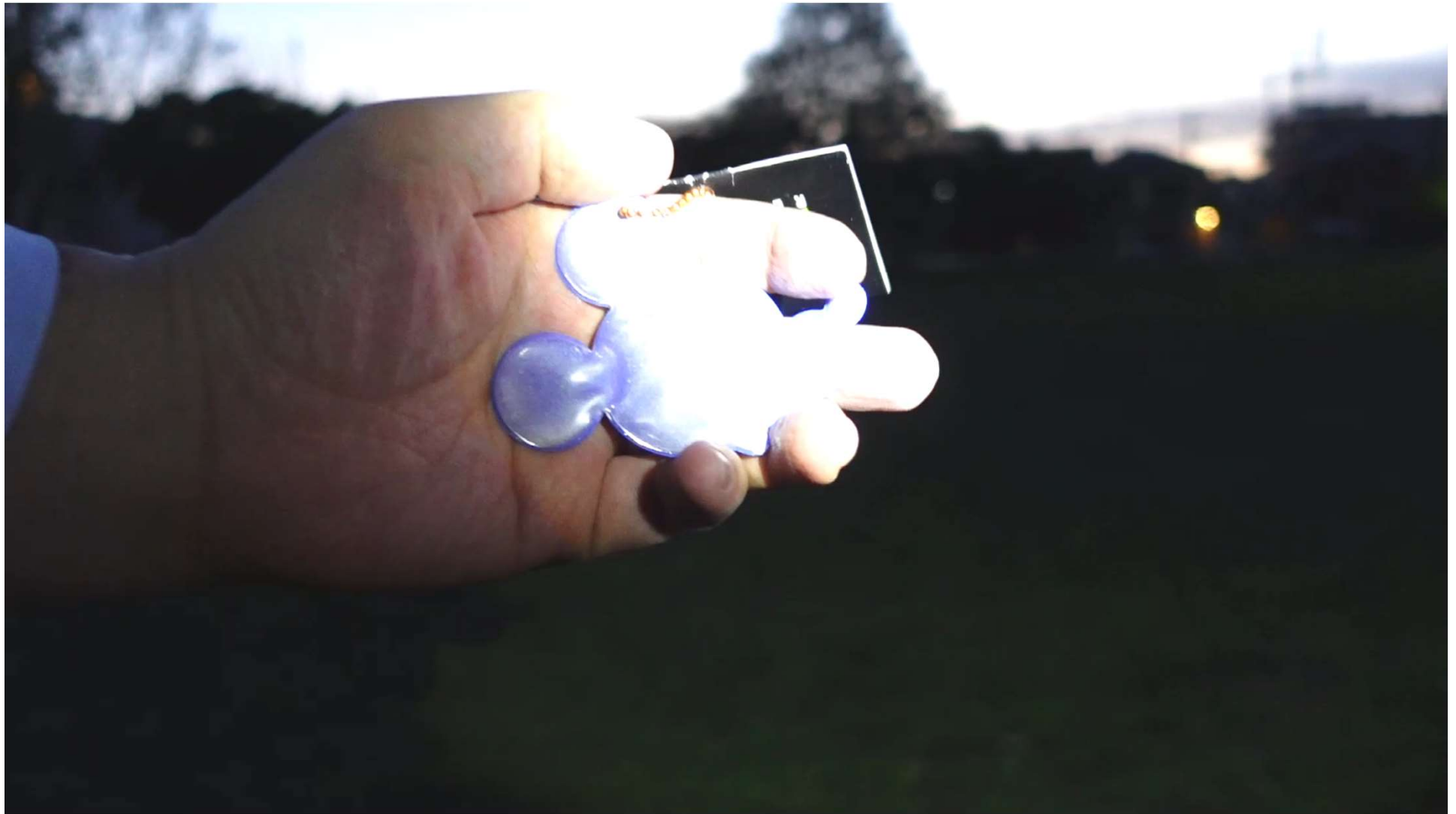

月/moon

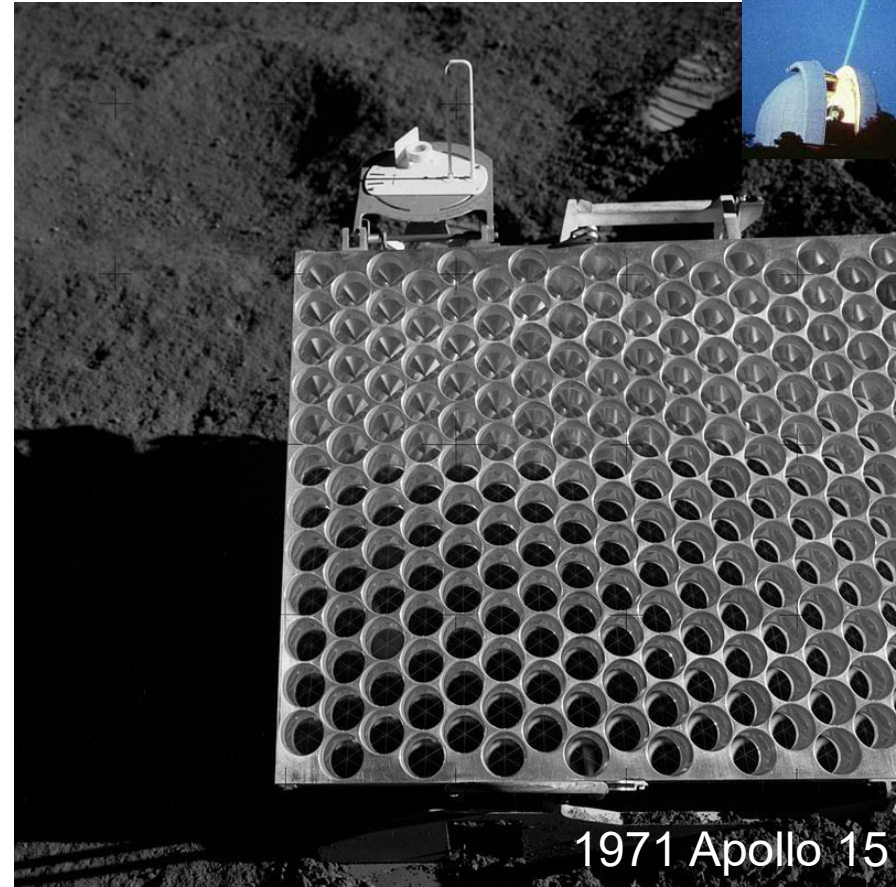

https://en.wikipedia.org/wiki/Lunar_Laser_Ranging_experiment

- 再帰性反射材(コーナーキューブ)により月までの距離を正確に計測。
- The retroreflective material accurately measures the distance to the moon.



ルネベルグレンズアンテナ/ Luneburg Lens Antenna

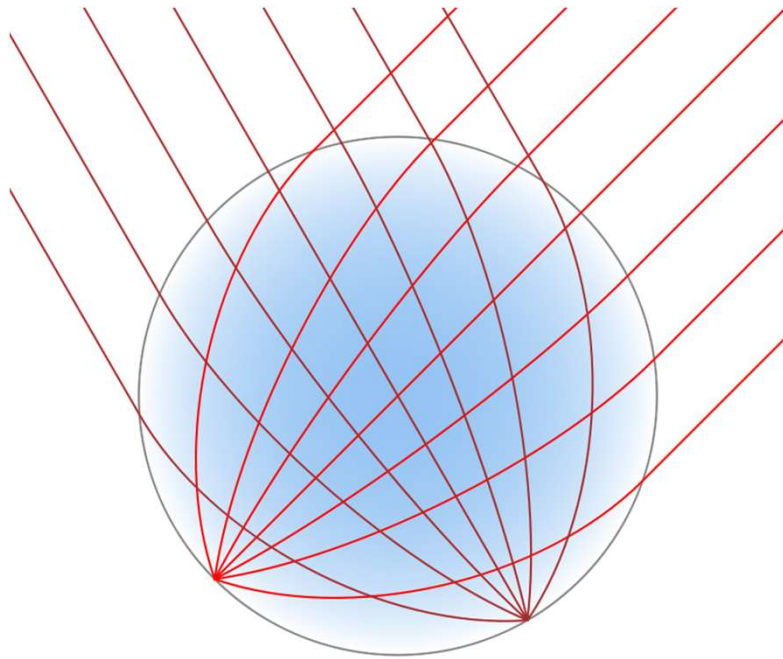

https://en.wikipedia.org/wiki/Luneburg_lens

- 球の中心から表面へ勾配をかけた屈折率によって理想的な再帰性反射が可能。
- ルネベルグレンズと呼ばれ、電波領域ではアンテナとして利用される。パラボラと違いフィーダのみ動かせば良い。
- 音響のルネベルグレンズも提案多。コーナーキューブによる音や熱の再帰反射も
- The refractive index, which is graded from the center of the sphere to the surface, allows for perfect retroreflection. In the radio domain, it is called a Luneburg lens and is used as an antenna. Unlike parabolas, only the feeder needs to be moved. A number of acoustic Luneburg lenses have also been proposed.



再帰性反射現象としての虹/ Rainbow as a retroreflective phenomenon

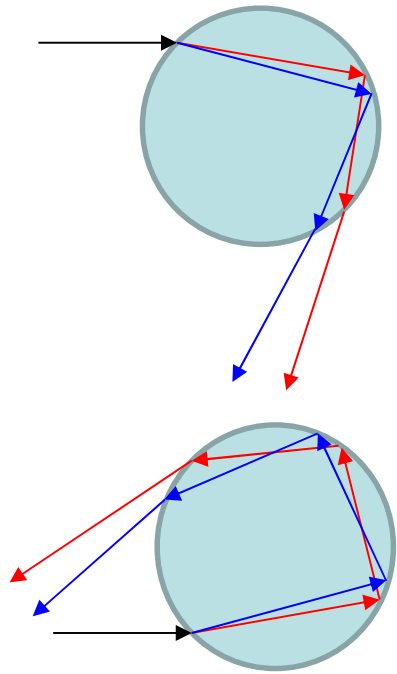

- 雨粒の不完全な再帰性反射の際に色ごとの屈折率の違いが色のついた円環として観察される現象。反射回数の1回多い副虹が観察されることも。
- 単体の雨粒では虹は理解できず、無数の雨粒が空間に存在していることをイメージする必要。
- 原理的に必ず太陽を背にして発生する。
- A phenomenon in which the different refractive indices of different colors are observed as colored circles during imperfect retroreflections of raindrops. A secondary rainbow with one more reflection can also be observed. A single raindrop is not enough to understand a rainbow, you need to imagine that there are countless raindrops in the space.

(CHI2021) Vibrosight++: City-Scale Sensing Using Existing Retroreflective Signs and Markers
Yang Zhang, Sven Mayer, Jesse T Gonzalez, Chris Harrison

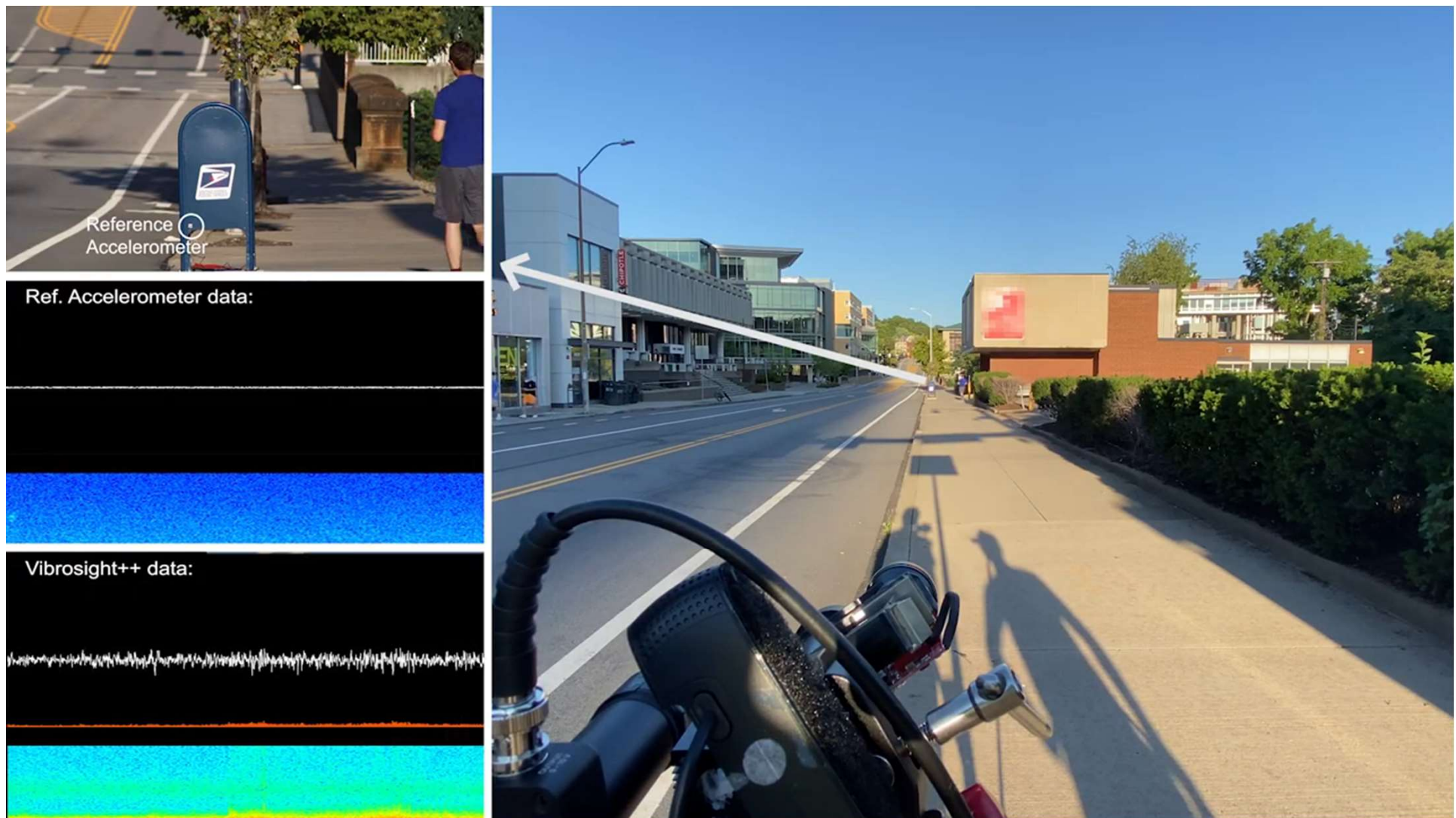

<https://www.youtube.com/watch?v=zbMOT1XsLZE&list=PLqhXYFYmZ-Vdsg4-okDWnptnyAs8HXjfN&index=12>

- 街中にある再帰性反射材+レーザーで振動検出

TODAY's TOPIC



- 光学素子 / Optical Elements
- 光学の基礎 / Basics of Optics
- 3次元イメージング / 3D Image Sensing



3次元イメージング / 3D Image Sensing

- 3D Display requires 3D data acquisition
 - 視差、見え方の変化の利用 / disparity & change of image
 - モワレ法 / Moire Fringe Analysis
 - 光切断法 / Light Section
 - パッシブステレオ法 / Passive Stereo
 - 視体積交差法 / Visual Cone Intersection
 - 照度差ステレオ法 / Photometric Stereo
 - レンズ焦点法 / Shape from Focus
 - 時間差の利用 / time of flight
 - direct Time of Flight (dToF)
 - indirect Time of Flight (iToF)



モワレ法 / Moire Fringe Analysis



- Project stripes
- See the projected image through the other stripes
(do the same calculation in PC)
- Depth is converted to density.

Observation

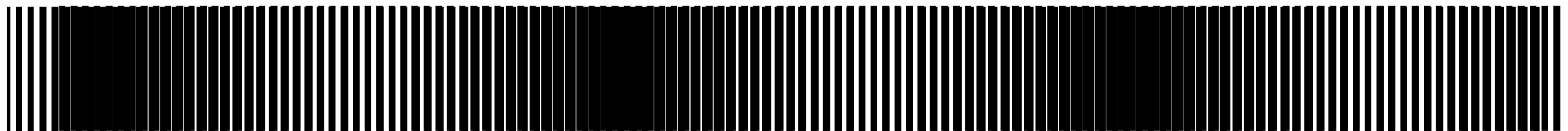

Projection

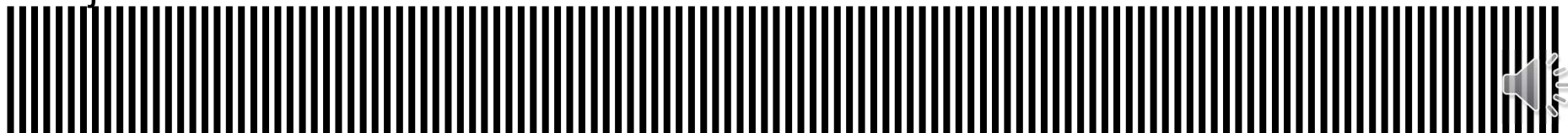

(UIST2021)MoiréBoard: A Stable, Accurate and Low-cost Camera Tracking Method Chang Xiao, Changxi Zheng

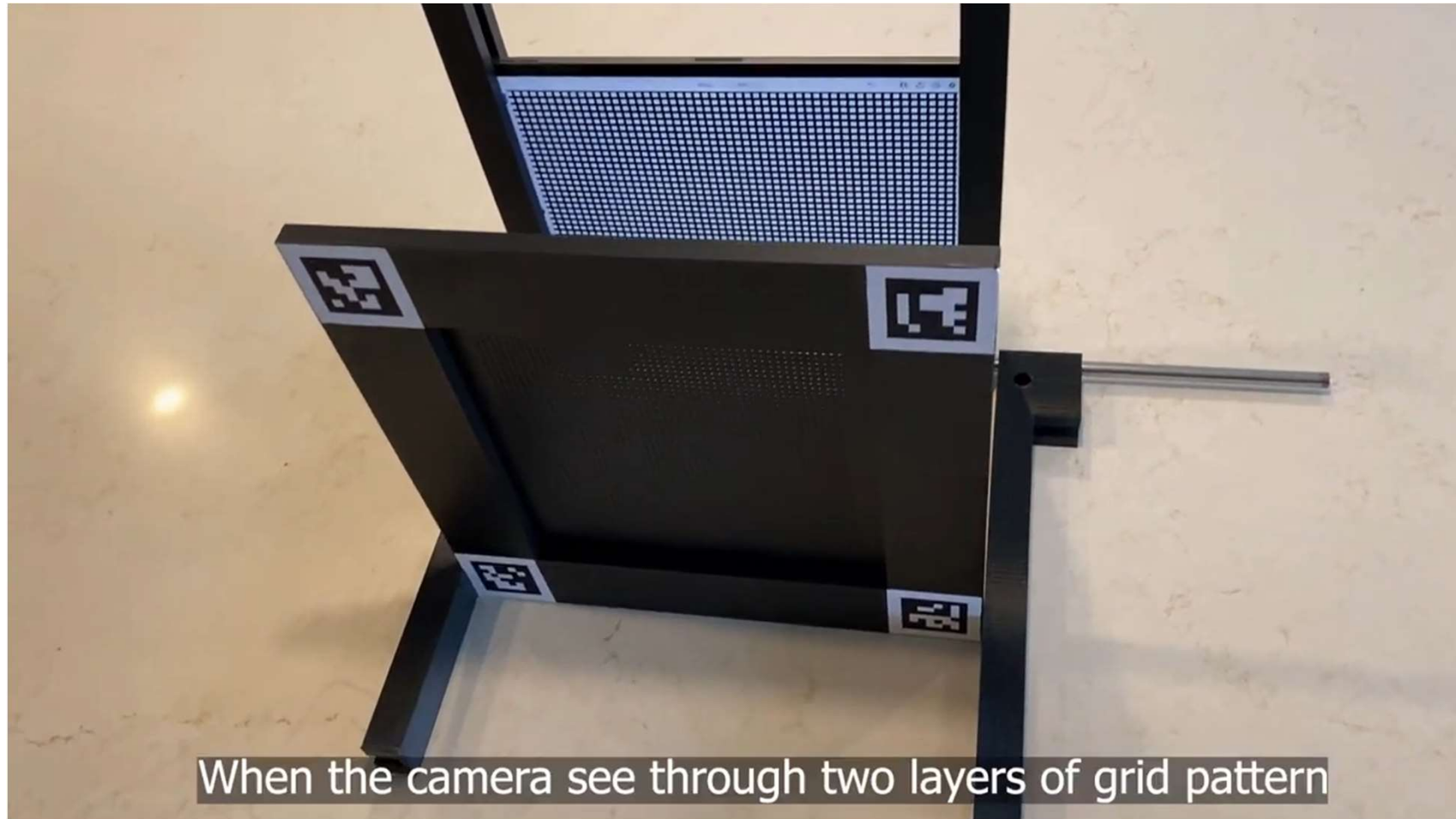

通常のARマーカ―とモワレ縞を組み合わせることで低コストに位置トラッキング
<https://www.youtube.com/watch?v=u0bPYICHOkE&list=PLqhXYFYmZ-VeKUIuttbQWomTQ-oXF6PLf&index=93>

光切断法 / Light-section method

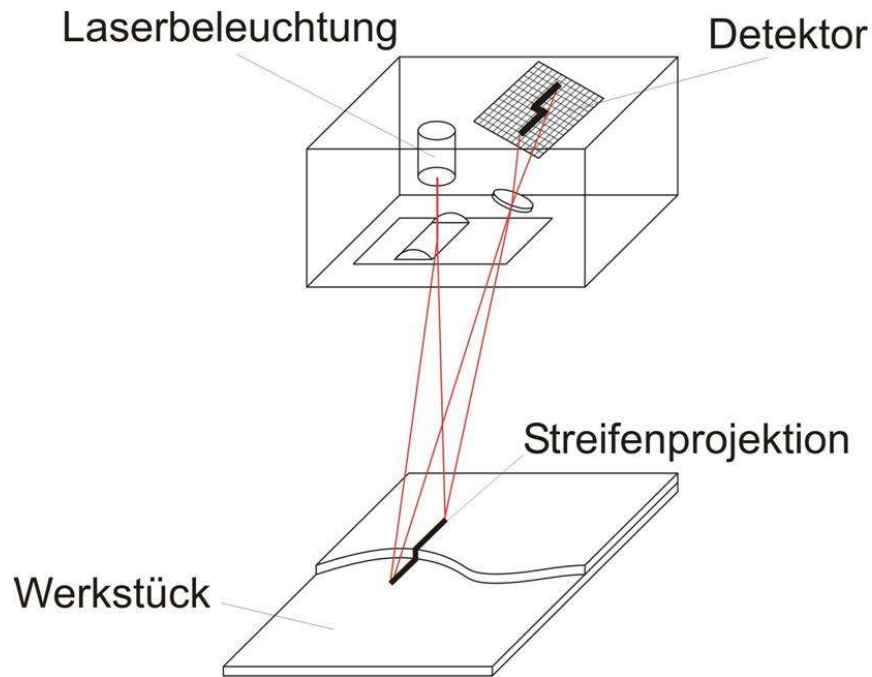

Light section (Wikipedia)
https://en.wikipedia.org/wiki/Light_section

Inline Color 3D Scanner Light Section Method
<https://www.youtube.com/watch?v=dd3ayqJGVvo>
カラー光切断法
<https://www.youtube.com/watch?v=dN3lxPWgCzc>



- Project line image and Capture from different position.
- Disparity = distance
- Coded pattern is projected for fast acquisition.



Real-time Projection & 3D retrieval (Song Zhang et al., 2006)

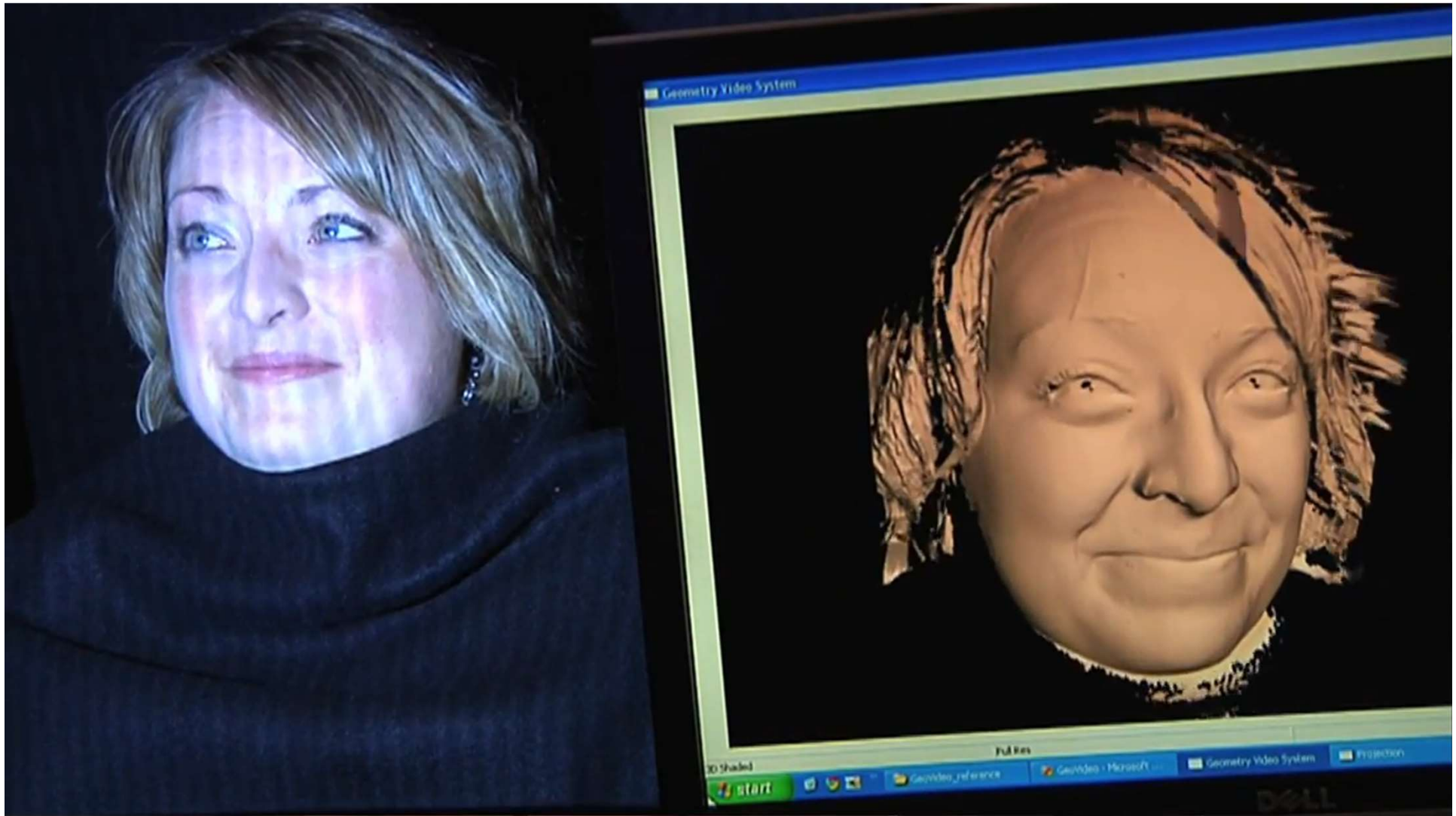

<https://www.youtube.com/watch?v=83WwqWiqCmc>

Note: stripe-pattern projection method was devised *before* video projector became common.



3D Scanners are Cheap now

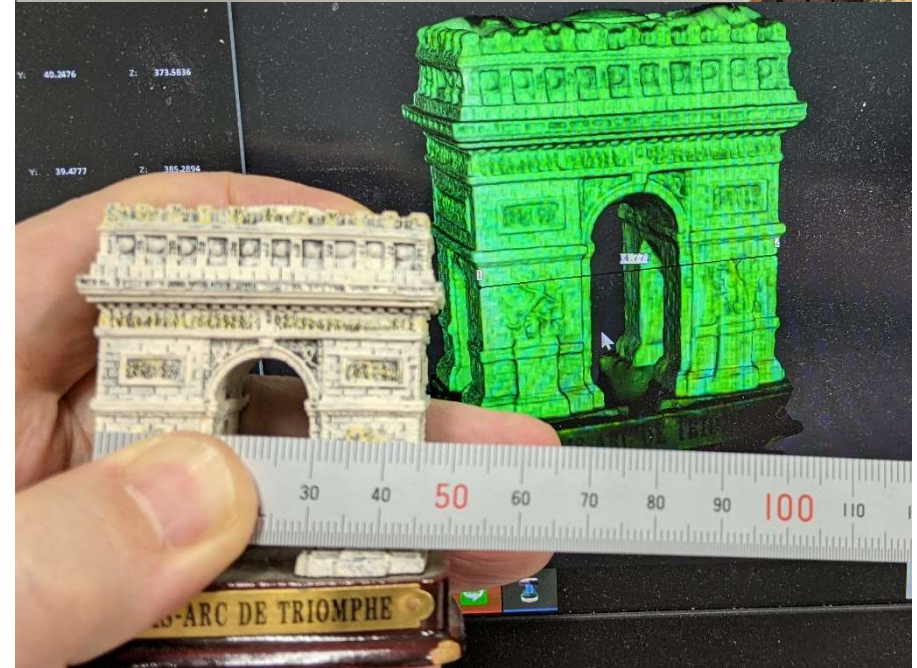
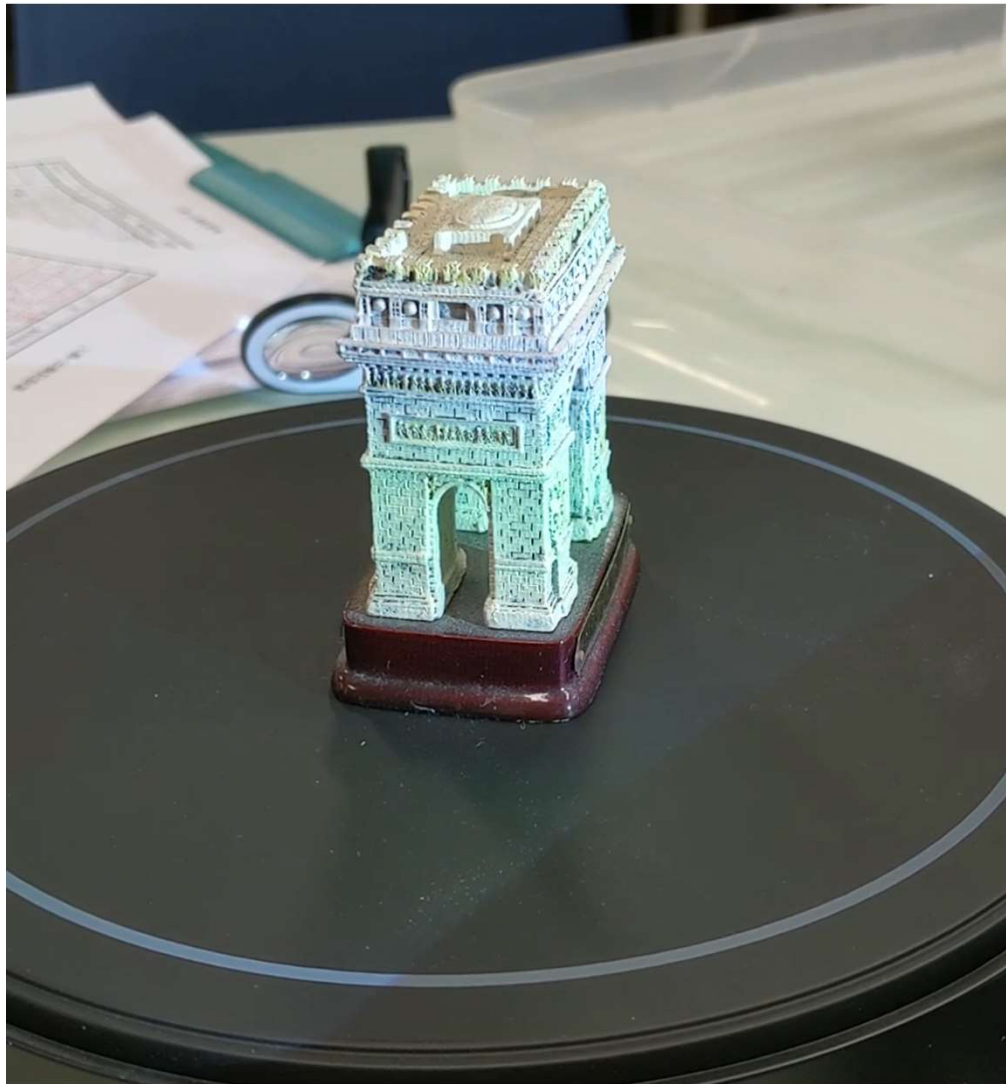

EinScan SE

Projector + 2 cameras + turnable table



Xbox Kinect (ver.1) (2012) Projection pattern



Kinect v1 (Wikipedia)

<https://en.wikipedia.org/wiki/Kinect>



How Microsoft Kinect works with Infrared

<https://www.youtube.com/watch?v=dTKINGSH9Po>



パッシブステレオ法 / Passive Stereo

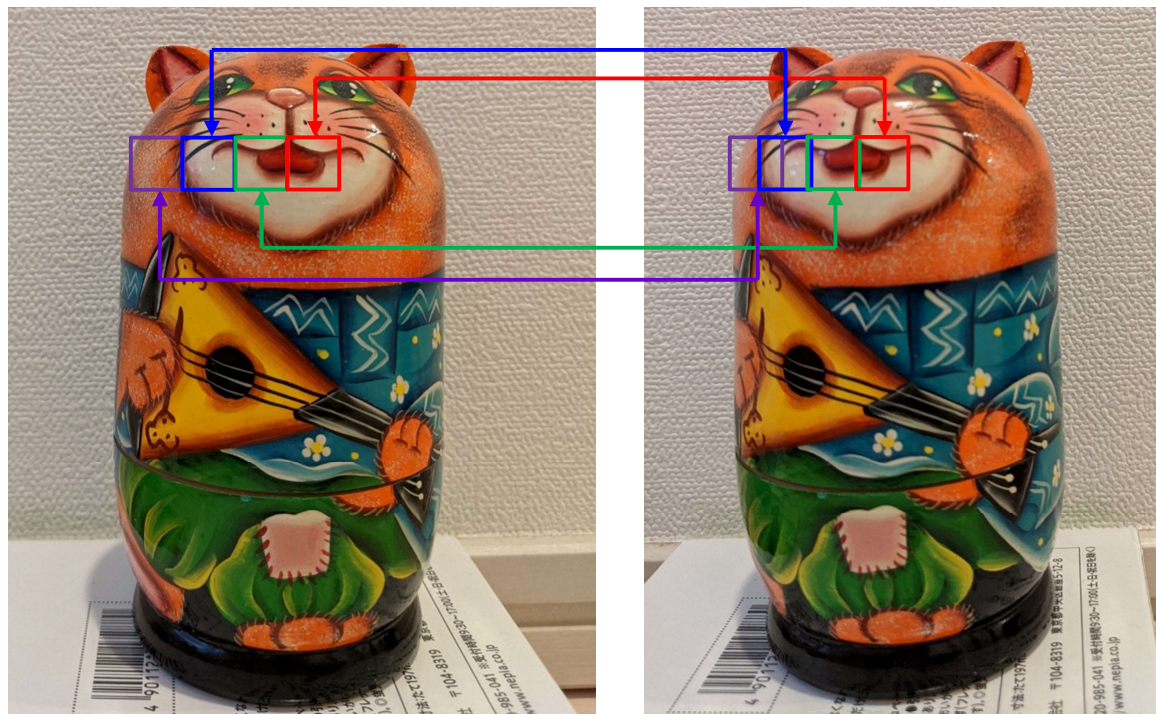

- Two or more cameras
 - Just like we do with our two eyes.
 - Use disparity. Triangular Method.
 - (bad) Disparity measurement requires huge calculus.
 - (bad) Mis-calculation of the disparity occasionally.
 - (good) **Can be used outdoors.**



Passive Stereo example

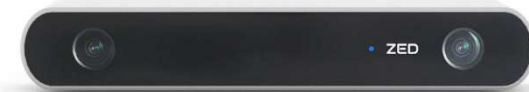

<https://www.stereolabs.com/zed/>

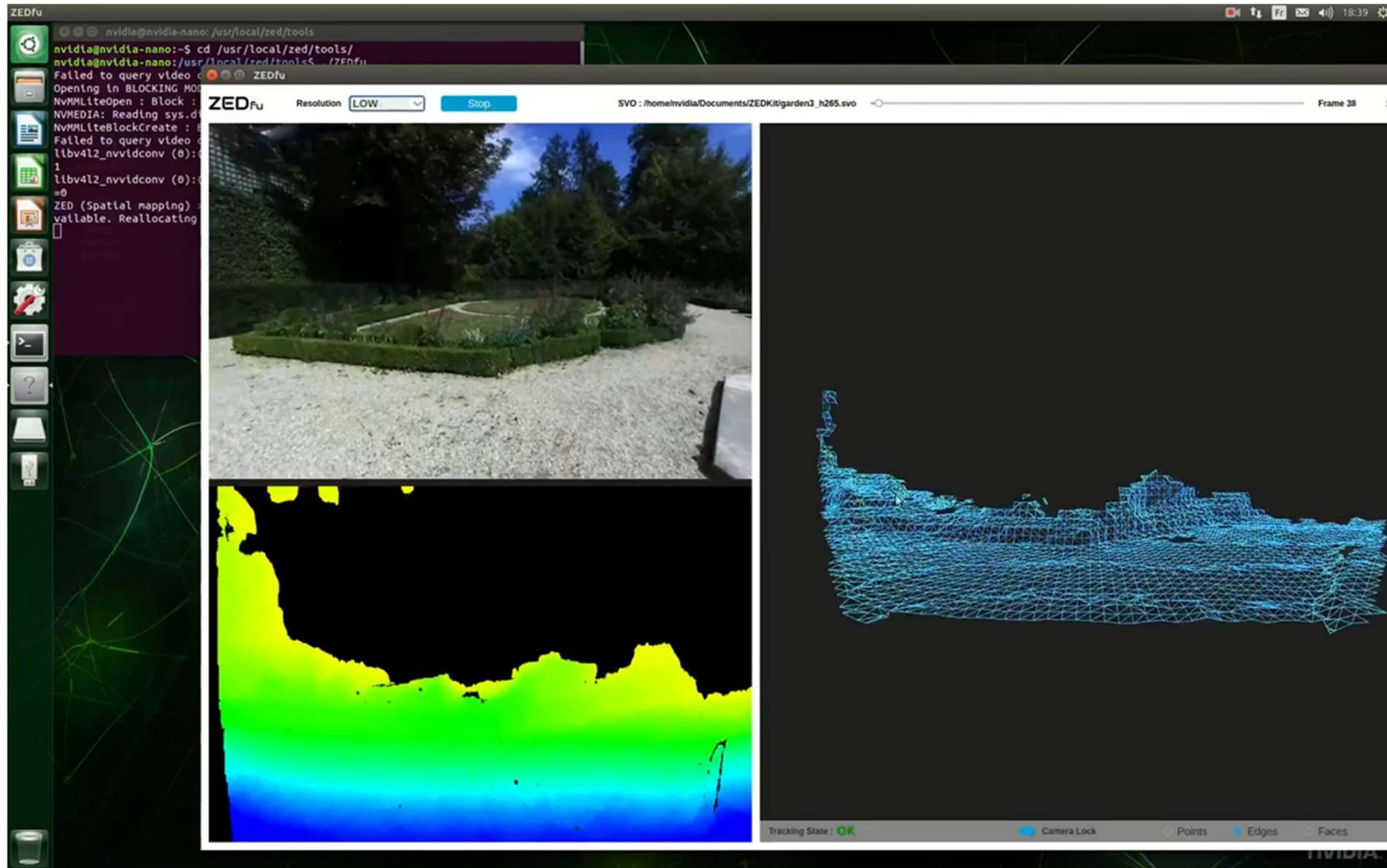

<https://www.youtube.com/watch?v=c7UQ6BQJncM>
3D Mapping on Jetson Nano with ZED Camera



Passive Stereo example: LeapMotion

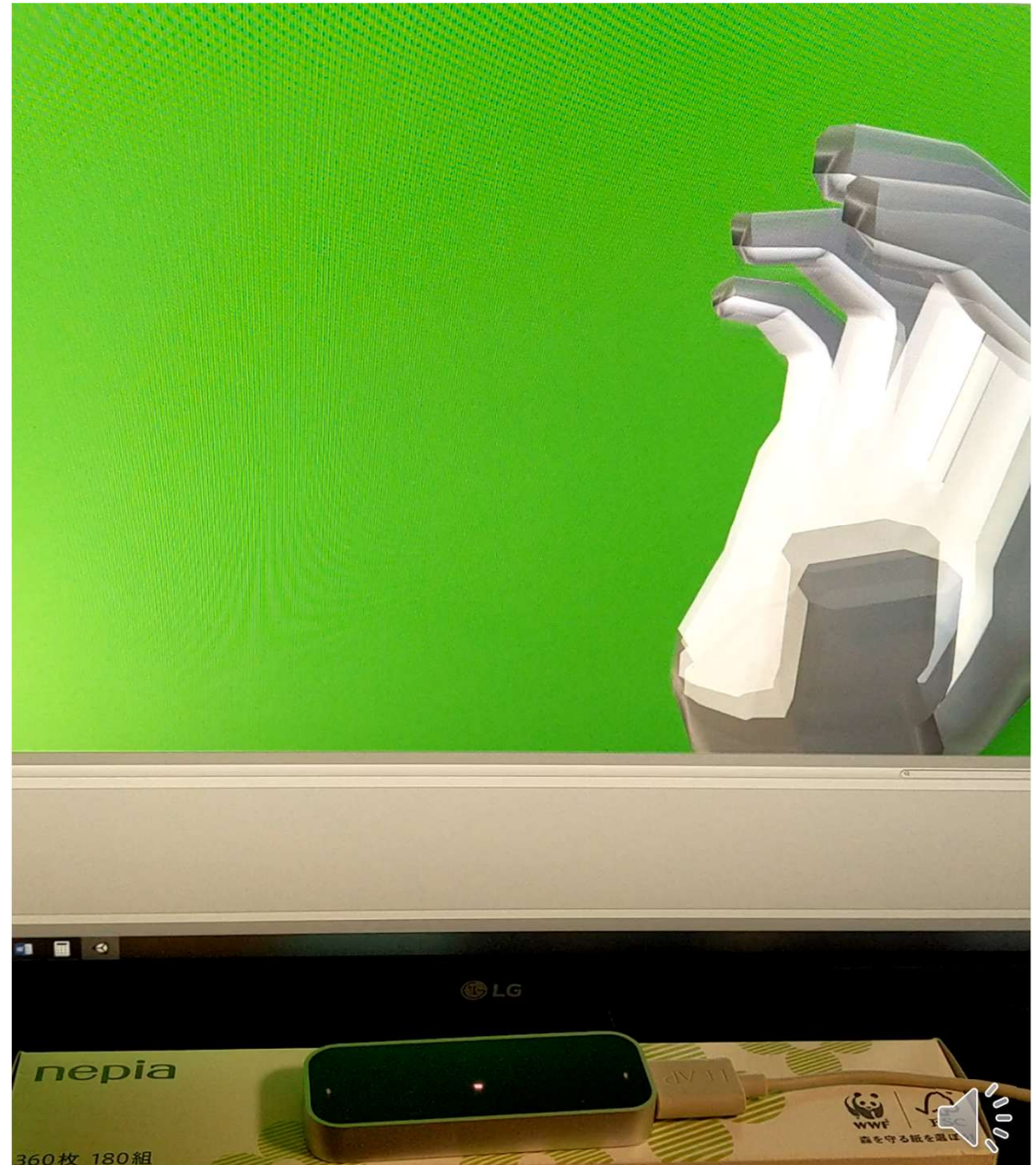

(IEEEVR2021 Poster) Tianyu Wu, Benjamin Watson
Multiscale Sensor Fusion for Display-Centered Head Tracking

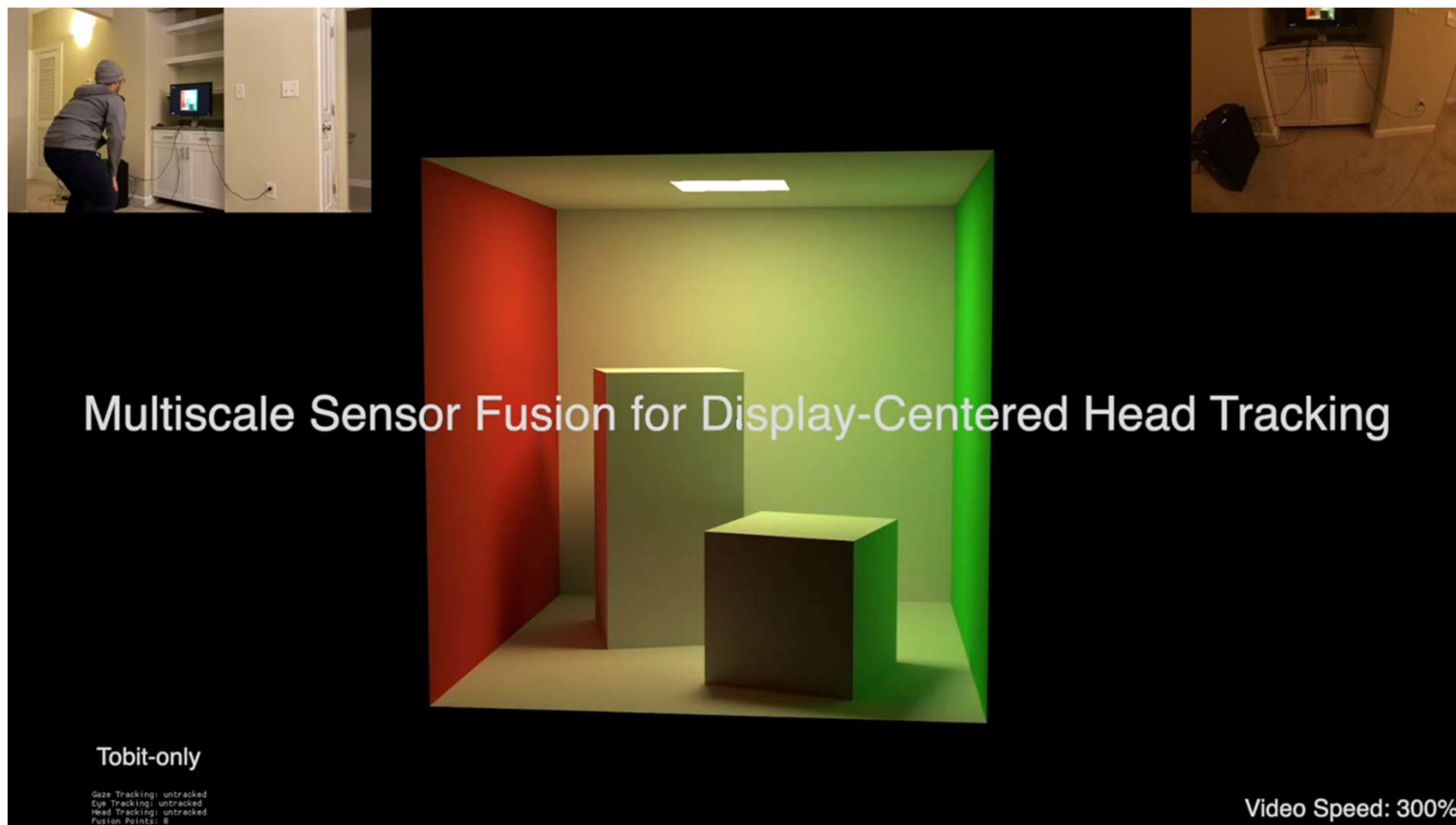

<https://www.youtube.com/watch?v=yWSCgsXHzO4>

- KinectとTobii(眼球運動計測)を組み合わせると、頭部位置の広範囲の動きに対応したディスプレイ映像の表示ができるようになる。
- The combination of Kinect and Tobii (eye movement measurement) will enable the display images to respond to a wide range of head position movements.



視体積交差法 / Visual Cone Intersection, Visual Hull

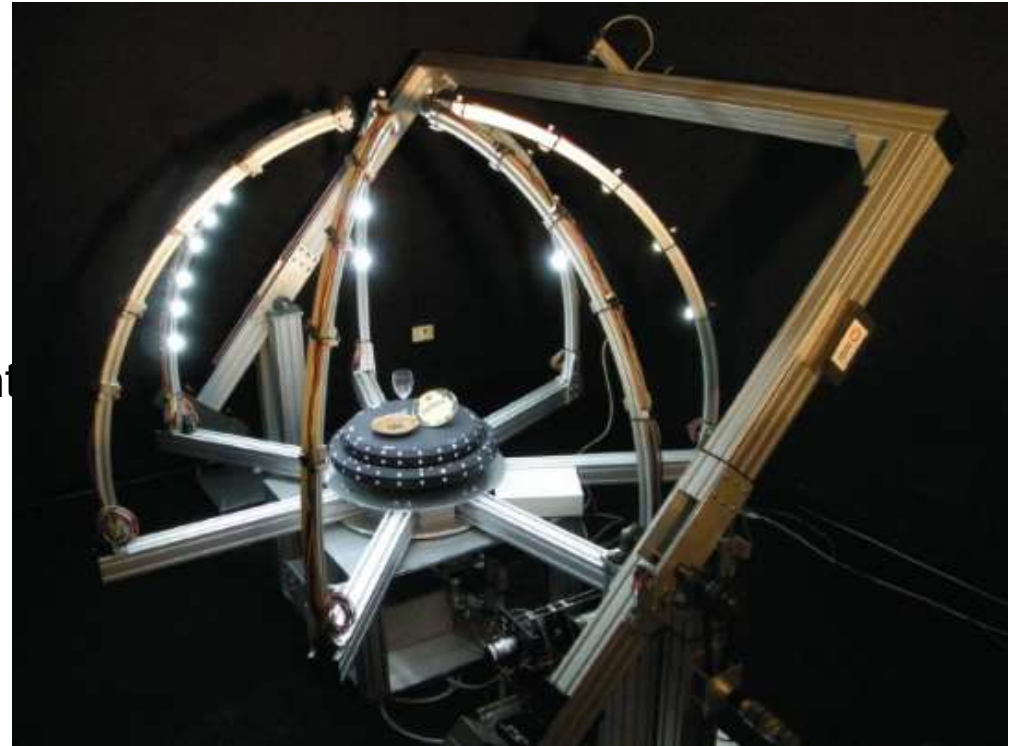
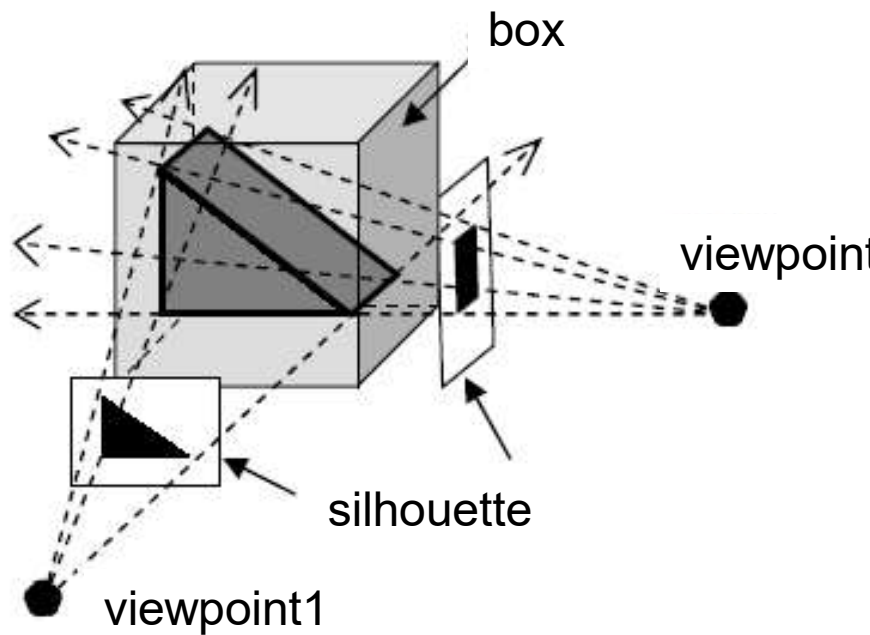

<http://vision.gel.ulaval.ca/~visualhull/>

- Simple method when image can be captured from all-round.
- “trim” the box by using silhouettes.
- (bad) Concave part cannot be reconstructed.



Visual Hull

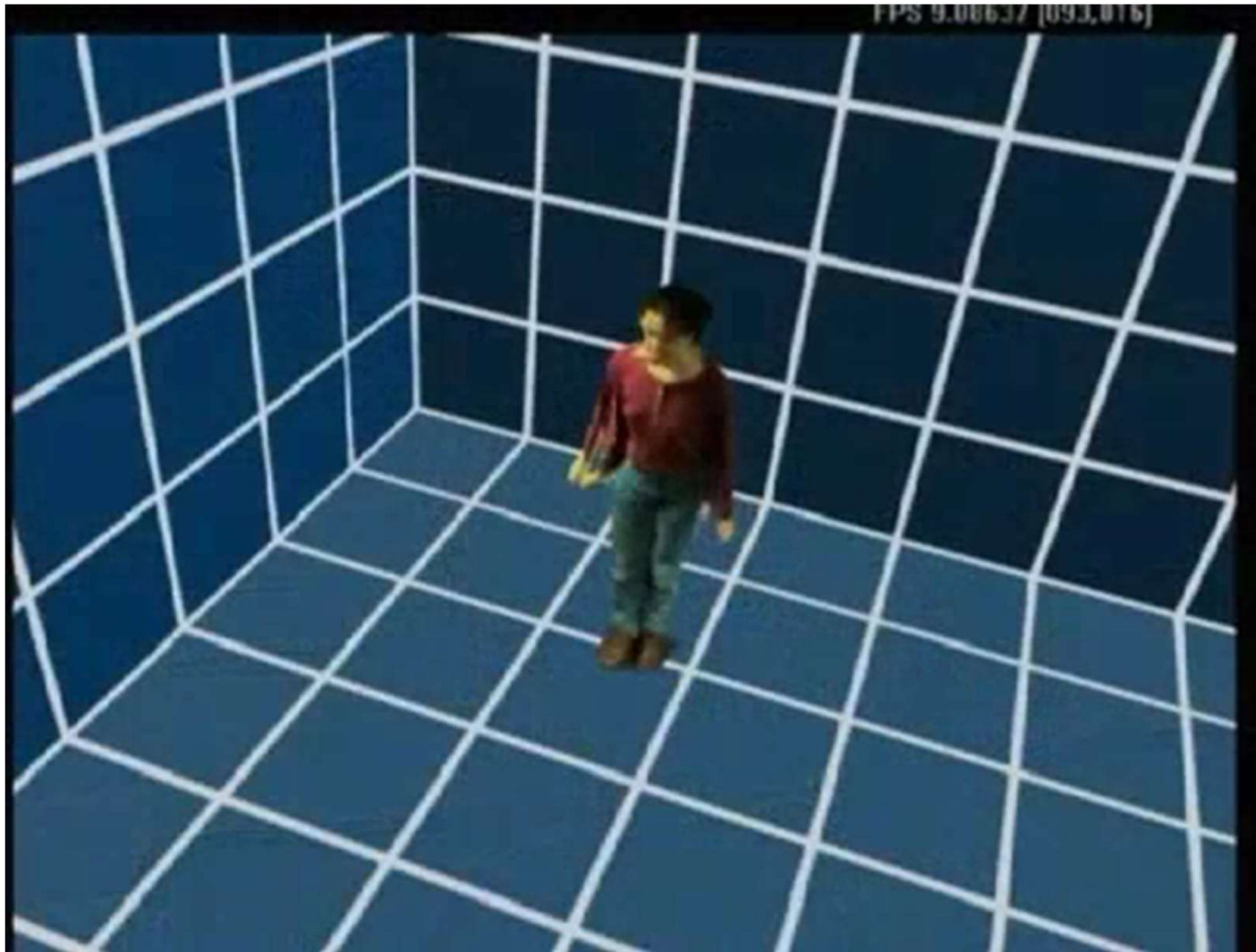

- <https://www.youtube.com/watch?v=Lw9aFaHobao>
- Image-based visual hulls
- Multiple cameras from ceiling enables 3D reconstruction.



照度差ステレオ法 / Photometric Stereo

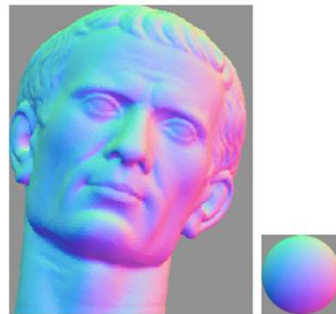
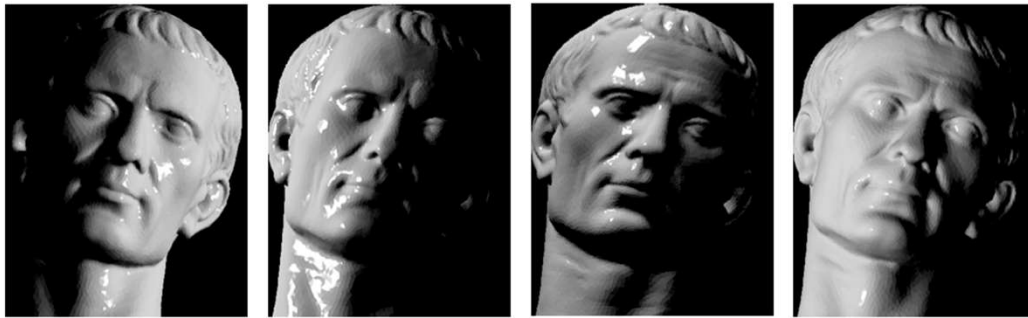

Photometric stereo
https://en.wikipedia.org/wiki/Photometric_stereo

- Prepare 3 or more light sources.
- Object's gradient is calculated by Luminance change
- Shape is calculated by integrating gradient.
- Object surface's characteristics are commonly necessary.
- Single image version is known as shape from shading.

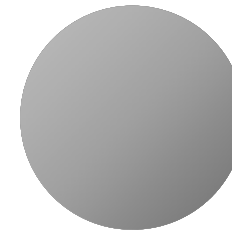

レンズ焦点法 / Shape (depth) from Focus

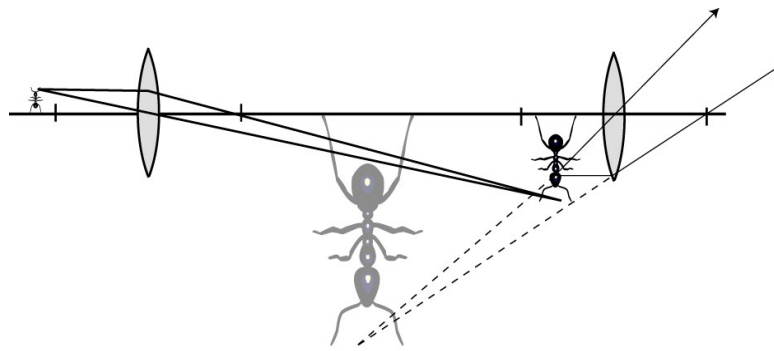

First Experiment in Depth from Focus

<https://www.youtube.com/watch?v=YkjCZTAzIsA&t=180s>

- Shift the lens and move focus distance
- Use different focus levels to obtain a sequence of object images.
- Quite rough, when used for scenary. (focal depth is large)
- Quite accurate, when used in microscopy. (focus is severe)

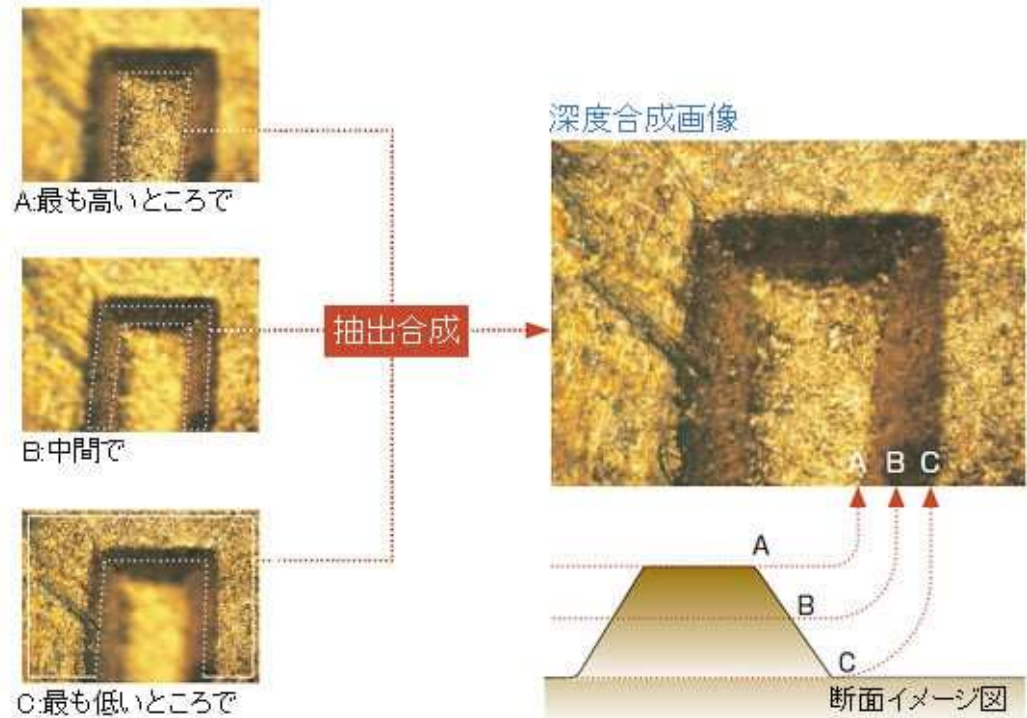

<https://www.keyence.co.jp/ss/products/microscope/beginner/technology/depth-composition.jsp>



Direct Time of Flight (dToF)



<http://www.youtube.com/watch?v=1YBoFdL-CLc>

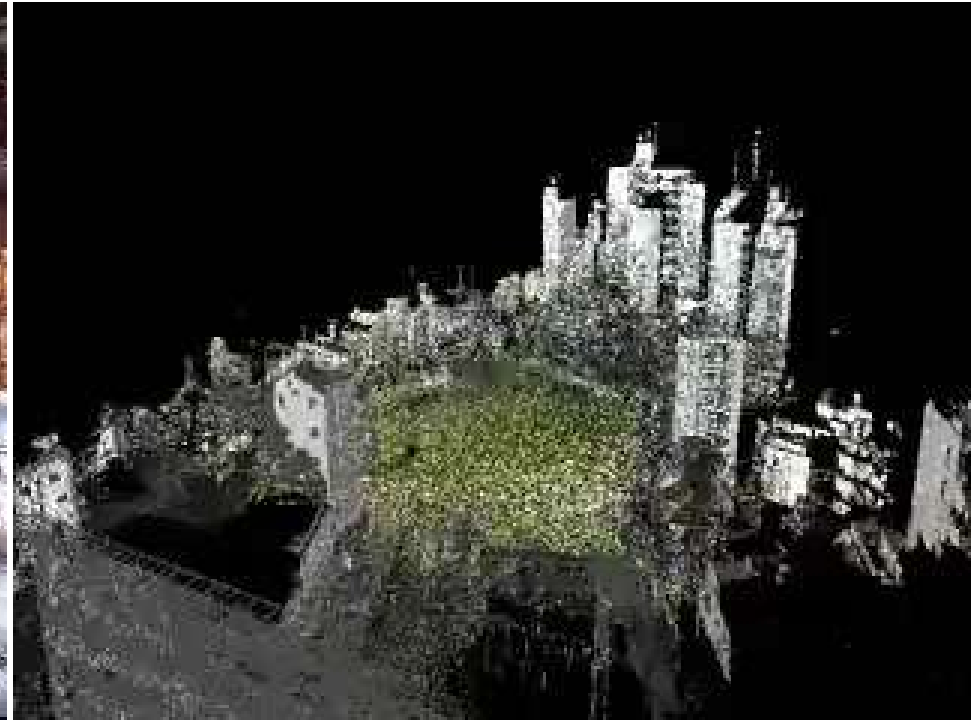

<http://www.youtube.com/watch?v=xmaoKXuMXRw>

- Put laser beam to target.
- Use reflection time and phase-lag
- Use rotating mirror for scanning
- (good) Accurate, long range (long enough for automobiles)
- (bad) Expensive



<https://en.wikipedia.org/wiki/Lidar>

Indirect Time of Flight (iToF)

Time-of-Flight Classification

- **Optical Time of Flight** – round trip estimation of a light wave emitted from the sensor to the targeted object, and then reflected from the object back to the sensor

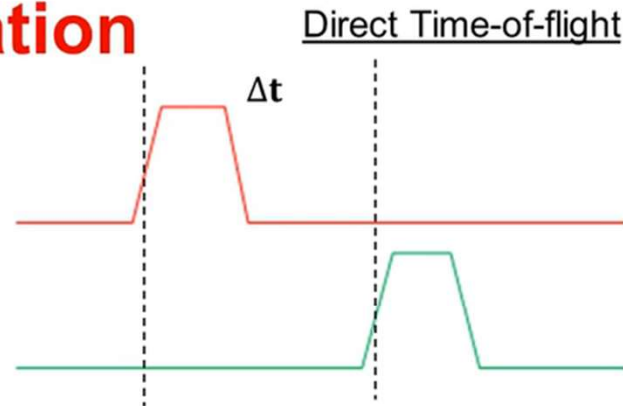
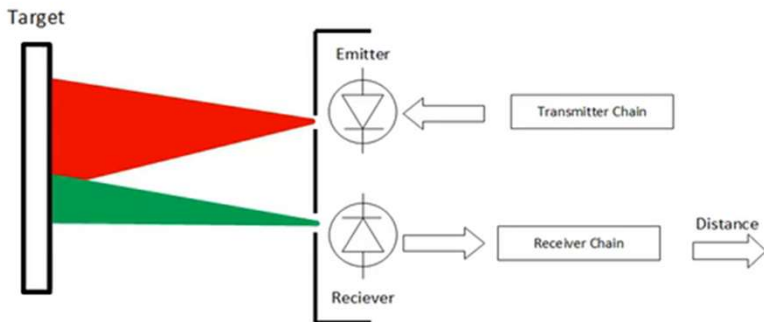

$$d = \frac{c \cdot \Delta t}{2}$$

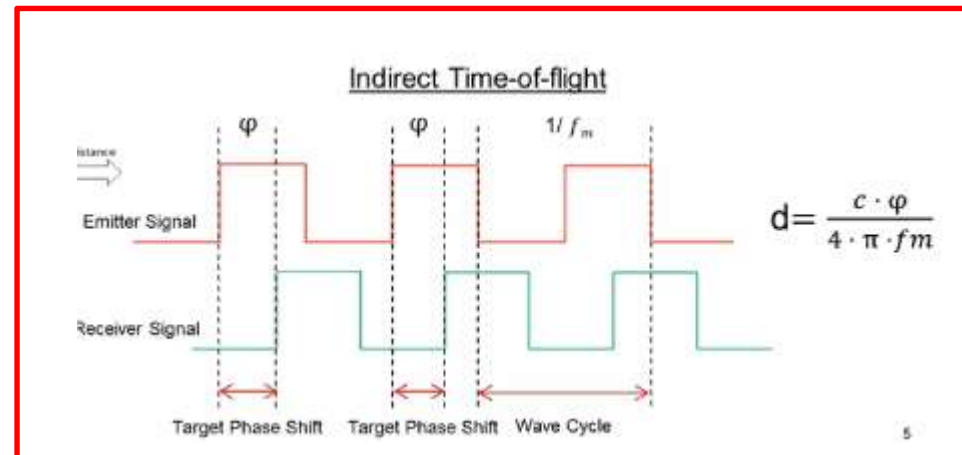

$$d = \frac{c \cdot \phi}{4 \cdot \pi \cdot f_m}$$

- <https://www.youtube.com/watch?v=TpjnooXhOmY>
- Similar to optical radar, but measures phase shift.
- Cheaper.
- Close range. Not suitable for outdoor use.



Xbox Kinect (ver.2) (2014) adopted ToF (iToF)



Kinect v2 (Wikipedia)
<https://en.wikipedia.org/wiki/Kinect>



Kinect V1 Vs Kinect V2

<https://www.youtube.com/watch?v=Zx2E19IV2zs>



モバイル機器に搭載される奥行きカメラ depth sensing in mobile.

Google's Project Tango, 2014~

- 第一世代: Laser, Structured Light (Prime Sense)
- 第二世代: Laser, Structured Light (Mantis Vision)
- 第三世代: IR, Time of Flight

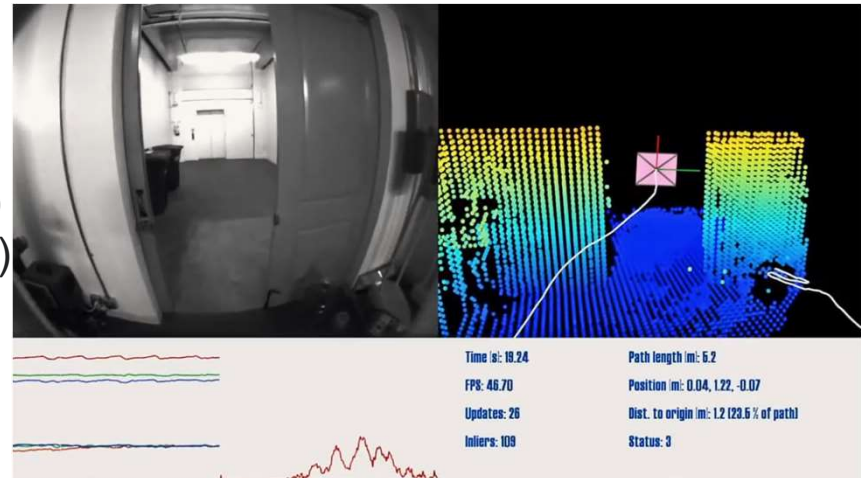

<https://www.youtube.com/watch?v=Qe10ExwzCqk>



<https://www.youtube.com/watch?v=sj3EhvFCY6c>

Huawei P10, 2017~



Double lens camera for post processing

<https://www.digitaltrends.com/mobile/huawei-p10-vs-huawei-p10-plus/>

- スマートフォンでは奥行き計測そのものより画像の被写界深度を擬似的に浅くするために奥行き検出を必要とした。しかし画像処理技術のみで同レベルの処理を行うアプローチも成功 (Google Pixel)
- またARアプリのために奥行き計測が必要であることが再認識。
- Smartphones required depth detection to allow depth of field modulation. An approach that uses only image processing to perform the same level of processing was also successful (Google Pixel). Also, the necessity of depth measurement for AR applications was reaffirmed.

LIDAR in iPhone(2020-)



- スマートフォンとしてははじめて、dToFを採用(iToFを使ったものは以前にも存在)
- これにより測定距離が長くなり、屋内モデリングなどにも使えるものに。
- The first smartphone to use dToF (iToF has been used before).
- This increases the measurement distance and makes it usable for indoor modeling.



3D Lab.

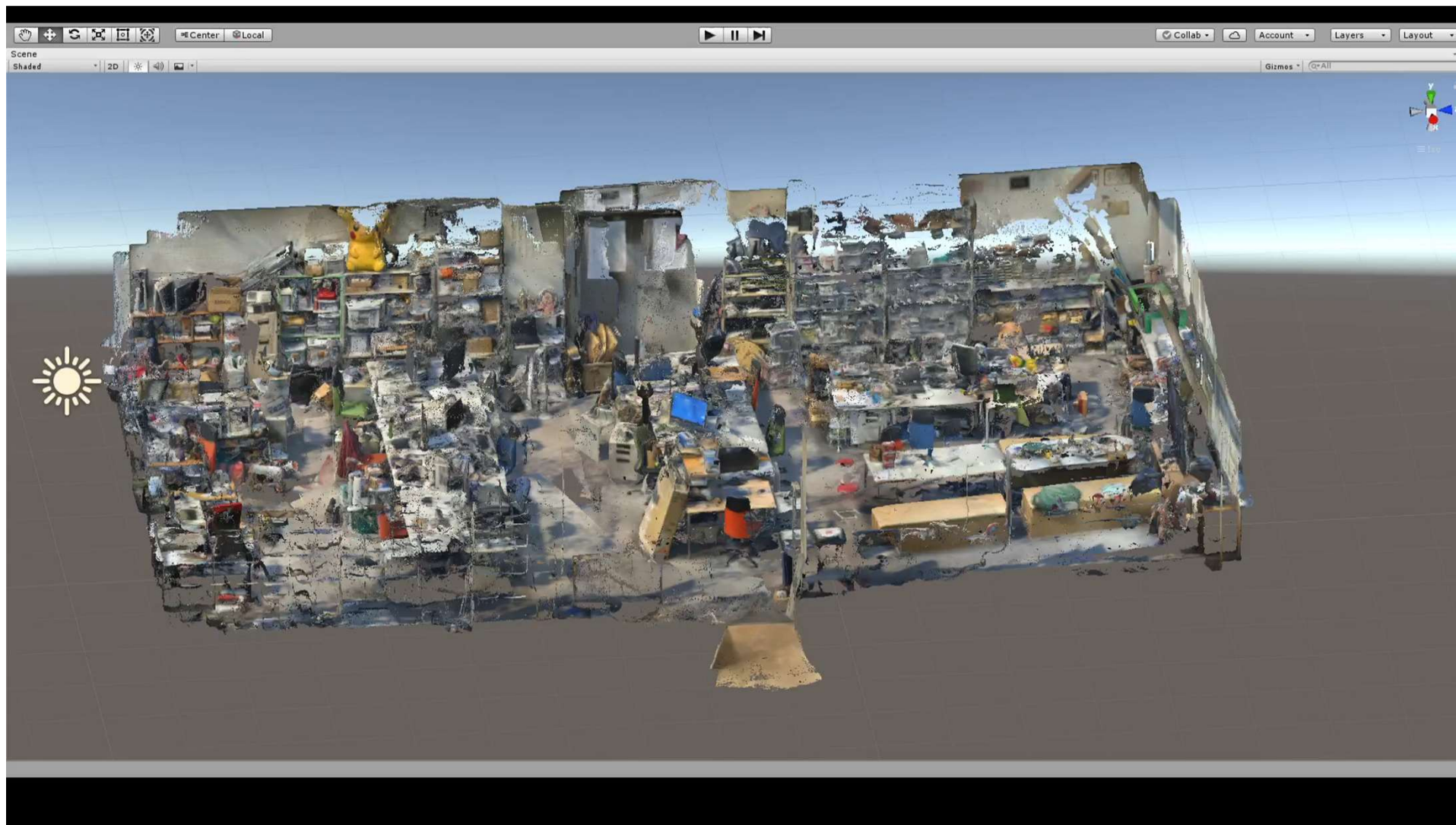

TODAY'S SUMMARY

- Basics of Optics
 - Lens
 - Real Image, Virtual Image
 - Refraction Image, Reflection Image
 - Mirror (flat, elliptic, hyperbolic, parabolic)
- 3D Image Sensing
 - True 3D reconstruction
 - Optical Radar, Time of Flight, Moire Fringe Analysis, Photometric Stereo, Light Section, Shape from Focus, Passive Stereo, Visual Cone Intersection
 - Practical Approach for interactive system



小テスト：一週間以内に提出

Mini Test: Submit in one week

以下の全てに100字以内程度で解答せよ／Answer all questions within 50 words

1. フレネルレンズについて説明せよ Explain fresnel lens.
2. ハーフミラーについて説明せよ Explain half mirror
3. 偏光板について説明せよ Explain polarization plate
4. 実像について説明せよ Explain real image.
5. 虚像について説明せよ Explain virtual image
6. 再帰性反射材について説明せよ Explain retroreflector.
7. モワレ法について説明せよ Explain moire fringe analysis
8. 照度差ステレオ法について説明せよ Explain photometric stereo method
9. 光切断法について説明せよ Explain light section method.
10. タイムオブフライトについて説明せよ Explain time of flight method
11. レンズ焦点法について説明せよ Explain shape from focus
12. パッシブステレオ法について説明せよ Explain passive stereo method
13. 視体積交差法について説明せよ Explain visual cone intersection method.



実験レポート： pdf形式で一週間以内に提出

Experiment Report: Submit in one week (pdf)

簡単なカメラを作成する。材料は焦点距離10-20cm程度の凸レンズ、トイレットペーパーの芯2個程度、コンビニの白ビニール袋である。凸レンズは例えば度数3.5の老眼鏡を百均で購入し、レンズを外し、重ねても良い。

太陽光等によりレンズの焦点距離を計測し、それに基づいた筐体を作成する。焦点距離は変更できることが望ましい。白ビニール袋はスクリーンとして用いる。太陽は絶対に覗かないこと。

レポートでは作成の過程、遠方、中距離(数m)、近距離(1m以内)での動作の様子などを記載する。

Create a simple camera. The materials are a convex lens with a focal length of 10-20cm, two toilet paper cores, and a white plastic bag. For the convex lens, you can buy reading glasses with a power of 3.5 at a hundred-yen store, take the lenses, and stack them on top of each other. Measure the focal length of the lens using sunlight, etc., and design a housing based on that. The focal length should be changeable. The white plastic bag shall be used as a screen. Do not look at the sun. The report should describe the process of creation and how it works at far distance, medium (several meters), and short distance (within 1 meter).





Toilet paper cores
Reading glass bought at 100均
White plastic bag

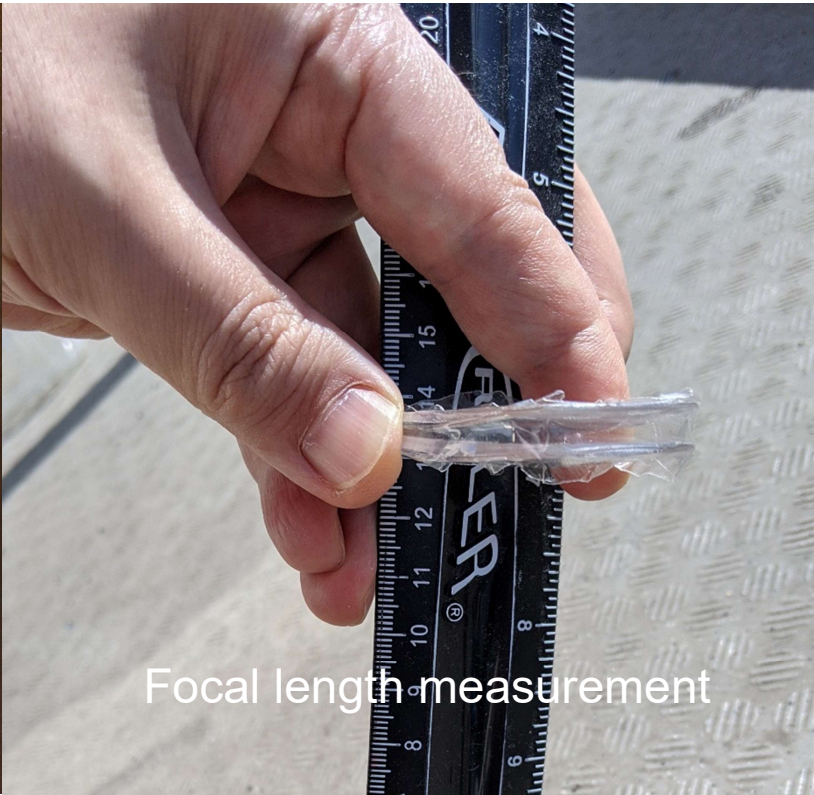

Focal length measurement



Stacking the two glasses

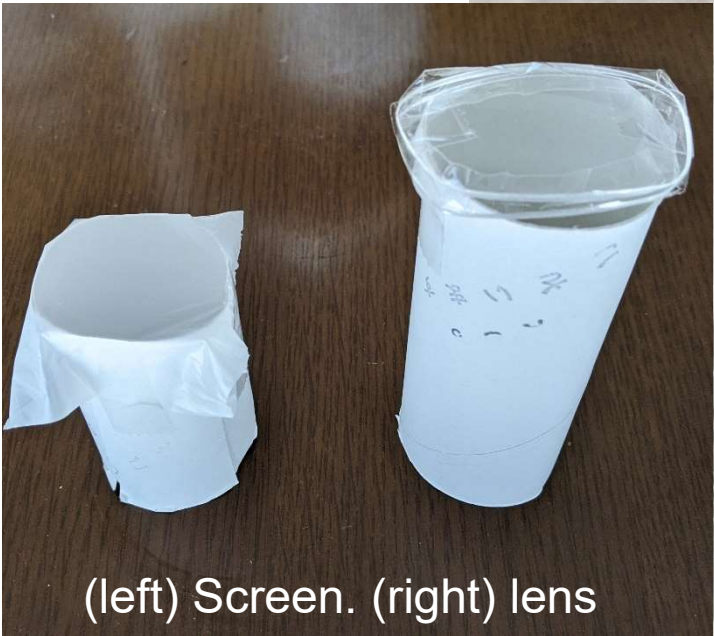

(left) Screen. (right) lens



Focus-adjustable camera



Room light



Distant sight

